

DrayTek

VigorLTE 200 Series

LTE Router



USER'S GUIDE

V1.0

VigorLTE 200 Series LTE Router

User's Guide

Version: 1.0

Firmware Version: V3.8.11

(For future update, please visit DrayTek web site)

Date: May 2, 2019

Copyrights

© All rights reserved. This publication contains information that is protected by copyright. No part may be reproduced, transmitted, transcribed, stored in a retrieval system, or translated into any language without written permission from the copyright holders.

Trademarks

The following trademarks are used in this document:

- Microsoft is a registered trademark of Microsoft Corp.
- Windows, Windows 95, 98, Me, NT, 2000, XP, Vista, 7 and Explorer are trademarks of Microsoft Corp.
- Apple and Mac OS are registered trademarks of Apple Inc.
- Other products may be trademarks or registered trademarks of their respective manufacturers.

Safety Instructions

- Read the installation guide thoroughly before you set up the router.
- The router is a complicated electronic unit that may be repaired only by authorized and qualified personnel. Do not try to open or repair the router yourself.
- Do not place the router in a damp or humid place, e.g. a bathroom.
- The router should be used in a sheltered area, within a temperature range of +5 to +40 Celsius.
- Do not expose the router to direct sunlight or other heat sources. The housing and electronic components may be damaged by direct sunlight or heat sources.
- Do not deploy the cable for LAN connection outdoor to prevent electronic shock hazards.
- Keep the package out of reach of children.
- When you want to dispose of the router, please follow local regulations on conservation of the environment.

Warranty

- We warrant to the original end user (purchaser) that the router will be free from any defects in workmanship or materials for a period of two (2) years from the date of purchase from the dealer. Please keep your purchase receipt in a safe place as it serves as proof of date of purchase. During the warranty period, and upon proof of purchase, should the product have indications of failure due to faulty workmanship and/or materials, we will, at our discretion, repair or replace the defective products or components, without charge for either parts or labor, to whatever extent we deem necessary to restore the product to proper operating condition. Any replacement will consist of a new or re-manufactured functionally equivalent product of equal value, and will be offered solely at our discretion. This warranty will not apply if the product is modified, misused, tampered with, damaged by an act of God, or subjected to abnormal working conditions. The warranty does not cover the bundled or licensed software of other vendors. Defects which do not significantly affect the usability of the product will not be covered by the warranty. We reserve the right to revise the manual and online documentation and to make changes from time to time in the contents hereof without obligation to notify any person of such revision or changes.

Be a Registered Owner

- Web registration is preferred. You can register your Vigor router via <http://www.DrayTek.com>.

Firmware & Tools Updates

- Due to the continuous evolution of DrayTek technology, all routers will be regularly upgraded. Please consult the DrayTek web site for more information on newest firmware, tools and documents.

More update, please visit www.draytek.com.

Table of Contents

Part I Installation	i
I-1 Introduction	1
I-1-1 Indicators and Connectors	2
I-2 Hardware Installation	4
I-2-1 Network Connection via LTE	4
I-2-2 Wall-Mounted Installation	5
I-3 Accessing Web Page	6
I-4 Changing Password	8
I-5 Dashboard	9
I-5-1 Virtual Panel	10
I-5-2 Name with a Link	10
I-5-3 Quick Access for Common Used Menu	11
I-5-4 GUI Map	12
I-5-5 Web Console	13
I-5-6 Config Backup	13
I-5-7 Logout	14
I-5-8 Online Status	14
I-5-8-1 Physical Connection	14
I-5-8-2 Virtual WAN	16
I-6 Quick Start Wizard	17
I-6-1 LTE	18
I-6-2 WAN2 (Ethernet)	20
I-7 Service Activation Wizard	29
I-8 Registering Vigor Router	31
Part II Connectivity	33
II-1 LTE	34
Web User Interface	35
II-1-1 General Settings	35
II-1-1-1 SMS Quota	35
II-1-1-2 SMS Inbox Policy	36
II-1-2 SMS Inbox	37
II-1-3 Send SMS	40
II-1-4 Router Commands	41
II-1-5 Status	43
II-2 WAN	45
Web User Interface	46
II-2-1 General Setup	46
II-2-1-1 LTE	47
II-2-1-2 WAN2	47
II-2-2 Internet Access	49

II-2-2-1 Details Page for 3G/4G LTE Modem (DHCP mode) in LTE WAN.....	50
II-2-2-2 Details Page for PPPoE in WAN2.....	54
II-2-2-3 Details Page for Static or Dynamic IP in WAN2	56
II-2-2-4 Details Page for PPTP	60
II-2-2-5 Details Page for IPv6 - Offline.....	62
II-2-2-6 Details Page for IPv6 - PPP	62
II-2-2-7 Details Page for IPv6 - TSPC.....	63
II-2-2-8 Details Page for IPv6 - AICCU	65
II-2-2-9 Details Page for IPv6 - DHCPv6 Client	66
II-2-2-10 Details Page for IPv6 - Static IPv6	67
II-2-2-11 Details Page for IPv6 - 6in4 Static Tunnel.....	68
II-2-2-12 Details Page for IPv6 - 6rd	70
II-2-3 Multi-PVC/VLAN.....	72
Application Notes	76
A-1 How to configure IPv6 on WAN interface?.....	76
II-3 LAN	81
Web User Interface	83
II-3-1 General Setup	83
II-3-1-1 Details Page for LAN1 - Ethernet TCP/IP and DHCP Setup	85
II-3-1-2 Details Page for LAN2	87
II-3-1-3 Details Page for IP Routed Subnet	89
II-3-1-4 Details Page for LAN IPv6 Setup	91
II-3-1-5 Advanced DHCP Options	94
II-3-2 VLAN	96
II-3-3 Bind IP to MAC	99
II-4 NAT	102
Web User Interface	103
II-4-1 Port Redirection.....	103
II-4-2 DMZ Host	107
II-4-3 Open Ports	110
II-4-4 ALG.....	112
II-5 Applications	114
Web User Interface	115
II-5-1 Dynamic DNS	115
II-5-2 Schedule.....	118
II-5-3 RADIUS	121
II-5-4 UPnP	122
II-5-5 IGMP.....	123
II-5-5-1 General Setting	123
II-5-5-2 Working Group	124
II-5-6 SMS Alert Service	125
Application Notes	126
A-1 How to use DrayDDNS?.....	126
A-2 How to Configure Customized DDNS?.....	131
II-6 Routing.....	135
Web User Interface	136
II-6-1 Static Route	136

Part III Wireless LAN.....	141
III-1 Wireless LAN	142
Web User Interface	146
III-1-1 Wireless Wizard.....	146
III-1-2 General Setup	149
III-1-3 Security.....	151
III-1-4 Access Control	153
III-1-5 WPS.....	155
III-1-6 WDS	156
III-1-7 Advanced Setting	159
III-1-8 AP Discovery	162
III-1-9 Station List.....	163
Part IV VPN.....	165
IV-1 VPN and Remote Access	166
Web User Interface	167
IV-1-1 VPN Client Wizard	167
IV-1-2 VPN Server Wizard	173
IV-1-3 Remote Access Control	177
IV-1-4 PPP General Setup.....	178
IV-1-5 IPsec General Setup	180
IV-1-6 IPsec Peer Identity	182
IV-1-7 Remote Dial-in User	184
IV-1-8 LAN to LAN	187
IV-1-9 Connection Management.....	197
IV-2 SSL VPN	198
Web User Interface	199
IV-2-1 General Setup	199
IV-2-2 User Account.....	200
IV-2-3 SSL Portal Online User	204
IV-3 Certificate Management.....	205
Web User Interface	206
IV-3-1 Local Certificate	206
IV-3-2 Trusted CA Certificate.....	210
IV-3-3 Certificate Backup	212
Part V Security	213
V-1 Firewall.....	214
Web User Interface	216
V-1-1 General Setup	216
V-1-2 Filter Setup.....	221
V-1-3 DoS Defense	230

V-1-3-1 DoS Defense	230
V-1-3-2 Spoofing Defense	233
Application Notes	234
A-1 How to Configure Certain Computers Accessing to Internet	234
V-2 Central Security Management (CSM)	238
Web User Interface	239
V-2-1 APP Enforcement Profile	239
V-2-2 URL Content Filter Profile	241
V-2-3 Web Content Filter Profile	245
Application Notes	249
A-1 How to Create an Account for MyVigor	249
A-2 How to Block Facebook Service Accessed by the Users via Web Content Filter / URL Content Filter	254
Part VI Management	259
VI-1 System Maintenance	260
Web User Interface	261
VI-1-1 System Status	261
VI-1-2 TR-069	263
VI-1-3 Administrator Password	265
VI-1-4 User Password	266
VI-1-5 Configuration Backup	268
VI-1-6 Syslog/Mail Alert	270
VI-1-7 Time and Date	272
VI-1-8 SNMP	273
VI-1-9 Management	275
VI-1-10 Panel Control	278
VI-1-11 Self-Signed Certificate	279
VI-1-12 Reboot System	281
VI-1-13 Firmware Upgrade	282
VI-1-14 Activation	283
VI-2 Bandwidth Management	285
Web User Interface	287
VI-2-1 Sessions Limit	287
VI-2-2 Bandwidth Limit	289
VI-2-3 Quality of Service	291
Application Notes	298
A-1 How to Optimize the Bandwidth through QoS Technology	298
VI-3 Central Management (AP)	302
Web User Interface	303
VI-3-1 Dashboard	303
VI-3-2 Status	304
VI-3-3 WLAN Profile	305

VI-3-4 AP Maintenance.....	310
VI-3-5 Traffic Graph	311
VI-3-6 Temperature Sensor	312
VI-3-7 Event Log	312
VI-3-8 Total Traffic	313
VI-3-9 Station Number	313
VI-3-10 Load Balance	314
Part VII Others.....	317
VII-1 Objects Settings.....	318
Web User Interface	319
VII-1-1 IP Object	319
VII-1-2 IP Group.....	323
VII-1-3 IPv6 Object.....	324
VII-1-4 IPv6 Group	326
VII-1-5 Service Type Object.....	327
VII-1-6 Service Type Group	329
VII-1-7 Keyword Object.....	331
VII-1-8 Keyword Group	333
VII-1-9 File Extension Object	334
VII-1-10 SMS Service Object.....	336
VII-1-11 Notification Object.....	339
VII-1-12 String Object	341
Application Notes	342
<i>A-1 How to Send a Notification to Specified Phone Number via SMS Service in WAN</i>	
<i>Disconnection</i>	<i>342</i>
Part VIII Troubleshooting	347
VIII-1 Diagnostics	348
Web User Interface	349
VIII-1-1 Dial-out Triggering.....	349
VIII-1-2 Routing Table.....	350
VIII-1-3 ARP Cache Table	351
VIII-1-4 IPv6 Neighbour Table	352
VIII-1-5 DHCP Table	353
VIII-1-6 NAT Sessions Table	354
VIII-1-7 DNS Cache Table	355
VIII-1-8 Ping Diagnosis	356
VIII-1-9 Data Flow Monitor	357
VIII-1-10 Traffic Graph	360
VIII-1-11 Trace Route	361
VIII-1-12 Syslog Explorer	362

VIII-1-13 IPv6 TSPC Status	363
VIII-1-14 DoS Flood Table	364
VIII-2 Checking If the Hardware Status Is OK or Not	366
VIII-3 Checking If the Network Connection Settings on Your Computer Is OK or Not.....	367
VIII-4 Pinging the Router from Your Computer	370
VIII-5 Checking If the ISP Settings are OK or Not	372
VIII-6 Backing to Factory Default Setting If Necessary	373
VIII-7 Contacting DrayTek	374
Part IX Telnet Commands.....	375
Accessing Telnet of VigorLTE 200.....	376
Index	556

Part I Installation



Installation

This part will introduce Vigor router and guide to install the device in hardware and software.

I-1 Introduction

This is a generic International version of the user guide. Specification, compatibility and features vary by region. For specific user guides suitable for your region or product, please contact local distributor.

VigorLTE 200 series is a router equipped with an LTE module which allows you to access the Internet via a SIM card.

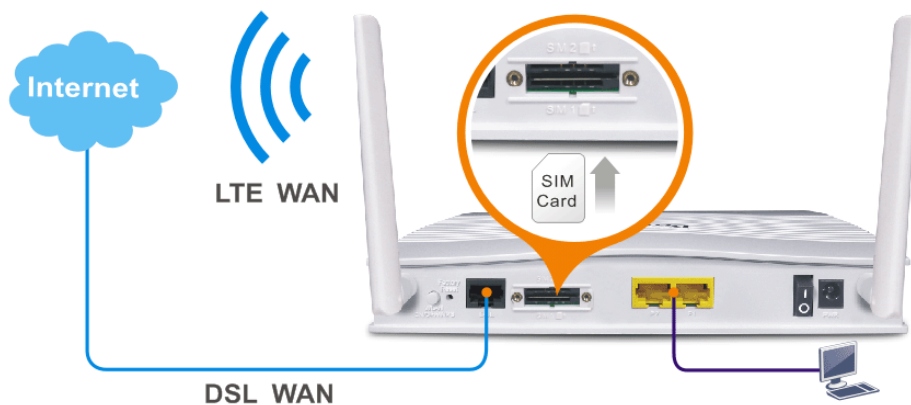

It integrates IP layer QoS, NAT session/bandwidth management to help users control works well with large bandwidth. By adopting hardware-based VPN platform and hardware encryption of AES/DES/3DES, the router increases the performance of VPN greatly, and offers several protocols (such as IPSec/PPTP/L2TP) with VPN tunnels.

The object-based design used in SPI (Stateful Packet Inspection) firewall allows users to set firewall policy with ease. CSM (Content Security Management) provides users control and management in IM (Instant Messenger) and P2P (Peer to Peer) more efficiency than before. By the way, DoS/DDoS prevention and URL/Web content filter strengthen the security outside and control inside. Object-based firewall is flexible and allows your network be safe.

On the Wireless-equipped models each of the wireless SSIDs can also be grouped within one of the VLANs.

VigorLTE 200 series provides two-level management to simplify the configuration of network connection. The user mode allows user accessing into WEB interface via simple configuration. However, if users want to have advanced configurations, they can access into WEB interface through admin mode.

I-1-1 Indicators and Connectors

Before you use the Vigor router, please get acquainted with the LED indicators and connectors first.

VigorLTE 200 / VigorLTE 200n



LED	Status	Explanation
	Off	The router is powered off.
	Blinking	The router is powered on and running normally.
	On	The router is ready to access Internet.
	Off	The router is not ready to access Internet.
	Blinking	Slowly: The DSL connection is ready. Quickly: The DSL connection is establishing.
	On	The LAN port is connected.
	Blinking	The data is transmitting through the LAN port.
	On	LTE device is connected and ready for use.
	Off	LTE device is not detected, or has serious problem (e.g., no SIM card, SIM pin error, SIM deactivated, and etc.).
	Blinking	Vigor device performs initial access procedure.
	On	SIM card is inserted into the slot and detected by Vigor device.
	Blinking	No SIM card in detected.
	On	Wireless function is enabled.
	Off	Wireless function is disabled.
	Blinking	The data is transmitting via wireless connection. Blinks with one second cycle for two minutes. The WPS function is active.

VigorLTE 200,

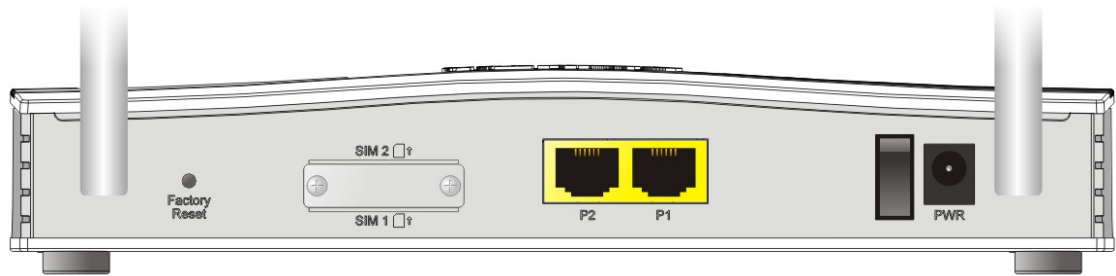

VigorLTE 200n,

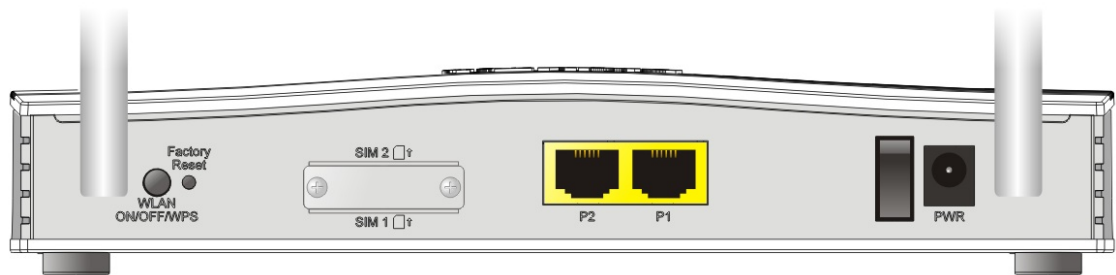

Interface	Description
Factory Reset	Restore the default settings. Usage: Turn on the router (ACT LED is blinking). Press the hole and keep for more than 5 seconds. When you see the ACT LED begins to blink rapidly than usual, release the button. Then the router will restart with the factory default configuration.
SIM2/SIM1	SIM card slot(s).
P2-P1	Connecters for local network devices.
ON/OFF	Power Switch.
PWR	Connector for a power adapter.

I-2 Hardware Installation

I-2-1 Network Connection via LTE

Before starting to configure the router, you have to connect your devices correctly. In this section, VigorLTE 200 is taken as an example.

1. Install the SIM card into the card slot. The back plate of the SIM card slot must be removed first and the direction of card notch must be on the left side.



After installing the SIM card, fasten the back plate again.

2. Connect to your computer with a RJ-45 cable.
3. Connect one end of the power cord to the power port of this device. Connect the other end to the wall outlet of electricity.
4. Power on the router.
5. Check the power, LTE and LAN LEDs to assure network connections.

(For the hardware connection, we take "n" model as an example.)

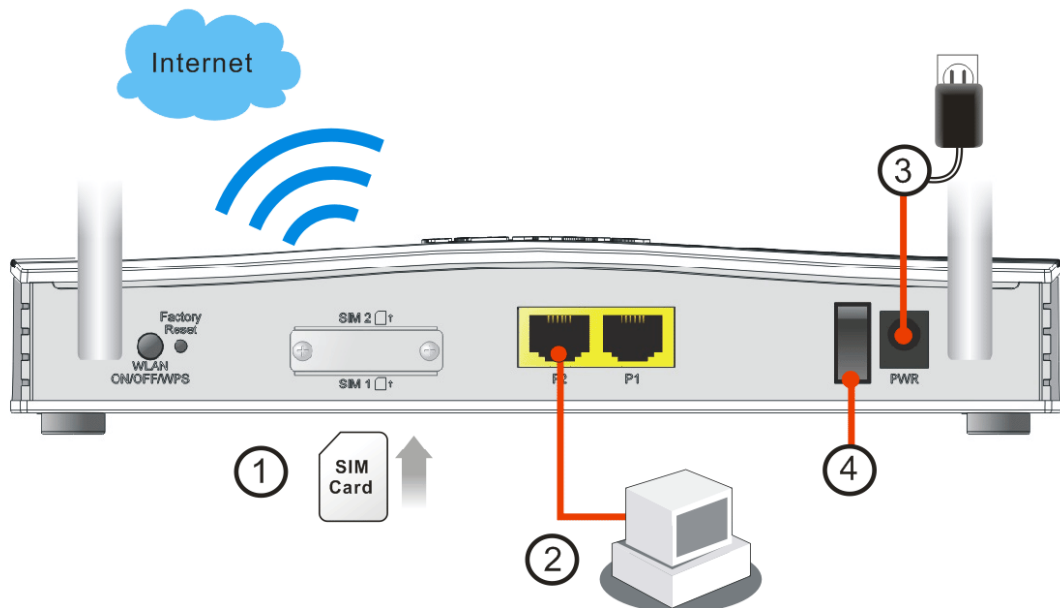

I-2-2 Wall-Mounted Installation

VigorLTE 200 has keyhole type mounting slots on the underside.

1. A template is provided on the VigorLTE 200 packaging box to enable you to space the screws correctly on the wall.
2. Place the template on the wall and drill the holes according to the recommended instruction.
3. Fit screws into the wall using the appropriate type of wall plug.

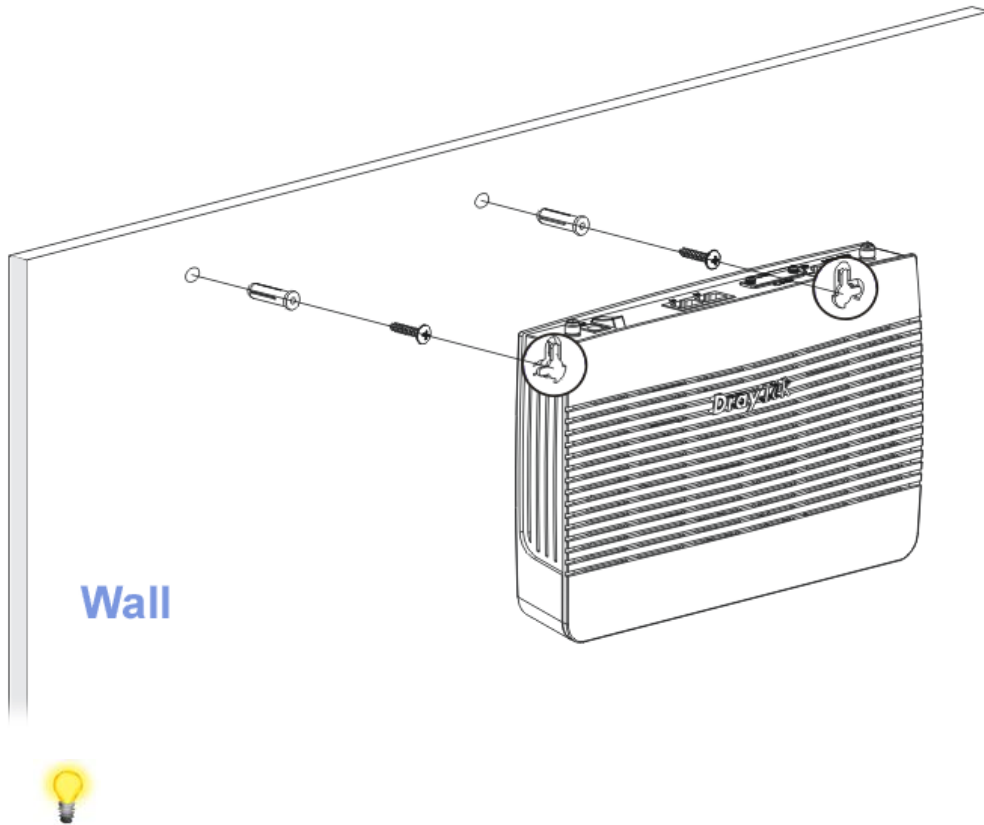

Note

The recommended drill diameter shall be 6.5mm (1/4").

4. When you finished about procedure, the router has been mounted on the wall firmly.

I-3 Accessing Web Page

1. Make sure your PC connects to the router correctly.
You may either simply set up your computer to get IP dynamically from the router or set up the IP address of the computer to be the same subnet as the **default IP address of Vigor router 192.168.1.1**. For the detailed information, please refer to the later section - Trouble Shooting of the guide.
2. Open a web browser on your PC and type **http://192.168.1.1**. The following window will be open to ask for username and password.



DrayTek **VigorLTE 200 Series**

Login

Username

Password

Login

Security Warning: You are logging in without encryption which is not recommended. To login securely [click here](#).

Copyright © 2000- 2018 DrayTek Corp. All Rights Reserved.

3. Please type "admin/admin" as the Username/Password and click **Login**.



Info

If you fail to access to the web configuration, please go to "Trouble Shooting" for detecting and solving your problem.

- Now, the Main Screen will appear. Take VigorLTE 200n as an example.

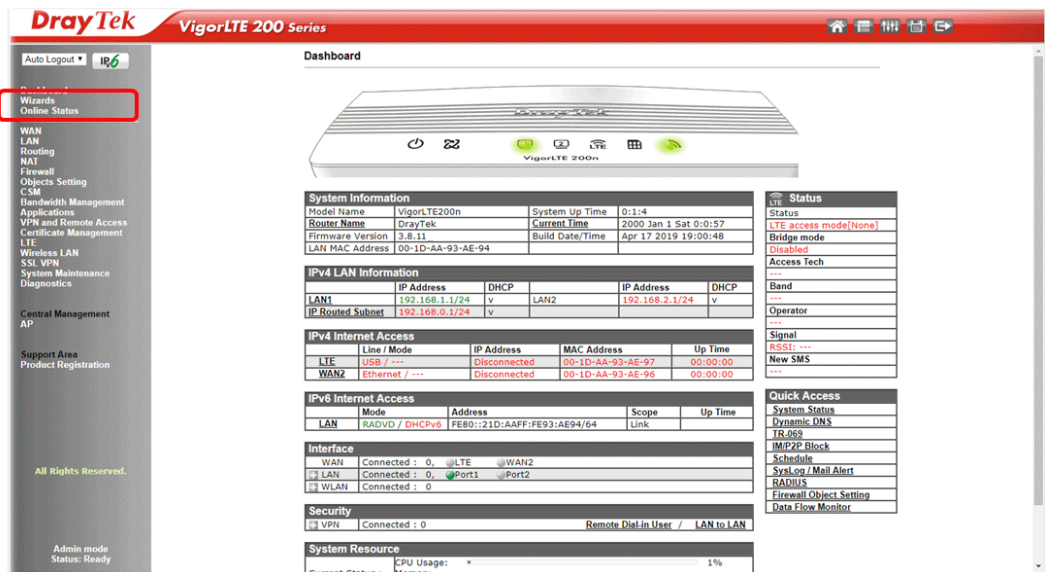

Info

The home page will be different slightly in accordance with the type of the router you have.

- The web page can be logged out according to the chosen condition. The default setting is **Auto Logout**, which means the web configuration system will logout after 5 minutes without any operation. Change the setting for your necessity.

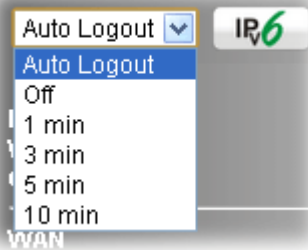

I-4 Changing Password

Please change the password for the original security of the router.

1. Open a web browser on your PC and type **http://192.168.1.1**. A pop-up window will open to ask for username and password.
2. Please type "admin/admin" as Username/Password for accessing into the web user interface with admin mode.
3. Go to **System Maintenance** page and choose **Administrator Password**.

System Maintenance >> Administrator Password Setup

Administrator Password

Old Password	<input type="text"/>	Max: 23 characters
New Password	<input type="text"/>	(Max. 23 characters allowed)
Confirm Password	<input type="text"/>	(Max. 23 characters allowed)

Note:

Password can contain only a-z A-Z 0-9 , ; . " < > * + = | ? @ # ^ ! ()

OK

4. Enter the login password (the default is "admin") on the field of **Old Password**. Type **New Password** and **Confirm Password**. Then click **OK** to continue.



Info

The maximum length of the password you can set is 23 characters.

5. Now, the password has been changed. Next time, use the new password to access the Web user interface for this router.

The image shows the login page for the DrayTek VigorLTE 200 Series. At the top, there is a red banner with the DrayTek logo and "VigorLTE 200 Series". Below the banner, the word "Login" is written in white on a black background. The main area contains two input fields: "Username" and "Password". Below the fields is a "Login" button. At the bottom, there is a "Security Warning" message: "Security Warning: You are logging in without encryption which is not recommended. To login securely [click here](#)." and a copyright notice: "Copyright © 2000- 2018 DrayTek Corp. All Rights Reserved."



Info

Even the password is changed, the Username for logging onto the web user interface is still "admin".

I-5 Dashboard

Dashboard shows the connection status including System Information, IPv4 Internet Access, IPv6 Internet Access, Interface (physical connection), Security and Quick Access.

Click Dashboard from the main menu on the left side of the main page.

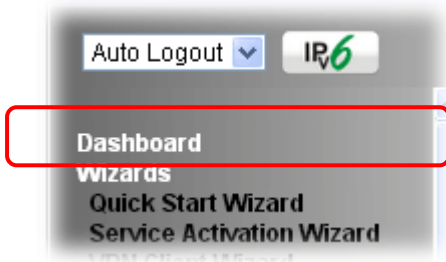

A web page with default selections will be displayed on the screen. Refer to the following figure:

Dashboard



The dashboard displays the following information:

System Information			
Model Name	VigorLTE200n	System Up Time	0:1:4
Router Name	DrayTek	Current Time	2000 Jan 1 Sat 0:0:57
Firmware Version	3.8.11	Build Date/Time	Apr 17 2019 19:00:48
LAN MAC Address	00-1D-AA-93-AE-94		

IPv4 LAN Information			
	IP Address	DHCP	
LAN1	192.168.1.1/24	v	LAN2
IP Routed Subnet	192.168.0.1/24	v	

IPv4 Internet Access				
	Line / Mode	IP Address	MAC Address	Up Time
LTE	USB / ---	Disconnected	00-1D-AA-93-AE-97	00:00:00
WAN2	Ethernet / ---	Disconnected	00-1D-AA-93-AE-96	00:00:00

IPv6 Internet Access				
	Mode	Address	Scope	Up Time
LAN	RADVD / DHCPv6	FE80::21D:AFF:FE93:AE94/64	Link	

Interface	
WAN	Connected : 0, LTE WAN2
LAN	Connected : 0, Port1 Port2
WLAN	Connected : 0

Security	
VPN	Connected : 0 Remote Dial-in User / LAN to LAN

System Resource	
CPU Usage:	1%

LTE Status	
Status	LTE access mode[None]
Bridge mode	Disabled
Access Tech	---
Band	---
Operator	---
Signal	RSSI: ---
New SMS	---

Quick Access	
System Status	
Dynamic DNS	
TR_069	
IM/P2P Block	
Schedule	
SysLog / Mail Alert	
RADIUS	
Firewall Object Setting	
Data Flow Monitor	

I-5-1 Virtual Panel

On the top of the Dashboard, a virtual panel (simulating the physical panel of the router) displays the physical interface connection. It will be refreshed every five seconds. When you move and click the mouse cursor on LEDs (except ACT), USB ports, or LAN1 - LAN4, related web setting page will be open for you to configure if required.



Port	Color	Description
LED	Black	It means the router or the function is not working.
	Green	It means the router or the function is working.

For detailed information about the LED display, refer to I-1-1 LED Indicators and Connectors.

I-5-2 Name with a Link

A name with a link (e.g., [Router Name](#), [Current Time](#), [LTE](#) and etc.) below means you can click it to open the configuration page for modification.

System Information			
Model Name	VigorLTE200n	System Up Time	0:1:4
Router Name	DrayTek	Current Time	2000 Jan 1 Sat 0:0:57
Firmware Version	3.8.11	Build Date/Time	Apr 17 2019 19:00:48
LAN MAC Address	00-1D-AA-93-AE-94		

IPv4 LAN Information					
	IP Address	DHCP		IP Address	DHCP
LAN1	192.168.1.1/24	v	LAN2	192.168.2.1/24	v
IP Routed Subnet	192.168.0.1/24	v			

IPv4 Internet Access				
	Line / Mode	IP Address	MAC Address	Up Time
LTE	USE / ---	Disconnected	00-1D-AA-93-AE-97	00:00:00
WAN2	Ethernet / ---	Disconnected	00-1D-AA-93-AE-96	00:00:00

IPv6 Internet Access				
	Mode	Address	Scope	Up Time
LAN	RADVD / DHCPv6	FE80::21D:AFF:FE93:AE94/64	Link	

Interface	
WAN	Connected : 0, <input type="radio"/> LTE <input type="radio"/> WAN2
<input type="checkbox"/> LAN	Connected : 0, <input checked="" type="radio"/> Port1 <input type="radio"/> Port2
<input type="checkbox"/> WLAN	Connected : 0

Security	
<input type="checkbox"/> VPN	Connected : 0 Remote Dial-in User / LAN to LAN

I-5-3 Quick Access for Common Used Menu

All the menu items can be accessed and arranged orderly on the left side of the main page for your request. However, some **important** and **common** used menu items which can be accessed in a quick way just for convenience.

Look at the right side of the Dashboard. You will find a group of common used functions grouped under **Quick Access**.

Quick Access
System Status
Dynamic DNS
TR-069
IM/P2P Block
Schedule
SysLog / Mail Alert
RADIUS
Firewall Object Setting
Data Flow Monitor

The function links of System Status, Dynamic DDNS, TR-069, IM/P2P Block, Schedule, Syslog/Mail Alert, RADIUS, Firewall Object Setting and Data Flow Monitor are displayed here. Move your mouse cursor on any one of the links and click on it. The corresponding setting page will be open immediately.

In addition, quick access for VPN security settings such as **Remote Dial-in User** and **LAN to LAN** are located on the bottom of this page. Scroll down the page to find them and use them if required.

Interface	
WAN	Connected : 0, <input type="radio"/> LTE <input type="radio"/> WAN2
LAN	Connected : 0, <input checked="" type="radio"/> Port1 <input type="radio"/> Port2
<input checked="" type="checkbox"/> WLAN	Connected : 0

Security	
<input checked="" type="checkbox"/> VPN	Connected : 0 Remote Dial-in User / LAN to LAN

System Resource	
Current Status :	CPU Usage: <input type="text" value="1%"/> 1%
	Memory Usage: <input type="text" value="68%"/> 68%

Note that there is a plus () icon located on the left side of LAN/WLAN. Click it to review the LAN/WLAN connection(s) used presently.

Host connected physically to the router via LAN port(s) will be displayed with green circles in the field of Connected.

All of the hosts (including wireless clients) displayed with Host ID, IP Address and MAC address indicates that the traffic would be transmitted through LAN port(s) and then the WAN port. The purpose is to perform the traffic monitor of the host(s).

I-5-4 GUI Map



All the functions the router supports are listed with table clearly in this page. Users can click the function link to access into the setting page of the function for detailed configuration. Click the icon on the top of the main screen to display all the functions.

GUI Map

Wizards	Quick Start Wizard Service Activation Wizard VPN Client Wizard VPN Server Wizard	LTE	General Settings SMS Inbox Send SMS Router Commands Status
Online Status	Physical Connection Virtual WAN	Wireless LAN	General Setup Security Access Control WPS WDS Advanced Setting AP Discovery Station List
WAN	General Setup Internet Access Multi-PVC/LAN	SSL VPN	User Account SSL Portal Online User
LAN	General Setup VLAN Bind IP to MAC	System Maintenance	System Status TR-069 Administrator Password User Password Configuration Backup
Routing	Static Route		
NAT	Port Redirection DMZ Host Open Ports ALG		

I-5-5 Web Console



It is not necessary to use the telnet command via DOS prompt. The changes made by using web console have the same effects as modified through web user interface. The functions/settings modified under Web Console also can be reviewed on the web user interface.

Click the **Web Console** icon on the top of the main screen to open the following screen.

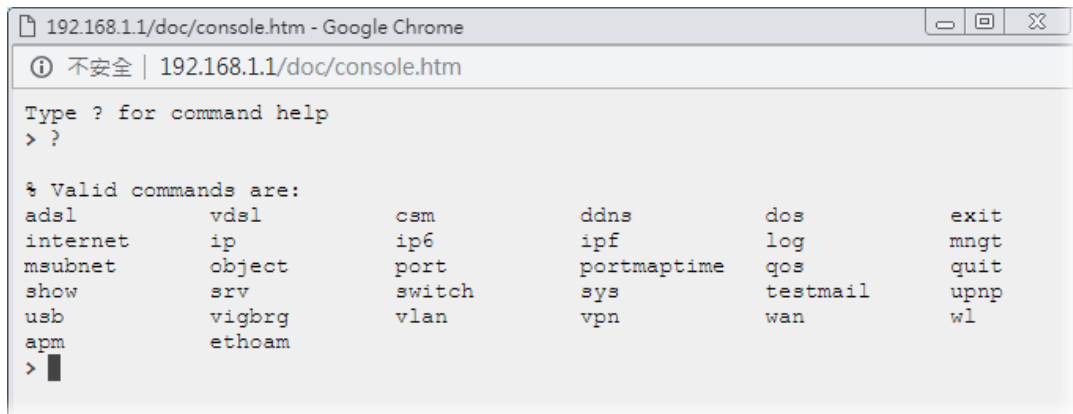

I-5-6 Config Backup



There is one way to store current used settings quickly by clicking the **Config Backup** icon. It allows you to backup current settings as a file. Such configuration file can be restored by using **System Maintenance>>Configuration Backup**.

Simply click the icon on the top of the main screen and a pop up dialog will appear.

Click **Save** to store the setting.

I-5-7 Logout



Click this icon to exit the web user interface.

I-5-8 Online Status



I-5-8-1 Physical Connection

Such page displays the physical connection status such as LAN connection status, WAN connection status, ADSL information, and so on.

Physical Connection for IPv4 Protocol

Online Status

Physical Connection		System Uptime: 0day 0:43:57			
IPv4		IPv6			
LAN Status					
IP Address	TX Packets	RX Packets	Router Primary DNS:	Router Secondary DNS:	
192.168.1.1	5,875	6,805	8.8.8.8	8.8.4.4	
LTE Status					
Enable	Line	Name	Mode	Up Time	Signal
Yes	USB		---	00:00:00	-
IP	GW IP	TX Packets	TX Rate(bps)	RX Packets	RX Rate(bps)
---	---	0	0	0	0
WAN 2 Status					
Enable	Line	Name	Mode	Up Time	
No	Ethernet		---	00:00:00	
IP	GW IP	TX Packets	TX Rate(bps)	RX Packets	RX Rate(bps)
---	---	0	0	0	0

Physical Connection for IPv6 Protocol

Online Status

Physical Connection		System Uptime: 0day 0:44:33	
IPv4	IPv6		
LAN Status			
IP Address FE80::21D:AAFF:FE93:AE94/64 (Link)			
TX Packets	RX Packets	TX Bytes	RX Bytes
17	907	1,334	76,460
LTE IPv6 Status			
Enable	Mode	Up Time	
No	Offline	---	
IP			Gateway IP
---			---
WAN2 IPv6 Status			
Enable	Mode	Up Time	
No	Offline	---	
IP			Gateway IP
---			---

Detailed explanation (for IPv4) is shown below:

Item	Description
LAN Status	<p>IP Address-Displays the IP address of the LAN interface.</p> <p>TX Packets-Displays the total transmitted packets at the LAN interface.</p> <p>RX Packets-Displays the total received packets at the LAN interface.</p>
LTE Status / WAN2 Status	<p>Enable - Yes in red means such interface is available but not enabled. Yes in green means such interface is enabled.</p> <p>Line - Displays the physical connection of this interface.</p> <p>Name - Display the name of the router.</p> <p>Mode - Displays the type of WAN connection (e.g., PPPoE).</p> <p>Up Time - Displays the total uptime of the interface.</p> <p>IP - Displays the IP address of the WAN interface.</p> <p>GW IP - Displays the IP address of the default gateway.</p> <p>TX Packets - Displays the total transmitted packets at the WAN interface.</p> <p>TX Rate - Displays the speed of transmitted octets at the WAN interface.</p> <p>RX Packets - Displays the total number of received packets at the WAN interface.</p> <p>RX Rate - Displays the speed of received octets at the WAN interface.</p>

Detailed explanation (for IPv6) is shown below:

Item	Description
LAN Status	<p>IP Address- Displays the IPv6 address of the LAN interface..</p> <p>TX Packets-Displays the total transmitted packets at the LAN interface.</p> <p>RX Packets-Displays the total received packets at the LAN</p>

Item	Description
	interface. TX Bytes - Displays the speed of transmitted octets at the LAN interface. RX Bytes - Displays the speed of received octets at the LAN interface.
LTE / WAN IPv6 Status	Enable - No in red means such interface is available but not enabled. Yes in green means such interface is enabled. No in red means such interface is not available. Mode - Displays the type of WAN connection (e.g., TSPC). Up Time - Displays the total uptime of the interface. IP - Displays the IP address of the WAN interface. Gateway IP - Displays the IP address of the default gateway.



Info

The words in green mean that the WAN connection of that interface is ready for accessing Internet; the words in red mean that the WAN connection of that interface is not ready for accessing Internet.

I-5-8-2 Virtual WAN

Such page displays the virtual WAN connection information.

Virtual WAN are used by TR-069 management, and so on.

The field of Application will list the purpose of such WAN connection.

I-6 Quick Start Wizard

Quick Start Wizard can help you to deploy and use the router easily and quickly. Go to **Wizards>>Quick Start Wizard**. The first screen of **Quick Start Wizard** is entering login password. After typing the password, please click **Next**.

Quick Start Wizard

Enter login password

Please enter an alpha-numeric string as your **Password**.

Old Password	<input type="text"/>
New Password	<input type="text" value="Max 23 characters"/>
Confirm Password	<input type="text"/>

Hint: If you want to keep the password unchanged, leave the password blank and press "Next" button to skip this process.

On the next page, please select the WAN interface that you use. If WAN interface is used, please choose WAN1; if USB interface is used, please choose LTE. Then click **Next** for next step. WAN2 and LTE will bring up different configuration page. Here, we take LTE as an example.

Quick Start Wizard

WAN Interface

WAN Interface:	<input type="text" value="LTE"/>
Display Name:	<input type="text"/>
Physical Mode:	USB

I-6-1 LTE

1. Choose LTE. Enter a string as Display Name (optional). Click Next.

Quick Start Wizard

WAN Interface

WAN Interface:	LTE ▾
Display Name:	<input type="text"/>
Physical Mode:	USB

2. After clicking Next, you will get the following web page.

Quick Start Wizard

Connect to Internet

LTE	
Internet Access :	3G/4G LTE Modem(DHCP mode) ▾
3G/4G LTE Modem(DHCP mode)	
SIM PIN code	<input type="text"/>
Network Mode	4G/3G ▾ (Default:4G/3G)
APN Name	<input type="text"/>

Available settings are explained as follows:

Item	Description
Internet Access	Specify a connection mode from the drop down menu.
SIM PIN code	Enter PIN code of the SIM card that will be used to access Internet.
Network Mode	Force Vigor router to connect Internet with the mode specified here. If you choose 4G/3G/2G as network mode, the router will choose a suitable one according to the actual wireless signal automatically.
APN Name	APN means Access Point Name which is provided and

Item	Description
	required by some ISPs.
Back	Click it to return to previous setting page.
Next	Click it to get into the next setting page.
Cancel	Click it to give up the quick start wizard.

3. Please manually enter the Username/Password provided by your ISP. Click **Next** for viewing summary of such connection.

Quick Start Wizard

Please confirm your settings:

WAN Interface:	LTE
Physical Mode:	USB
Internet Access:	DHCP
<p>Click Back to modify changes if necessary. Otherwise, click Finish to save the current settings and restart the Vigor router.</p>	

4. Click **Finish**. A page of **Quick Start Wizard Setup OK!!!** will appear.

Quick Start Wizard Setup OK!

5. Now, you can enjoy surfing on the Internet.

I-6-2 WAN2 (Ethernet)

WAN2 can be configured for physical mode of Ethernet. If you choose Ethernet WAN2, please specify a physical type. Then, click **Next**.

Quick Start Wizard

WAN Interface

WAN Interface:	WAN2 ▾
Display Name:	<input type="text"/>
Physical Mode:	Ethernet
Physical Type:	Auto negotiation ▾

< Back Next > Finish Cancel

Available settings are explained as follows:

Item	Description
Display Name	Type a name for the router.
Physical Mode	Display the physical mode of this WAN interface.
Physical Type	This setting is available when Ethernet is selected as Physical Mode . In general, Auto negotiation is suggested.

PPPoE

1. Choose **WAN2** as the WAN Interface and choose **Ethernet** as the **Physical Mode**. Click the **Next** button. The following page will be open for you to specify Internet Access Type.

Quick Start Wizard

Connect to Internet

WAN 2
Select one of the following Internet Access types provided by your ISP.

- PPPoE
- PPTP
- Static IP
- DHCP

< Back Next > Finish Cancel

- Click PPPoE as the Internet Access Type. Then click **Next** to get the following page.

Quick Start Wizard

PPPoE Client Mode

WAN 2
Enter the user name and password provided by your ISP.

Service Name (Optional)

Username

Password

Confirm Password

Available settings are explained as follows:

Item	Description
Service Name (Optional)	Enter the description of the specific network service.
Username	Assign a specific valid user name provided by the ISP. Note: The maximum length of the user name you can set is 63 characters.
Password	Assign a valid password provided by the ISP. Note: The maximum length of the password you can set is 62 characters.
Confirm Password	ReEnter the password.
Back	Click it to return to previous setting page.
Next	Click it to get into the next setting page.
Cancel	Click it to give up the quick start wizard.

3. Please manually enter the Username/Password provided by your ISP. Click **Next** for viewing summary of such connection.

Quick Start Wizard

Please confirm your settings:

WAN Interface:	WAN2
Physical Mode:	Ethernet
Physical Type:	Auto negotiation
Internet Access:	PPPoE

Click **Back** to modify changes if necessary. Otherwise, click **Finish** to save the current settings and restart the Vigor router.

4. Click **Finish**. A page of **Quick Start Wizard Setup OK!!!** will appear.

Quick Start Wizard Setup OK!

5. Now, you can enjoy surfing on the Internet.

PPTP

1. Choose PPTP as the WAN Interface and click the Next button.

Quick Start Wizard

Connect to Internet

WAN 2
Select one of the following Internet Access types provided by your ISP.

PPPoE
 PPTP
 Static IP
 DHCP

< Back Next > Finish Cancel

2. The following page will be open for you to Enter all the information originally provided by your ISP.

Quick Start Wizard

PPTP Client Mode

WAN 2
Enter the username, password, WAN IP configuration and PPTP server IP provided by your ISP.

Username
Password
Confirm Password

WAN IP Configuration
 Obtain an IP address automatically
 Specify an IP address

IP Address
Subnet Mask
Gateway
Primary DNS
Second DNS
PPTP Server

< Back Next > Finish Cancel

Available settings are explained as follows:

Item	Description
Username	Assign a specific valid user name provided by the ISP. Note: The maximum length of the user name you can set is 63 characters.
Password	Assign a valid password provided by the ISP. Note: The maximum length of the password you can set is 62 characters.
Confirm Password	ReEnter the password.

WAN IP Configuration	<p>Obtain an IP address automatically - the router will get an IP address automatically from DHCP server.</p> <p>Specify an IP address - you have to type relational settings manually.</p> <p>IP Address - Enter the IP address.</p> <p>Subnet Mask -Enter the subnet mask.</p> <p>Gateway - Enter the IP address of the gateway.</p> <p>Primary DNS - Enter the primary IP address for the router.</p> <p>Secondary DNS - Enter the secondary IP address for necessity in the future.</p>
PPTP Server	Enter the IP address of the server.
Back	Click it to return to previous setting page.
Next	Click it to get into the next setting page.
Cancel	Click it to give up the quick start wizard.

3. Please Enter the IP address/mask/gateway information originally provided by your ISP. Then click **Next** for viewing summary of such connection.

Quick Start Wizard

Please confirm your settings:

WAN Interface:	WAN2
Physical Mode:	Ethernet
Physical Type:	Auto negotiation
Internet Access:	PPTP

Click **Back** to modify changes if necessary. Otherwise, click **Finish** to save the current settings and restart the Vigor router.

4. Click **Finish**. A page of **Quick Start Wizard Setup OK!!!** will appear. Then, the system status of this protocol will be shown.

Quick Start Wizard Setup OK!

5. Now, you can enjoy surfing on the Internet.

Static IP

1. Click **Static IP** as the Internet Access type and click the **Next** button.

Quick Start Wizard

Connect to Internet

WAN 2
Select one of the following Internet Access types provided by your ISP.

PPPoE
 PPTP
 Static IP
 DHCP

< Back Next > Finish Cancel

2. The following page will be open for you to Enter the IP address information originally provided by your ISP.

Quick Start Wizard

Static IP Client Mode

WAN 2
Enter the Static IP configuration provided by your ISP.

WAN IP 192.168.3.100
Subnet Mask 255.255.255.0
Gateway 192.168.3.1
Primary DNS 8.8.8.8
Secondary DNS 8.8.4.4 (optional)

< Back Next > Finish Cancel

Available settings are explained as follows:

Item	Description
WAN IP	Enter the IP address.
Subnet Mask	Enter the subnet mask.
Gateway	Enter the IP address of gateway.
Primary DNS	Enter the primary IP address for the router.
Secondary DNS	Enter secondary IP address for necessity in the future.
Back	Click it to return to previous setting page.
Next	Click it to get into the next setting page.
Cancel	Click it to give up the quick start wizard.

3. Click **Next** for next step.

Quick Start Wizard

Please confirm your settings:

WAN Interface:	WAN1
Physical Mode:	Ethernet
Physical Type:	Auto negotiation
Internet Access:	Static IP

Click **Back** to modify changes if necessary. Otherwise, click **Finish** to save the current settings and restart the Vigor router.

4. Click **Finish**. A page of **Quick Start Wizard Setup OK!!!** will appear.

Quick Start Wizard Setup OK!

5. Now, you can enjoy surfing on the Internet.

DHCP

1. Click DHCP as the Internet Access type and click the Next button.

Quick Start Wizard

Connect to Internet

WAN 2
Select one of the following Internet Access types provided by your ISP.

PPPoE
 PPTP
 Static IP
 DHCP

< Back Next > Finish Cancel

2. The following page will be open for you to Enter the IP address information originally provided by your ISP.

Quick Start Wizard

DHCP Client Mode

WAN 2
If your ISP requires you to enter a specific host name or specific MAC address, please enter it in.

Host Name (optional)
MAC 00 - 1D - AA - A8 - B7 - 6A (optional)

< Back Next > Finish Cancel

Available settings are explained as follows:

Item	Description
Host Name	Enter the name of the host. Note: The maximum length of the host name you can set is 39 characters.
MAC	Some Cable service providers specify a specific MAC address for access authentication. In such cases you need to enter the MAC address.
Back	Click it to return to previous setting page.
Next	Click it to get into the next setting page.
Cancel	Click it to give up the quick start wizard.

3. After finished the settings above, click **Next** for viewing summary of such connection.

Quick Start Wizard

Please confirm your settings:

WAN Interface:	WAN2
Physical Mode:	Ethernet
Physical Type:	Auto negotiation
Internet Access:	DHCP

Click **Back** to modify changes if necessary. Otherwise, click **Finish** to save the current settings and restart the Vigor router.

4. Click **Finish**. A page of **Quick Start Wizard Setup OK!!!** will appear. Then, the system status of this protocol will be shown.

Quick Start Wizard Setup OK!

5. Now, you can enjoy surfing on the Internet.

I-7 Service Activation Wizard

Service Activation Wizard can guide you to activate WCF service (Web Content Filter) with a quick and easy way. For the Service Activation Wizard is only available for admin operation, please type "admin/admin" on Username/Password while Logging into the web user interface.

Service Activation Wizard is a tool which allows you to activate services without accessing into the server (**MyVigor**) located on <http://myvigor.draytek.com>.



Info

Such function is available only for Admin Mode.

1. Open Wizards>>Service Activation Wizard.

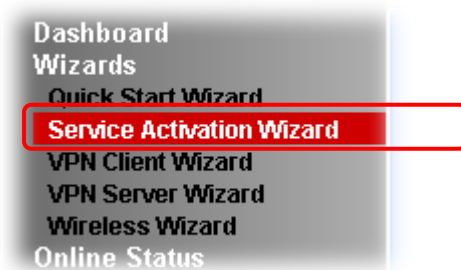

2. In the following page, you can activate the Web content filter services and DNS service at the same time or individually. When you finish the selection, please click Next.

Service Activation Wizard

Select the service type that you want to activate

Activation Date : 2019-02-25

Web Content Filter(WCF) Service :

BPJM [License Agreement](#)
This is a web content filter that is provided by the German government. It is a free service without any guarantee and will expire one year after activation. You may re-activate the service after expiry.

Cyren 30-Days Free Trial [License Agreement](#)
This is a worldwide web content filter service. The free trail license can only be used once. At the end of the free trail period you may purchase the official one-year Cyren Web Content Filter from an authorized DrayTek reseller.

Dynamic DNS(DDNS) Service :

DT-DDNS [License Agreement](#)
This is a Dynamic Domain Name Service that is provided by DrayTek company. It is a free service will expire 1 year after activation.
You may re-activate the service after expiry.

Domain Name : 2017101210301001 .draydns.com

I have read and accept the above Agreement. (Please check this box).

Next >

Cancel



Info

BPJM is web content filter (WCF) for German Speaking users. It is ideal for your family to provide more Internet security for youngsters.

Cryan 30-day trial is WCF which offers 30-day trial period. After trial, you can purchase DrayTek's prepared Cryan GlobalView WCF package from retailing outlets.

DT-DDNS, developed by DrayTek, offers one year free charge service of dynamic DNS service for internal use.

3. Setting confirmation page will be displayed as follows, please click **Activate**.

Service Activation Wizard

Please confirm your settings

Service Type : Trial version

Service Activated : Web Content Filter (Cyren / Commtouch)
Dynamic DNS (2017101210301001.drayddns.com)

Please click **Back** to re-select service type you to activate.

< Back **Activate** Cancel



Info

The service will be activated and applied as the default rule configured in Firewall>>General Setup.

4. Now, the web page will display the service that you have activated according to your selection(s). The valid time for the free trial of these services is one month.

Service Activation Wizard

Please confirm your settings

DrayTek Service Activation

Service Name	Start Date	Expire Date	Status
Web Content filter	2019-02-25	2019-03-25	Cyren
DDNS	2019-02-25	2019-03-25	DT-DDNS

Please check if the license fits with the service provider of your signature. To ensure normal operation for your router, update your signature again is recommended.

Copyright © DrayTek Corp. All Rights Reserved.

< Back Activate Cancel

I-8 Registering Vigor Router

You have finished the configuration of Quick Start Wizard and you can surf the Internet at any time. Now it is the time to register your Vigor router to MyVigor website for getting more service. Please follow the steps below to finish the router registration.

- 1 Please login the web configuration interface of Vigor router by typing "admin/admin" as User Name / Password.



The image shows the login page for the DrayTek VigorLTE 200 Series. It features a red header with the DrayTek logo and "VigorLTE 200 Series". Below the header is a "Login" section with two input fields: "Username" and "Password". A "Login" button is positioned below the password field. A security warning message is displayed below the button, stating: "Security Warning: You are logging in without encryption which is not recommended. To login securely [click here](#)." At the bottom, there is a copyright notice: "Copyright © 2000- 2018 DrayTek Corp. All Rights Reserved."

- 2 Click Support Area>>Production Registration from the home page.



The image shows a button labeled "Support Area" with a sub-label "Product Registration" below it. The button has a dark background and white text.

- 3 A Login page will be shown on the screen. Please Enter the account and password that you created previously. And click Login.

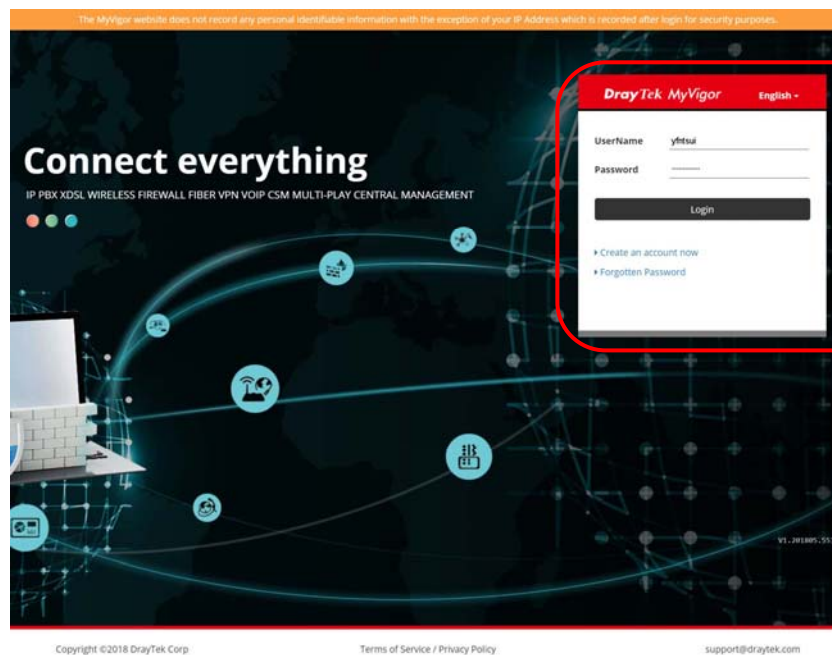

The image shows the DrayTek MyVigor website login page. The page has a dark background with a network diagram. The main heading is "Connect everything" with the sub-heading "IP PBX XDSL WIRELESS FIREWALL FIBER VPN VOIP CSM MULTI-PLAY CENTRAL MANAGEMENT". A login form is highlighted with a red border, containing the following fields: "Username" (with the value "yhtsui"), "Password", and a "Login" button. Below the button are links for "Create an account now" and "Forgotten Password". At the top right of the form, there is a language selector set to "English". At the bottom of the page, there is a copyright notice: "Copyright ©2018 DrayTek Corp", a link for "Terms of Service / Privacy Policy", and an email address: "support@draytek.com".



Info

If you haven't an accessing account, please refer to section Creating an Account for MyVigor to create your own one. Please read the articles on the Agreement regarding user rights carefully while creating a user account.

- The following page will be displayed after you logging in MyVigor. Type a nickname for the router, then click **Add**.

The screenshot shows the 'My Information - My Products' page in the MyVigor interface. A registration form is highlighted with a red border, containing the following fields: Nickname (VigorLTE 200), Registration Date (25-02-2019), and Serial number (2019022510301001). An 'Add' button is located to the right of the serial number field. To the right of the form, the last login time is 2017-06-29 16:24:01 and the last login from IP is 220.128.230.121. Below the form is a table with the following data:

Serial Number / Host ID	Device Name	Model	Note
2017062914095401	Vigor2852	Vigor2852	

- When the following page appears, your router information has been added to the database.

Your device has been successfully added to the database.



- After clicking OK, you will see the following page. Your router has been registered to myvigor website successfully.

The screenshot shows the 'Device Information' page in the MyVigor interface. The device name is VigorLTE 200, the serial number is 2019022510301001, and the model is VigorLTE 200. There are 'Rename', 'Transfer', and 'Back' buttons. Below this is a 'Device's Service' section with a table of services:

Service	Provider	Action	Status	Start Date	Expired Date	Note
WCF	BPJM	Activate	On	-	-	-
WCF	Cyren	Trial	On	-	-	-
APPE	DT-DDNS	Activate	On	-	-	-

Below the table, there is a note: [After the trial period, contact your local DrayTek dealer/distributor for purchasing the formal edition of WCF service.](#)

Part II Connectivity



WAN

It means wide area network. Public IP will be used in WAN.



LAN

It means local area network. Private IP will be used in LAN. Local Area Network (LAN) is a group of subnets regulated and ruled by router. The design of network structure is related to what type of public IP addresses coming from your ISP.



NAT

When the data flow passing through, the Network Address Translation (NAT) function of the router will dedicate to translate public/private addresses, and the packets will be delivered to the correct host PC in the local area network.



Applications

DNS, LAN DNS, IGMP, UPnP, WOL, RADIUS, SMS.



Routing

Static Route

II-1 LTE

LTE WAN with SIM card can provide convenient Internet access for Vigor router. However, we can't stop thinking about what can Vigor router utilize this SIM card to provide more useful functions for user? Now, we have developed some useful functions for user, such as sending SMS from a router to report router status, rebooting router remotely via SMS with taking security into consideration, and so on.

This section can guide you to use the SIM card in LTE WAN to perform SMS related operations.

Service Network

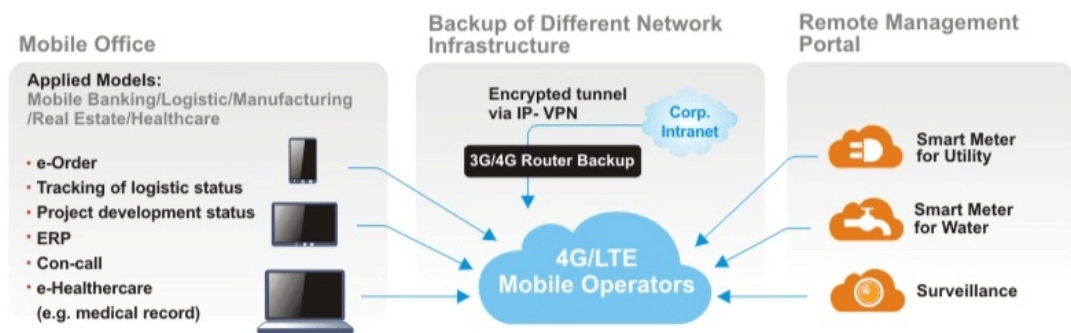

Web User Interface

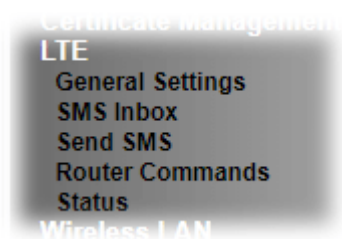

II-1-1 General Settings

This page allows you to configure general settings for LTE. When SMS Quota Limit is enabled, you can specify the number of SMS quota, actions to perform when quota exceeded, and the period of resetting SMS quota used.

II-1-1-1 SMS Quota

LTE >> General Settings

SMS Quota	SMS Inbox Policy
<input type="checkbox"/> Enable SMS Quota Limit Criterion and Action	
Quota Limit:	<input type="text" value="0"/> SMS (Current number of SMS sent: 0)
When quota exceeded :	<input type="checkbox"/> Stop sending SMS function <input type="checkbox"/> Send Mail Alert to Administrator
<input type="button" value="Monthly"/> <input type="button" value="Custom"/>	
Select the day of a month when your (cellular) data resets. SMS quota resets on day <input type="text" value="1"/> at <input type="text" value="00:00"/>	

- Note :**
1. Please make sure the **Time and Date** of the router is configured.
 2. When quota exceeded, user can choose to stop sending sms or send **e-mail** to administrator.
 3. After clicking OK, the counter used will be reset.

Available settings are explained as follows:

Item	Description
Enable SMS Quota Limit	Check the box to enable such feature.
Quota Limit	Specify the maximum number of sending SMS for LTE.
When quota exceeded	There are two actions to be performed when the quota limit is expired. Stop sending SMS - If it is checked, no SMS for LTE will be sent after the quota limit is expired. Send Mail Alert to Administrator - If it is checked, a mail alert will be sent to the administrator when the quota limit is expired.
Monthly	This setting is to offer a mechanism of resetting the number of SMS sent record every month. SMS quota resets on day XX at XX ... -You can determine the starting day in one month. The number of SMS sent will be

	reset.
Custom	<p>This setting allows the user to define the billing cycle according to his request.</p> <p>The number of SMS sent will be reset with an interval of cycle duration.</p> <p>Custom - Monthly is default setting. If long period or a short period is required, use Custom. The period of reset is between 1 day and 60 days. You can determine the cycle duration by specifying the days and the hours.</p> <ul style="list-style-type: none"> ● Cycle duration: Specify the days to reset the number of SMS sent. For example, 7 means the whole cycle is 7 days; 20 means the whole cycle is 20 days. When the time is up, the router will reset the number of SMS sent automatically. ● Today is day XX in the cycle -Specify the day in the cycle duration as the starting point which Vigor router will reset the number of SMS sent. For example, 3 means the third day of the duration cycle.

II-1-1-2 SMS Inbox Policy

Such page allows you to determine which policy shall be used for SMS inbox/outbox.

LTE >> General Settings

SMS Quota	SMS Inbox Policy
<p>SMS Inbox Policy</p> <p><input type="checkbox"/> If SMS inbox is full, send e-mail alert to Administrator</p> <p><input type="checkbox"/> If SMS inbox is full, delete the oldest read SMS</p> <p><input type="checkbox"/> Forward new SMS with e-mail to Administrator</p>	
<p>OK Cancel</p>	

II-1-2 SMS Inbox

This page will list the received SMS messages in the LTE SIM card. The SMS Inbox table shows the received date, the phone number or sender ID where this message was from, and the beginning of the message content.

Since the data size of one SMS is limited, a long message will be sent by multiple SMS. For the convenience of users, we provide two modes. **Simple Mode** lists SMS messages in order for received time. **Advanced Mode** lists SMS in order for real index in the SIM card. Different SIM cards have different capacities. In general, it's around 30 to 40 SMS. Please note that the SIM card can not receive new SMS when all SMS indexes are occupied.

Click the Simple Mode link or the Advanced Mode link below to switch between these two modes.

II-1-2-1 Simple Mode

LTE >> SMS Inbox

LTE SMS Inbox

Details	Mark as Read	Delete	Date	From	Message
View	<input type="checkbox"/>	<input type="checkbox"/>	2015/10/21 12:03:29	886911520000	
View	<input type="checkbox"/>	<input type="checkbox"/>	2015/10/21 11:31:59	+886905269930	22
View	<input type="checkbox"/>	<input type="checkbox"/>	2015/10/21 11:31:51	+886905269930	11
View	<input type="checkbox"/>	<input type="checkbox"/>	2015/10/21 09:29:39	+886905269930	1
View	<input type="checkbox"/>	<input type="checkbox"/>	2015/10/20 10:15:44	+886988126053	remote reboot 000000
View	<input type="checkbox"/>	<input type="checkbox"/>	2015/10/20 10:14:18	+886988126053	remote reboot 000000
View	<input type="checkbox"/>	<input type="checkbox"/>	2015/10/20 10:06:49	+886988126053	remote reboot iyt
View	<input type="checkbox"/>	<input type="checkbox"/>	2015/10/20 10:01:01	+886905269930	41
View	<input type="checkbox"/>	<input type="checkbox"/>	2015/10/16 14:13:29	+886988126053	
View	<input type="checkbox"/>	<input type="checkbox"/>	2015/10/16 14:12:46	+886988126053	

Simple Mode: Show SMS messages in order of received dates.

Advanced Mode: Show SMS in order of indexes in SIM card.

OK

Available settings are explained as follows:

Item	Description
Mark as Read	Those messages in "unread" state are showed in bold text. If you want to change messages into "read" state, select them and click the OK button. Checking the checkbox in title will select all "unread" messages in this page.
Delete	If you want to delete messages, select them and click the OK button. Checking the checkbox in title will select all messages in this page.
Details	If you want to read the full content of the message, click the View link of that message to open the following page. It will change the message into "read" state.

LTE >> SMS Inbox

Date: 2015/09/11 14:33:08
 From: + [Redacted]
 Message Content:
 123

- Message Content - Display the full content of the message.
- OK - Return to previous page.
- Delete - Click it to delete this message and return to previous page.
- Next - Click it to see the content of next message.

II-1-2-1 Advanced Mode

LTE >> SMS Inbox

LTE SMS Inbox

Index	Mark as Read <input type="checkbox"/>	Delete <input type="checkbox"/>	Date	From	Message
1.	<input type="checkbox"/>	<input type="checkbox"/>	2011/09/08 05:22:56	+ [Redacted]	[Redacted]
2.	<input type="checkbox"/>	<input type="checkbox"/>	2015/09/10 13:54:33	+ [Redacted]	[Redacted]
3.	<input type="checkbox"/>	<input type="checkbox"/>	2015/09/10 17:27:43	+ [Redacted]	router status 123
4.	<input type="checkbox"/>	<input type="checkbox"/>	2015/09/10 17:28:37	+ [Redacted]	[Redacted]
5.	<input type="checkbox"/>	<input type="checkbox"/>	2015/09/10 18:24:32	+ [Redacted]	router status 123
6.	<input type="checkbox"/>	<input type="checkbox"/>	2015/09/10 18:25:39	+ [Redacted]	[Redacted]
7.	<input type="checkbox"/>	<input type="checkbox"/>	2015/09/10 19:37:44	+ [Redacted]	router status 123
8.	<input type="checkbox"/>	<input type="checkbox"/>	2015/09/10 19:39:09	+ [Redacted]	1234567890
9.	<input type="checkbox"/>	<input type="checkbox"/>	2015/09/10 20:08:46	+ [Redacted]	%^@#0\$@#0\$%^* & () # ^ !

Available settings are explained as follows:

Item	Description
Mark as Read	Those SMS in "unread" state are shown in bold text. If you want to change SMS into "read" state, select them and click the OK button. Checking the checkbox in title will select all "unread" SMS in this page.
Delete	If you want to delete SMS, select them and click the OK button. Checking the checkbox in title will select all SMS in this page.
Index	If you want to read the full content of the message of the SMS, click the index link of that SMS to open the following page. It will change all SMS of the message into "read" state.

Index No.17

Date: 2015/09/11 14:33:08
From: + [REDACTED]
Message Content:

123

Message Content - Display the full content of the message.

OK - Return to previous page.

Delete - Click it to delete all SMS of this message and return to previous page.

Next - Click it to see the content of next SMS index.

II-1-3 Send SMS

This page is used to send SMS messages by the LTE SIM card. It also displays the number of SMS required to send the message.

LTE >> Send SMS

Send SMS Message

Recipient Number

Data Coding Scheme English Only (GSM 7-bit) ▾

0 / 160 characters (1 SMS)

Message

View [SMS Outbox Cache](#)

Available settings are explained as follows:

Item	Description																																								
Recipient Number	Type the phone number of the recipient. The format can be an international phone number (+886912345678) or a general phone number(0912345678).																																								
Data Coding Scheme	The router will automatically select a suitable Data Coding Scheme according to the current content in Message. GSM 7-bit and UCS-2 are supported.																																								
Message	Type in the message content to send. The total number of characters that you can type in this field is 1024.																																								
Send Message	Click it to send this SMS message to the recipient immediately.																																								
View SMS Outbox Cache	Display the record of SMS messages sent from the Router. <div style="border: 1px solid gray; padding: 5px; margin-top: 5px;"> <p>LTE >> SMS Outbox Cache</p> <hr/> <p>LTE SMS Outbox Cache</p> <table border="1" style="width: 100%; border-collapse: collapse;"> <thead> <tr> <th>Details</th> <th>Delete</th> <th>Date</th> <th>To</th> <th>Message</th> </tr> </thead> <tbody> <tr> <td>View</td> <td><input type="checkbox"/></td> <td>2015/10/05 03:12:06</td> <td>1234567890</td> <td>55555555555555555555</td> </tr> <tr> <td>View</td> <td><input type="checkbox"/></td> <td>2015/10/05 03:12:01</td> <td>1234567890</td> <td>44444444444444444444</td> </tr> <tr> <td>View</td> <td><input type="checkbox"/></td> <td>2015/10/05 03:11:56</td> <td>1234567890</td> <td>33333333333333333333</td> </tr> <tr> <td>View</td> <td><input type="checkbox"/></td> <td>2015/10/05 03:11:51</td> <td>1234567890</td> <td>2222222222222222</td> </tr> <tr> <td>View</td> <td><input type="checkbox"/></td> <td>2015/10/05 03:11:46</td> <td>1234567890</td> <td>111111</td> </tr> <tr> <td>View</td> <td><input type="checkbox"/></td> <td>2015/10/05 03:07:55</td> <td>1234567890</td> <td>居易科技於1997年成立，</td> </tr> <tr> <td>View</td> <td><input type="checkbox"/></td> <td>2015/10/05 03:04:38</td> <td>1234567890</td> <td>Test Test Nancy 123</td> </tr> </tbody> </table> <p><small>Note: Records in Outbox Cache are NOT preserved after replacement of newer records or Router reboot.</small></p> <p style="text-align: center;"><input type="button" value="OK"/></p> </div>	Details	Delete	Date	To	Message	View	<input type="checkbox"/>	2015/10/05 03:12:06	1234567890	55555555555555555555	View	<input type="checkbox"/>	2015/10/05 03:12:01	1234567890	44444444444444444444	View	<input type="checkbox"/>	2015/10/05 03:11:56	1234567890	33333333333333333333	View	<input type="checkbox"/>	2015/10/05 03:11:51	1234567890	2222222222222222	View	<input type="checkbox"/>	2015/10/05 03:11:46	1234567890	111111	View	<input type="checkbox"/>	2015/10/05 03:07:55	1234567890	居易科技於1997年成立，	View	<input type="checkbox"/>	2015/10/05 03:04:38	1234567890	Test Test Nancy 123
Details	Delete	Date	To	Message																																					
View	<input type="checkbox"/>	2015/10/05 03:12:06	1234567890	55555555555555555555																																					
View	<input type="checkbox"/>	2015/10/05 03:12:01	1234567890	44444444444444444444																																					
View	<input type="checkbox"/>	2015/10/05 03:11:56	1234567890	33333333333333333333																																					
View	<input type="checkbox"/>	2015/10/05 03:11:51	1234567890	2222222222222222																																					
View	<input type="checkbox"/>	2015/10/05 03:11:46	1234567890	111111																																					
View	<input type="checkbox"/>	2015/10/05 03:07:55	1234567890	居易科技於1997年成立，																																					
View	<input type="checkbox"/>	2015/10/05 03:04:38	1234567890	Test Test Nancy 123																																					

II-1-4 Router Commands

This page allows the user to set function to reboot Vigor router remotely and get the router status via SMS.

Get Router Status or Reboot Router via SMS Message

Get Router Status



Reboot Router



Go to LTE>>Router Commands to get the following page.

LTE >> Router Commands

Reboot on SMS Message

Enable with Password / PIN

Access Control List

List	Phone Number
1	<input type="text"/>
2	<input type="text"/>
3	<input type="text"/>

Note: To reboot the router via SMS, send a message starting with "remote reboot" to the router's phone number, followed by Password/PIN.

Reply with Router Status Message

Enable with Password / PIN

Access Control List

List	Phone Number
1	<input type="text"/>
2	<input type="text"/>
3	<input type="text"/>

Message Contents

Router Name Router Up-Time Firmware Version MAC Address

WAN1 IP WAN2 IP LTE IP

WAN1 Data Usage WAN2 Data Usage LTE Data Usage

SMS Number per Status Response : 0

Note: To get status information from the router, send a message starting with "router status" to the router's phone number, followed by the password / PIN if that is enabled.

Note: Phone numbers in the Access Control List should be in international format (e.g., +886123456789).

OK

Available settings are explained as follows:

Item	Description
Reboot on SMS Message	
Enable with Password / PIN	To reboot Vigor router remotely via SMS, please check such box and type the password/PIN number (treated as

	<p>authentication for any mobile phone).</p> <p>The password shall be composed by letters, numbers and baseline.</p>
Access Control List	<p>Check the box to type or modify (up to 3) phone numbers. The phone number specified here is capable of sending SMS to reboot such Vigor router remotely.</p> <p>Note: If such option is enabled, only mobile phones specified here are allowed to send SMS to reboot Vigor router if correct password is given. That is, if it is disabled (unchecked), any mobile phone can send SMS to reboot such Vigor router if correct password is given.</p>
Reply with Router Status Message	
Enable with Password / PIN	<p>Users can get the WAN data usage and basic information about Vigor router (e.g., IP address, MAC address) through the mobile phone by entering the password/PIN specified in this field.</p> <p>The password shall be composed by letters, numbers and baseline.</p>
Access Control List	<p>Check the box to type or modify (up to 3) phone numbers. The phone number specified here is capable of getting related information about Vigor router remotely.</p> <p>Note: If such option is enabled, only mobile phones specified here are allowed to obtaine related information about Vigor router if correct password is given. That is, if it is disabled (unchecked), any mobile phone can get the data of Vigor router if correct password is given.</p>
Message Contents	<p>There are several types of message contents for you to select. Choose and check the required item, then Vigor router will offer the status response about that item via SMS.</p>
SMS messages per status response	<p>Display the total number of the type for status response.</p> <p>Display the total number of SMS required to send the status message which contains the current selected Message Contents.</p>

II-1-5 Status

Vigor router with LTE function is capable of accessing into Internet and able to send SMS to specified mobile phone.

This page will display basic information about the embedded LTE module and the current LTE connection.

LTE >> Status

[Refresh](#)

LTE Modem	
Status:	Operational
IMEI:	356318040749422
IMSI:	466924200859808
ICCID:	---
Access Tech:	LTE
Band:	E-UTRA Op Band 3
Operator:	Chunghwa
Mobile Country Code:	466
Mobile Network Code:	92
Location Area Code:	65534
Cell ID:	81023501
RSSI Signal:	-61 dBm
Active Channel:	1725
Max Channel TX Rate:	50 Mbps
Max Channel RX Rate:	100 Mbps
LTE SMS	
SMS Centre Number:	+886932400821
SMS Service Status:	Ready
SMS Loading:	Ready
New SMS:	4

Each item is explained as follows:

Item	Description
Status	LTE WAN status.
IMEI	International Mobile Equipment Identity of the embedded LTE module.
IMSI	International Mobile Subscriber Identity of the LTE SIM card.
Access Tech	Type of LTE connection (CDMA/GSM/WCDMA/LTE/TD-SCDMA).
Band	Band of LTE connection.
Operator	ISP name of LTE connection.
Mobile Country Code / Mobile Network Code / Location Area Code / Cell ID :	Base station information.
RSSI Signal	Signal strength of LTE connection.
Active Channel	Frequency of LTE connection.
Max Channel TX Rate /	Maximum TX/RX link rate of LTE connection.

Max Channel RX Rate	
SMS Centre Number	The phone number for SMS service of the LTE SIM card.
SMS Service status	Whether the SMS service of the LTE SIM card is ready.
SMS Loading	Whether the received SMS messages in the LTE SIM card have been loaded to the Router.
New SMS	The number of unread SMS in SMS Inbox.

II-2 WAN

It allows users to access Internet.

Basics of Internet Protocol (IP) Network

IP means Internet Protocol. Every device in an IP-based Network including routers, print server, and host PCs, needs an IP address to identify its location on the network. To avoid address conflicts, IP addresses are publicly registered with the Network Information Centre (NIC). Having a unique IP address is mandatory for those devices participated in the public network but not in the private TCP/IP local area networks (LANs), such as host PCs under the management of a router since they do not need to be accessed by the public. Hence, the NIC has reserved certain addresses that will never be registered publicly. These are known as *private* IP addresses, and are listed in the following ranges:

From 10.0.0.0 to 10.255.255.255
From 172.16.0.0 to 172.31.255.255
From 192.168.0.0 to 192.168.255.255

What are Public IP Address and Private IP Address

As the router plays a role to manage and further protect its LAN, it interconnects groups of host PCs. Each of them has a private IP address assigned by the built-in DHCP server of the Vigor router. The router itself will also use the default **private IP** address: 192.168.1.1 to communicate with the local hosts. Meanwhile, Vigor router will communicate with other network devices through a **public IP** address. When the data flow passing through, the Network Address Translation (NAT) function of the router will dedicate to translate public/private addresses, and the packets will be delivered to the correct host PC in the local area network. Thus, all the host PCs can share a common Internet connection.

Get Your Public IP Address from ISP

In ADSL deployment, the PPP (Point to Point)-style authentication and authorization is required for bridging customer premises equipment (CPE). Point to Point Protocol over Ethernet (PPPoE) connects a network of hosts via an access device to a remote access concentrator or aggregation concentrator. This implementation provides users with significant ease of use. Meanwhile it provides access control, billing, and type of service according to user requirement.

When a router begins to connect to your ISP, a serial of discovery process will occur to ask for a connection. Then a session will be created. Your user ID and password is authenticated via **PAP** or **CHAP** with **RADIUS** authentication system. And your IP address, DNS server, and other related information will usually be assigned by your ISP.

Web User Interface

WAN
General Setup
Internet Access
Multi-PVC/VLAN
LAN

II-2-1 General Setup

This section will introduce some general settings of Internet and explain the connection modes for LTE/WAN in details.

WAN >> General Setup

Index	Enable	Physical Mode/Type	Active Mode
LTE	<input checked="" type="checkbox"/>	USB/-	Always On
WAN2	<input type="checkbox"/>	Ethernet/Auto negotiation	Failover

Note:

One WAN interface can be active at any one time. Setting either WAN interface to "Always On" will set the other interface to operate as the "Failover" WAN connection.

Available settings are explained as follows:

Item	Description
Index	Click the LTE/ WAN interface link under Index to access into the WAN configuration page.
Enable	V means such WAN interface is enabled and ready to be used.
Physical Mode / Type	Display the physical mode and physical type of such WAN interface.
Active Mode	Display whether such WAN interface is Active device or backup device.

II-2-1-1 LTE

To use LTE network connection through LTE module, please configure LTE interface.

WAN >> General Setup

LTE

Enable:	Yes ▾
Display Name:	<input type="text"/>
Physical Mode:	USB
Active Mode:	Always On ▾

OK Cancel

Available settings are explained as follows:

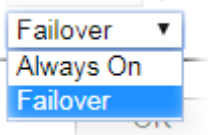
Item	Description
Enable	Choose Yes to invoke the settings for this WAN interface. Choose No to disable the settings for this WAN interface.
Display Name	Enter the description for such WAN interface.
Physical Mode	Display the physical mode of this WAN interface.
Active Mode	<p>In general, LTE WAN is main interface and is always on for Internet connection. However, if WAN2 is enabled and set as Always On, the LTE WAN can be treated as backup WAN and allowed to be set as Always On or Failover.</p>  <p>Always On - Make the LTE connection being activated always.</p> <p>Failover - Choose it to make the LTE connection as a backup connection.</p>

After finished the above settings, click OK to save the settings.

II-2-1-2 WAN2

Click WAN2 link to get the following page:

WAN >> General Setup

WAN 2

Enable:	Yes ▾
Display Name:	<input type="text"/>
Physical Mode:	Ethernet
Physical Type:	Auto negotiation ▾
VLAN Tag insertion :	Disable ▾ (Please configure Internet Access setting first)
Tag value:	<input type="text"/> (0~4095)
Priority:	<input type="text"/> (0~7)
Active Mode:	Failover ▾

OK Cancel

Available settings are explained as follows:

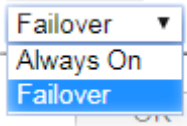
Item	Description
Enable	Choose Yes to invoke the settings for this WAN interface. Choose No to disable the settings for this WAN interface.
Display Name	Enter the description for such WAN interface.
Physical Mode	Display the physical mode of this WAN interface.
VLAN Tag insertion	<p>Enable - Enable the function of VLAN with tag. The router will add specific VLAN number to all packets on the WAN while sending them out. Please Enter the tag value and specify the priority for the packets sending by WAN interface.</p> <p>Disable - Disable the function of VLAN with tag.</p> <p>Tag value - Enter the value as the VLAN ID number. The range is from 0 to 4095.</p> <p>Priority - Enter the packet priority number for such VLAN. The range is from 0 to 7.</p>
Active Mode	<p>Choose Always On to make the WAN1 connection being activated always.</p>  <p>Failover - Choose it to make the WAN connection as a backup connection.</p>

After finished the above settings, click **OK** to save the settings.

II-2-2 Internet Access

This page allows you to set WAN configuration with different modes.

WAN >> Internet Access

Internet Access

Index	Display Name	Physical Mode	Access Mode		
LTE		USB	None	Details Page	IPv6
WAN2		Ethernet	None	Details Page	IPv6

DHCP Client Option

Available settings are explained as follows:

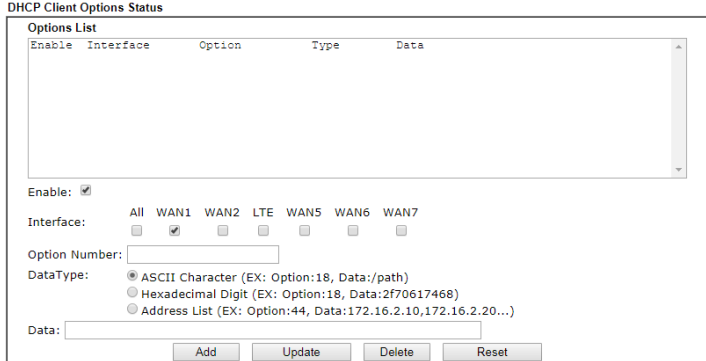
Item	Description
Index	Display the WAN interface.
Display Name	It shows the name of the WAN1/WAN2/LTE that entered in general setup.
Physical Mode	It shows the physical connection for WAN (Ethernet or fiber) according to the real network connection.
Access Mode	Use the drop down list to choose a proper access mode. The details page of that mode will be popped up. If not, click Details Page for accessing the page to configure the settings.
Details Page	This button will open different web page (based on IPv4) according to the access mode that you choose in WAN interface.
IPv6	This button will open different web page (based on Physical Mode) to setup IPv6 Internet Access Mode for WAN interface. If IPv6 service is active on this WAN interface, the color of "IPv6" will become green.
DHCP Client Option	<p>This button allows you to configure DHCP client options. DHCP packets can be processed by adding option number and data information when such function is enabled and configured.</p> <p>WAN >> Internet Access</p>  <p>Note:</p> <ol style="list-style-type: none"> Option 12 is reserved. You cannot configure it here, but you can configure it in "Router Name" field of "WAN >> Internet Access >> Details Page". Option 55 is reserved and configured with value 1, 3, 6, 15 and 212, also 33 and 121 for some models. Configuring option 61 here will override the setting in "WAN >> Internet Access" page's DHCP Client Identifier field. <p>OK</p>

	<p>Enable - Check the box to enable the function of DHCP Option. Each DHCP option is composed by an option number with data. For example,</p> <p style="padding-left: 20px;">Option number:100 Data: abcd</p> <p>When such function is enabled, the specified values for DHCP option will be seen in DHCP reply packets.</p> <p>Interface - Specify the WAN interface(s) that will be overwritten by such function. WAN5 ~ WAN6 can be located under WAN>>Multi-PVC/VLAN.</p> <p>Option Number - Type a number for such function.</p> <div style="border: 1px solid black; padding: 5px; margin: 5px 0;"> <p>Note: If you choose to configure option 61 here, the detailed settings in WAN>>Interface Access will be overwritten.</p> </div> <p>DataType - Choose the type (ASCII or Hex) for the data to be stored.</p> <p>Data - Enter the content of the data to be processed by the function of DHCP option.</p>
--	--

II-2-2-1 Details Page for 3G/4G LTE Modem (DHCP mode) in LTE WAN

LTE WAN uses the embedded LTE module to access internet.

To use 3G/4G LTE Modem (DHCP mode) as the accessing protocol of the internet, please choose **Internet Access** from WAN menu. Then, select **3G/4G LTE Modem (DHCP mode)** for LTE. The following web page will be shown.

WAN >> Internet Access

LTE

<p style="text-align: center;">3G/4G LTE Modem(DHCP mode) IPv6</p> <p><input type="radio"/> Enable <input checked="" type="radio"/> Disable</p> <hr/> <p>LTE hardware version ---</p> <p>WAN Connection Detection</p> <p>Mode <input type="text" value="ARP Detect"/> ▼</p> <hr/> <p>MTU <input type="text" value="1470"/> (Default:1470)</p> <p>Path MTU Discovery <input type="button" value="Choose IP"/></p>	<p>Preferred LTE Band</p> <p><input type="checkbox"/> Enable Bridge Mode (Use LAN Port P1)</p> <p><input type="checkbox"/> Bridge Specific MAC Address</p> <p style="text-align: center;"><input type="text" value="00"/> : <input type="text" value="00"/> : <input type="text" value="00"/> : <input type="text" value="00"/> : <input type="text" value="00"/> : <input type="text" value="00"/></p>
<p>SIM1 Settings</p> <p>SIM PIN code <input type="text"/></p> <p>Network Mode <input type="text" value="4G/3G"/> ▼ (Default:4G/3G)</p> <p>APN Name <input type="text"/></p> <hr/> <p>Keep WAN Connection</p> <p><input checked="" type="checkbox"/> Enable PING to keep alive (Timeout: 10 secs.)</p> <p> PING to the IP <input type="text" value="8.8.8.8"/></p> <p><input type="checkbox"/> Connection Latency Check</p> <p> Latency <input type="text" value="800"/> ms</p> <p> Latency Duration <input type="text" value="60"/> seconds</p> <hr/> <p>Authentication <input type="text" value="PAP or CHAP"/> ▼</p> <p>Username <input type="text"/> (Optional)</p> <p>Password <input type="text"/> (Optional)</p>	<p>SIM2 Settings</p> <p>SIM PIN code <input type="text"/></p> <p>Network Mode <input type="text" value="4G/3G"/> ▼ (Default:4G/3G)</p> <p>APN Name <input type="text"/></p> <hr/> <p>Keep WAN Connection</p> <p><input checked="" type="checkbox"/> Enable PING to keep alive (Timeout: 10 secs.)</p> <p> PING to the IP <input type="text" value="8.8.8.8"/></p> <hr/> <p>Authentication <input type="text" value="PAP or CHAP"/> ▼</p> <p>Username <input type="text"/> (Optional)</p> <p>Password <input type="text"/> (Optional)</p>

Note:

Preferred LTE band setting will take effect until next LTE connection.

Available settings are explained as follows:

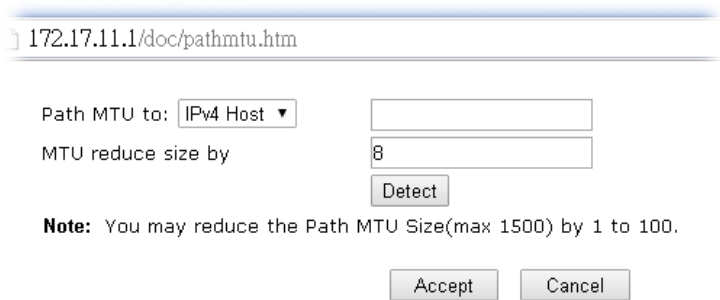
Item	Description
Enable	Click Enable for activating this function. If you click Disable , this function will be closed and all the settings that you adjusted in this page will be invalid.
LTE hardware version	The hardware version of the embedded LTE module.
WAN Connection Detection	<p>Such function allows you to verify whether network connection is alive or not through ARP Detect or Ping Detect.</p> <p>Mode - Choose ARP Detect or Ping Detect for the system to execute for WAN detection. If you choose Ping Detect as the detection mode, you have to type required settings for the following items.</p> <ul style="list-style-type: none"> ● Primary/Secondary Ping IP - If you choose Ping Detect as detection mode, you have to type Primary or Secondary IP address in this field for pinging. ● Ping Gateway IP - If you choose Ping Detect as detection mode, you also can enable this setting to use current WAN gateway IP address for pinging. With the IP address(es) pinging, Vigor router can check if the WAN connection is on or off. ● TTL (Time to Live) - Set TTL value of PING operation. ● Ping Interval - Type the interval for the system to execute the PING operation. ● Ping Retry - Type the number of times that the system is allowed to execute the PING operation before WAN disconnection is judged.
MTU	<p>It means Max Transmit Unit for packet.</p> <p>Path MTU Discovery - It is used to detect the maximum MTU size of a packet not to be segmented in specific transmit path.</p> <p>Click Choose IP to open the following dialog.</p>  <ul style="list-style-type: none"> ● Path MTU to - Type the IP address as the specific transmit path. ● MTU reduce size by - It determines the decreasing size of MTU value. For example, the number specified in this field is "8". The maximum MTU size is "1500". After clicking the "detect" button, the system will calculate and get the suitable MTU value such as 1500, 1492, 1484 and etc., automatically. ● Detect - Click it to detect a suitable MTU value. ● Accept - After clicking it, the detected value will be displayed in the field of MTU.

SIM1 Settings	
SIM PIN code	Type PIN code of the SIM card that will be used to access Internet. The maximum length of the PIN code you can set is 19 characters.
Network Mode	Force Vigor router to connect Internet with the mode specified here. If you choose 4G/3G/2G as network mode, the router will choose a suitable one according to the actual wireless signal automatically.
APN Name	APN means Access Point Name which is provided and required by some ISPs. Type the name and click Apply . The maximum length of the name you can set is 47 characters.
Keep WAN Connection	<p>Normally, this function is designed for Dynamic IP environments because some ISPs will drop connections if there is no traffic within certain periods of time. Check Enable PING to keep alive box to activate this function.</p> <p>Enable PING to Keep alive - If you enable the PING function, please specify an IP address for the system to PING it for keeping alive. Vigor system will send a packet per second to the specified IP address. If the system does not receive any reply from that IP within 10 seconds, Vigor system will reboot LTE module until successfully set LTE connection.</p> <ul style="list-style-type: none"> ● PING to the IP - Enter an IP address. <p>Connection Latency Check - Enable the latency time setting for packet reply. If it is enabled (checked), Vigor system will wait for the packet reply from the specified IP address. When the time of waiting packet reply reaches the time threshold (defined in Latency) and continues for a period of time (defined in Latency Duration), Vigor system will reboot LTE module until successfully set LTE connection.</p> <ul style="list-style-type: none"> ● Latency - Set a time threshold for packet reply. Default value is 800 (unit: micro-second). ● Latency Duration - Set a time period. Default value is 60 (unit: second). <p>Authentication - Select None or PAP or CHAP.</p> <p>UserName - Enter the username (optional). The maximum length of the name you can set is 47 characters.</p> <p>Password - Enter the password (optional). The maximum length of the password you can set is 62 characters.</p>
SIM2 Settings	
SIM PIN code	Type PIN code of the SIM card that will be used to access Internet. The maximum length of the PIN code you can set is 19 characters.
Network Mode	Force Vigor router to connect Internet with the mode specified here. If you choose 4G/3G/2G as network mode, the router will choose a suitable one according to the actual wireless signal automatically.
APN Name	APN means Access Point Name which is provided and required by some ISPs. Type the name and click Apply . The maximum length of the name you can set is 47

	characters.
Keep WAN Connection	<p>Normally, this function is designed for Dynamic IP environments because some ISPs will drop connections if there is no traffic within certain periods of time. Check Enable PING to keep alive box to activate this function.</p> <p>Enable PING to Keep alive - If you enable the PING function, please specify an IP address for the system to PING it for keeping alive. Vigor system will send a packet per second to the specified IP address. If the system does not receive any reply from that IP within 10 seconds, Vigor system will reboot LTE module until successfully set LTE connection.</p> <ul style="list-style-type: none"> ● PING to the IP - Enter an IP address. <p>Authentication - Select None or PAP or CHAP.</p> <p>UserName - Enter the username (optional). The maximum length of the name you can set is 47 characters.</p> <p>Password - Enter the password (optional). The maximum length of the password you can set is 62 characters.</p>
Preferred LTE Band	<p>Click the link to open a pop-up dialog.</p> <p>Different ISPs can offer various LTE bands. Available legal bands will be shown on the screen based on the operational bands offered by YOUR ISP. In default, all the bands are enabled.</p> <p>Choose one or multiple bands if you want to change. If not, keep the default configuration.</p> <p>Enable Bridge Mode (Use LAN Port P1) - DHCP client (a PC or other router) connected to LAN Port P1 is able to get WAN IP to access Internet from LTE WAN interface.</p> <ul style="list-style-type: none"> ● Bridge Specific MAC Address - Enter the MAC address of the DHCP client (a PC or a router) manually to get the WAN IP.

After finishing all the settings here, please click **OK** to activate them.

II-2-2-2 Details Page for PPPoE in WAN2

To choose PPPoE as the accessing protocol of the Internet, please select PPPoE from the WAN>>Internet Access >>WAN2 page. The following web page will be shown.

WAN >> Internet Access

WAN 2

PPPoE	Static or Dynamic IP	PPTP	IPv6
<input type="radio"/> Enable <input checked="" type="radio"/> Disable			
ISP Access Setup Service Name (Optional) <input type="text" value="Max: 23 characters"/> Username <input type="text" value="Max: 63 characters"/> Password <input type="text" value="Max: 62 characters"/> Index(1-15) in Schedule Setup : => <input type="text"/> , <input type="text"/> , <input type="text"/> , <input type="text"/>		PPP/MP Setup PPP Authentication <input type="text" value="PAP or CHAP"/> Idle Timeout <input type="text" value="180"/> second(s)	
WAN Connection Detection Mode <input type="text" value="PPP Detect"/> Ping IP <input type="text"/> TTL:		IP Address Assignment Method (IPCP) <input type="button" value="WAN IP Alias"/> Fixed IP: <input type="radio"/> Yes <input checked="" type="radio"/> No (Dynamic IP) Fixed IP Address <input type="text"/>	
MTU <input type="text" value="1492"/> (Max:1492) Path MTU Discovery <input type="button" value="Detect"/>		<input checked="" type="radio"/> Default MAC Address <input type="radio"/> Specify a MAC Address MAC Address: <input type="text" value="00"/> · <input type="text" value="1D"/> · <input type="text" value="AA"/> : <input type="text" value="93"/> · <input type="text" value="9F"/> · <input type="text" value="3E"/>	
TTL Change the TTL value <input type="text" value="Enable"/>			

Available settings are explained as follows:

Item	Description
Enable/Disable	Click Enable for activating this function. If you click Disable , this function will be closed and all the settings that you adjusted in this page will be invalid.
ISP Access Setup	Enter your allocated username, password and authentication parameters according to the information provided by your ISP. Service Name - Enter the description of the specific network service. Username - Type in the username provided by ISP in this field. The maximum length of the user name you can set is 63 characters. Password - Type in the password provided by ISP in this field. The maximum length of the password you can set is 62 characters. Index (1-15) - You can type in four sets of time schedule for your request. All the schedules can be set previously in Applications >> Schedule web page and you can use the number that you have set in that web page.
WAN Connection	Such function allows you to verify whether network

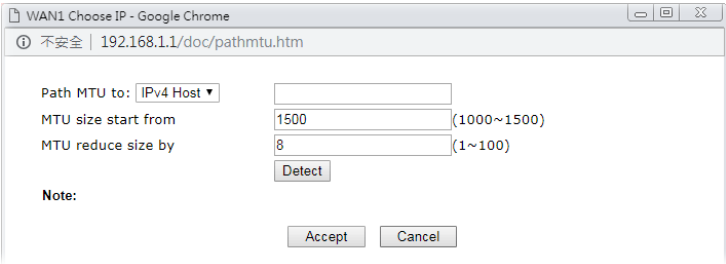
<p>Detection</p>	<p>connection is alive or not through PPP Detect or Ping Detect.</p> <p>Mode - Choose PPP Detect or Ping Detect for the system to execute for WAN detection. If you choose Ping Detect as the detection mode, you have to type required settings for the following items.</p> <ul style="list-style-type: none"> ● Primary/Secondary Ping IP - If you choose Ping Detect as detection mode, you have to type Primary or Secondary IP address in this field for pinging. ● Ping Gateway IP - If you choose Ping Detect as detection mode, you also can enable this setting to use current WAN gateway IP address for pinging. With the IP address(es) pinging, Vigor router can check if the WAN connection is on or off. ● TTL (Time to Live) - Set TTL value of PING operation. ● Ping Interval - Type the interval for the system to execute the PING operation. ● Ping Retry - Type the number of times that the system is allowed to execute the PING operation before WAN disconnection is judged.
<p>MTU</p>	<p>It means Max Transmit Unit for packet.</p> <p>Path MTU Discovery - It is used to detect the maximum MTU size of a packet not to be segmented in specific transmit path.</p> <p>Click Detect to open the following dialog.</p>  <ul style="list-style-type: none"> ● Path MTU to - Type the IP address as the specific transmit path. ● MTU size start from - Determine the starting point value of the packet. Default setting is 1500. ● MTU reduce size by - It determines the decreasing size of MTU value. For example, the number specified in this field is "8". The maximum MTU size is "1500". After clicking the "detect" button, the system will calculate and get the suitable MTU value such as 1500, 1492, 1484 and etc., automatically. ● Detect - Click it to detect a suitable MTU value ● Accept - After clicking it, the detected value will be displayed in the field of MTU.
<p>TTL</p>	<p>Change the TTL value - Enable or disable the TTL (Time to Live) for a packet transmitted through Vigor router.</p> <ul style="list-style-type: none"> ● Enable - TTL value will be reduced (-1) when it passess through Vigor router. It will cause the client, accessing Internet through Vigor router, be blocked by certain ISP when TTL value becomes "0". ● Disable - TTL value will not be reduced. Then, when a packet passes through Vigor router, it will not be cancelled. That is, the client who sends out the packet will not be blocked by ISP.

PPP/MP Setup

PPP Authentication - Select **PAP only** or **PAP or CHAP** for PPP.

Idle Timeout - Set the timeout for breaking down the Internet after passing through the time without any action.

IP Assignment (IPCP)- Usually ISP dynamically assigns IP address to you each time you connect to it and request. In some case, your ISP provides service to always assign you the same IP address whenever you request. In this case, you can fill in this IP address in the Fixed IP field. Please contact your ISP before you want to use this function.

WAN IP Alias - If you have multiple public IP addresses and would like to utilize them on the WAN interface, please use WAN IP Alias. You can set up to 8 public IP addresses other than the current one you are using. Notice that this setting is available for WAN1 only. Type the additional WAN IP address and check the Enable box. Then click OK to exit the dialog.

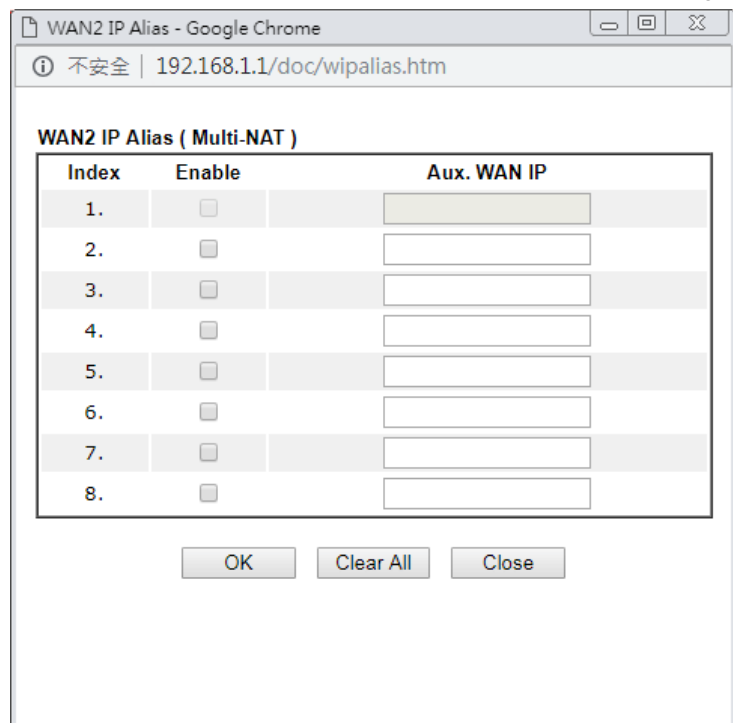

Index	Enable	Aux. WAN IP
1.	<input type="checkbox"/>	
2.	<input type="checkbox"/>	
3.	<input type="checkbox"/>	
4.	<input type="checkbox"/>	
5.	<input type="checkbox"/>	
6.	<input type="checkbox"/>	
7.	<input type="checkbox"/>	
8.	<input type="checkbox"/>	

OK Clear All Close

Fixed IP Address - Type in a fixed IP address.

Default MAC Address - You can use **Default MAC Address** or specify another MAC address by typing on the boxes of MAC Address for the router.

Specify a MAC Address - Type the MAC address for the router manually.

After finishing all the settings here, please click OK to activate them.

II-2-2-3 Details Page for Static or Dynamic IP in WAN2

For static IP mode, you usually receive a fixed public IP address or a public subnet, namely multiple public IP addresses from your DSL or Cable ISP service providers. In most cases, a Cable service provider will offer a fixed public IP, while a DSL service provider will offer a public subnet. If you have a public subnet, you could assign an IP address or many IP address to the WAN interface.

To use **Static or Dynamic IP** as the accessing protocol of the internet, please click the **Static or Dynamic IP** tab. The following web page will be shown.

WAN 2

PPPoE	Static or Dynamic IP	PPTP	IPv6
<input type="radio"/> Enable <input checked="" type="radio"/> Disable		WAN IP Network Settings WAN IP Alias	
Keep WAN Connection <input type="checkbox"/> Enable PING to keep alive PING to the IP <input type="text"/> PING Interval <input type="text"/> minute(s)		<input type="radio"/> Obtain an IP address automatically Router Name <input type="text"/> Max: 39 characters * Domain Name <input type="text"/> Max: 39 characters *	
WAN Connection Detection Mode <input type="text"/> ARP Detect ▾ Ping IP <input type="text"/> TTL: <input type="text"/>		<input checked="" type="radio"/> Specify an IP address IP Address <input type="text"/> Subnet Mask <input type="text"/> Gateway IP Address <input type="text"/>	
MTU <input type="text"/> 1492 (Max:1500) Path MTU Discovery <input type="text"/> Detect		<input checked="" type="radio"/> Default MAC Address <input type="radio"/> Specify a MAC Address MAC Address: <input type="text"/> 00 <input type="text"/> 1D <input type="text"/> AA : <input type="text"/> 93 <input type="text"/> 9F <input type="text"/> 3E	
RIP Protocol <input type="checkbox"/> Enable RIP		DNS Server IP Address Primary IP Address <input type="text"/> 8.8.8.8 Secondary IP Address <input type="text"/> 8.8.4.4	
TTL Change the TTL value <input type="text"/> Enable ▾			

*: Required for some ISPs

OK Cancel

Available settings are explained as follows:

Item	Description
Enable / Disable	Click Enable for activating this function. If you click Disable , this function will be closed and all the settings that you adjusted in this page will be invalid.
Keep WAN Connection	Normally, this function is designed for Dynamic IP environments because some ISPs will drop connections if there is no traffic within certain periods of time. Check Enable PING to keep alive box to activate this function. PING to the IP - If you enable the PING function, please specify the IP address for the system to PING it for keeping alive. PING Interval - Enter the interval for the system to execute the PING operation.
WAN Connection Detection	Such function allows you to verify whether network connection is alive or not through ARP Detect or Ping Detect. Mode - Choose ARP Detect , Ping Detect or Always On for the system to execute for WAN detection. If you choose Ping Detect as the detection mode, you have to type required settings for the following items. <ul style="list-style-type: none"> ● Primary/Secondary Ping IP - If you choose Ping Detect as detection mode, you have to type Primary or Secondary IP address in this field for pinging. ● Ping Gateway IP - If you choose Ping Detect as detection mode, you also can enable this setting to use current WAN gateway IP address for pinging.

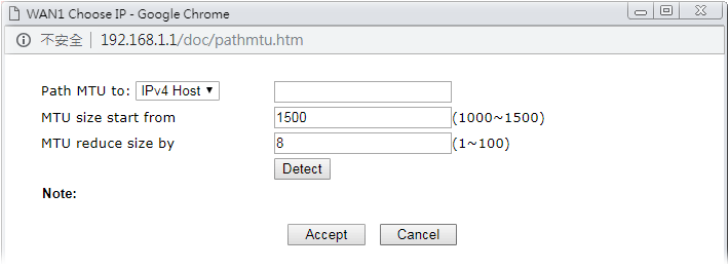
	<p>With the IP address(es) pinging, Vigor router can check if the WAN connection is on or off.</p> <ul style="list-style-type: none"> ● TTL (Time to Live) - Set TTL value of PING operation. ● Ping Interval - Enter the interval for the system to execute the PING operation. ● Ping Retry - Enter the number of times that the system is allowed to execute the PING operation before WAN disconnection is judged.
<p>MTU</p>	<p>It means Max Transmit Unit for packet.</p> <p>Path MTU Discovery - It is used to detect the maximum MTU size of a packet not to be segmented in specific transmit path.</p> <p>Click Detect to open the following dialog.</p>  <ul style="list-style-type: none"> ● Path MTU to - Choose the destination as the specific transmit path and Enter the IP address. ● MTU size start from - Determine the starting point value of the packet. ● MTU reduce size by - It determines the decreasing size of MTU value. For example, the number specified in this field is "8". The maximum MTU size is "1500". After clicking the "detect" button, the system will calculate and get the suitable MTU value such as 1500, 1492, 1484 and etc., automatically. ● Detect - Click it to detect a suitable MTU value ● Accept - After clicking it, the detected value will be displayed in the field of MTU.
<p>RIP Protocol</p>	<p>Routing Information Protocol is abbreviated as RIP(RFC1058) specifying how routers exchange routing tables information. Click Enable RIP for activating this function.</p>
<p>TTL</p>	<p>Change the TTL value - Enable or disable the TTL (Time to Live) for a packet transmitted through Vigor router.</p> <p>Enable - TTL value will be reduced (-1) when it pass through Vigor router. It will cause the client, accessing Internet through Vigor router, be blocked by certain ISP when TTL value becomes "0".</p> <p>Disable - TTL value will not be reduced. Then, when a packet passes through Vigor router, it will not be cancelled. That is, the client who sends out the packet will not be blocked by ISP.</p>
<p>WAN IP Network Settings</p>	<p>This group allows you to obtain an IP address automatically and allows you Enter IP address manually.</p> <p>WAN IP Alias - If you have multiple public IP addresses and would like to utilize them on the WAN interface, please use WAN IP Alias. You can set up to 8 public IP addresses other than the current one you are using.</p>

WAN1 IP Alias - Google Chrome
 不安全 | 192.168.1.1/doc/wipalias.htm

WAN1 IP Alias (Multi-NAT)

Index	Enable	Aux. WAN IP	Join NAT IP Pool
1.	<input checked="" type="checkbox"/>	---	<input checked="" type="checkbox"/>
2.	<input type="checkbox"/>	0.0.0.0	<input type="checkbox"/>
3.	<input type="checkbox"/>	0.0.0.0	<input type="checkbox"/>
4.	<input type="checkbox"/>	0.0.0.0	<input type="checkbox"/>
5.	<input type="checkbox"/>	0.0.0.0	<input type="checkbox"/>
6.	<input type="checkbox"/>	0.0.0.0	<input type="checkbox"/>
7.	<input type="checkbox"/>	0.0.0.0	<input type="checkbox"/>
8.	<input type="checkbox"/>	0.0.0.0	<input type="checkbox"/>

OK Clear All Close

Obtain an IP address automatically - Click this button to obtain the IP address automatically if you want to use Dynamic IP mode.

- **Router Name:** Enter the router name provided by ISP.
- **Domain Name:** Enter the domain name that you have assigned.

Specify an IP address - Click this radio button to specify some data if you want to use Static IP mode.

- **IP Address:** Enter the IP address.
- **Subnet Mask:** Enter the subnet mask.
- **Gateway IP Address:** Enter the gateway IP address.

Default MAC Address: Click this radio button to use default MAC address for the router.

Specify a MAC Address: Some Cable service providers specify a specific MAC address for access authentication. In such cases you need to click the **Specify a MAC Address** and enter the MAC address in the MAC Address field.

DNS Server IP Address

Enter the primary IP address for the router if you want to use Static IP mode. If necessary, Enter secondary IP address for necessity in the future.

After finishing all the settings here, please click OK to activate them.

II-2-2-4 Details Page for PPTP

To use PPTP as the accessing protocol of the internet, please click the PPTP tab. The following web page will be shown.

WAN >> Internet Access

WAN 2

PPPoE	Static or Dynamic IP	PPTP	IPv6
<input type="radio"/> Enable <input checked="" type="radio"/> Disable PPTP Server <input type="text"/> Max: 63 characters Specify Gateway IP Address <input type="text"/>		PPP Setup PPP Authentication <input type="text"/> PAP or CHAP ▾ Idle Timeout <input type="text"/> 180 second(s) IP Address Assignment Method (IPCP) <input type="button"/> WAN IP Alias Fixed IP: <input type="radio"/> Yes <input checked="" type="radio"/> No (Dynamic IP) Fixed IP Address <input type="text"/>	
ISP Access Setup Username <input type="text"/> Password <input type="text"/> Index(1-15) in Schedule Setup : => <input type="text"/> , <input type="text"/> , <input type="text"/> , <input type="text"/>		WAN IP Network Settings <input type="radio"/> Obtain an IP address automatically <input checked="" type="radio"/> Specify an IP address IP Address <input type="text"/> Subnet Mask <input type="text"/>	
MTU <input type="text"/> 1492 (Max:1460) Path MTU Discovery <input type="button"/> Detect			

OK Cancel

Available settings are explained as follows:

Item	Description
PPTP	<p>Enable - Click this radio button to enable a PPTP client to establish a tunnel to a DSL modem on the WAN interface.</p> <p>Disable - Click this radio button to close the connection through PPTP.</p> <p>PPTP Server - Specify the IP address of the PPTP server if you enable PPTP client mode.</p> <p>Specify Gateway IP Address - Specify the gateway IP address for DHCP server.</p>
ISP Access Setup	<p>Username -Enter the username provided by ISP in this field. The maximum length of the user name you can set is 63 characters.</p> <p>Password -Enter the password provided by ISP in this field. The maximum length of the password you can set is 62 characters.</p> <p>Index (1-15) in Schedule Setup - You can Enter four sets of time schedule for your request. All the schedules can be set previously in Application >> Schedule web page and you can use the number that you have set in that web page.</p>
MTU	<p>It means Max Transmit Unit for packet.</p> <p>Path MTU Discovery - It is used to detect the maximum MTU size of a packet not to be segmented in specific transmit path.</p> <p>Click Detect to open the following dialog.</p>

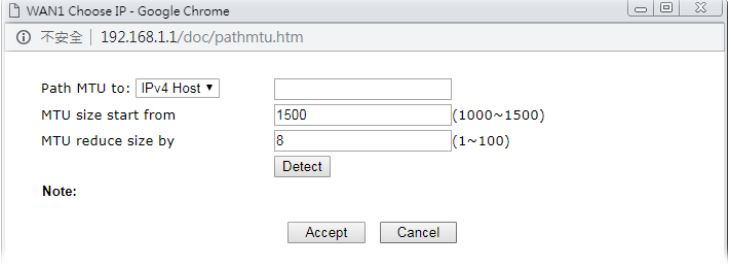
	 <ul style="list-style-type: none"> ● Path MTU to - Choose the destination as the specific transmit path and Enter the IP address. ● MTU size start from - Determine the starting point value of the packet. ● MTU reduce size by - It determines the decreasing size of MTU value. For example, the number specified in this field is "8". The maximum MTU size is "1500". After clicking the "detect" button, the system will calculate and get the suitable MTU value such as 1500, 1492, 1484 and etc., automatically. ● Detect - Click it to detect a suitable MTU value ● Accept - After clicking it, the detected value will be displayed in the field of MTU.
<p>PPP Setup</p>	<p>PPP Authentication - Select PAP only or PAP or CHAP for PPP.</p> <p>Idle Timeout - Set the timeout for breaking down the Internet after passing through the time without any action.</p>
<p>IP Address Assignment Method(IPCP)</p>	<p>WAN IP Alias - If you have multiple public IP addresses and would like to utilize them on the WAN interface, please use WAN IP Alias. You can set up to 8 public IP addresses other than the current one you are using.</p> <p>Fixed IP - Usually ISP dynamically assigns IP address to you each time you connect to it and request. In some case, your ISP provides service to always assign you the same IP address whenever you request. In this case, you can fill in this IP address in the Fixed IP field. Please contact your ISP before you want to use this function. Click Yes to use this function and Enter a fixed IP address in the box.</p> <p>Fixed IP Address -Type a fixed IP address.</p>
<p>WAN IP Network Settings</p>	<p>Obtain an IP address automatically - Click this button to obtain the IP address automatically.</p> <p>Specify an IP address - Click this radio button to specify some data.</p> <ul style="list-style-type: none"> ● IP Address - Enter the IP address. ● Subnet Mask - Enter the subnet mask.

After finishing all the settings here, please click OK to activate them.

II-2-2-5 Details Page for IPv6 – Offline

When Offline is selected, the IPv6 connection will be disabled.

Internet Access >> IPv6

WAN 2

Internet Access Mode Connection Type	<input type="text" value="Offline"/>
--	--------------------------------------

OK

II-2-2-6 Details Page for IPv6 – PPP

During the procedure of IPv4 PPPoE connection, we can get the IPv6 Link Local Address between the gateway and Vigor router through IPv6CP. Later, use DHCPv6 or accept RA to acquire the IPv6 prefix address (such as: 2001:B010:7300:200::/64) offered by the ISP. In addition, PCs under LAN also can have the public IPv6 address for Internet access by means of the generated prefix.

No need to type any other information for PPP mode.

Internet Access >> IPv6

WAN 2

Internet Access Mode Connection Type	<input type="text" value="PPP"/>
WAN Connection Detection Mode	<input type="text" value="NS Detect"/>
RIPng Protocol <input type="checkbox"/> Enable	

Note:

IPv4 WAN setting should be PPPoE / PPPoA client.

OK

Available settings are explained as follows:

Item	Description
WAN Connection Detection	<p>Such function allows you to verify whether network connection is alive or not through Ping Detect.</p> <p>Mode - Choose NS Detect, Always On or Ping Detect for the system to execute for WAN detection. Always On means no detection will be executed. The network connection will be on always.</p> <ul style="list-style-type: none"> ● Ping IP/Hostname - If you choose Ping Detect as detection mode, you have to type IP address in this field for pinging. ● TTL (Time to Live) -If you choose Ping Detect as detection mode, you have to type TTL value.

RIPng Protocol	RIPng (RIP next generation) offers the same functions and benefits as IPv4 RIP v2.
----------------	--

Below shows an example for successful IPv6 connection based on PPP mode.

Online Status

Physical Connection		System Uptime: 0:2:32	
IPv4	IPv6		
LAN Status			
IP Address			
2001:B010:7300:201:21D:AFF:FEA6:2568/64 (Global)			
FE80::21D:AFF:FEA6:2568/64 (Link)			
TX Packets	RX Packets	TX Bytes	RX Bytes
7	4	690	328
WAN2 IPv6 Status >> Drop PPP			
Enable	Mode	Up Time	
Yes	PPP	0:02:08	
IP		Gateway IP	
2001:B010:7300:201:21D:AFF:FEA6:256A/128 (Global)		FE80::90:1A00:242:AD52	
FE80::1D:AFF:FEA6:256A/128 (Link)			
DNS IP			
2001:8000:168::1			
2001:8000:168::2			
TX Packets	RX Packets	TX Bytes	RX Bytes
7	9	544	1126



Info

At present, the IPv6 prefix can be acquired via the PPPoE mode connection which is available for the areas such as Taiwan (hinet), the Netherlands, Australia and UK.

II-2-2-7 Details Page for IPv6 – TSPC

Tunnel setup protocol client (TSPC) is an application which could help you to connect to IPv6 network easily.

Please make sure your IPv4 WAN connection is OK and apply one free account from hexago (<http://gogonet.gogo6.com/page/freenet6-account>) before you try to use TSPC for network connection. TSPC would connect to tunnel broker and requests a tunnel according to the specifications inside the configuration file. It gets a public IPv6 IP address and an IPv6 prefix from the tunnel broker and then monitors the state of the tunnel in background.

After getting the IPv6 prefix and starting router advertisement daemon (RADVD), the PC behind this router can directly connect to IPv6 the Internet.

WAN 2

Internet Access Mode	
Connection Type	TSPC ▼
TSPC Configuration	
Username	<input type="text"/>
Password	<input type="text"/>
Tunnel Broker	<input type="text"/>
WAN Connection Detection	
Mode	NS Detect ▼

OK

Available settings are explained as follows:

Item	Description
Username	Enter the name obtained from the broker. It is suggested for you to apply another username and password for http://gogonet.gogo6.com/page/freenet6-account . The maximum length of the name you can set is 63 characters.
Password	Enter the password assigned with the user name. The maximum length of the name you can set is 19 characters.
Tunnel Broker	Enter the address for the tunnel broker IP, FQDN or an optional port number.
WAN Connection Detection	Such function allows you to verify whether network connection is alive or not through Ping Detect. Mode - Choose NS Detect , Always On or Ping Detect for the system to execute for WAN detection. Always On means no detection will be executed. The network connection will be on always. <ul style="list-style-type: none"> ● Ping IP/Hostname - If you choose Ping Detect as detection mode, you have to type IP address in this field for pinging. ● TTL (Time to Live) -If you choose Ping Detect as detection mode, you have to type TTL value.

After finished the above settings, click **OK** to save the settings.

II-2-2-8 Details Page for IPv6 – AICCU

Internet Access >> IPv6

WAN 2

Internet Access Mode	
Connection Type	AICCU ▼
AICCU Configuration	
<input type="checkbox"/> Always On	
Username	<input type="text"/>
Password	<input type="text"/>
Tunnel Broker	tic.sixxs.net
Tunnel ID	<input type="text"/>
Subnet Prefix	<input type="text"/> / <input type="text"/>
WAN Connection Detection	
Mode	NS Detect ▼

Note:

If "Always On" is not enabled, AICCU connection would only retry three times.

OK

Available settings are explained as follows:

Item	Description
Always On	Check this box to keep the network connection always.
Username	Enter the name obtained from the broker. Please apply new account at http://www.sixxs.net/ . It is suggested for you to apply another username and password. The maximum length of the name you can set is 19 characters.
Password	Enter the password assigned with the user name. The maximum length of the password you can set is 19 characters.
Tunnel Broker	It means a server of AICCU. The server can provide IPv6 tunnels to sites or end users over IPv4. Enter the address for the tunnel broker IP, FQDN or an optional port number.
Tunnel ID	One user account may have several tunnels. And, each tunnel shall have one specified tunnel ID (e.g., T115394). Enter the ID offered by Tunnel Broker.
Subnet Prefix	Enter the subnet prefix address obtained from service provider. The maximum length of the prefix you can set is 128 characters.
WAN Connection Detection	Such function allows you to verify whether network connection is alive or not through Ping Detect. Mode - Choose NS Detect, Always On or Ping Detect for the system to execute for WAN detection. ● Ping IP/Hostname - If you choose Ping Detect as detection mode, you have to type IP address in this field

for pinging.

- **TTL (Time to Live)** -If you choose **Ping Detect** as detection mode, you have to type TTL value.

After finished the above settings, click **OK** to save the settings.

II-2-2-9 Details Page for IPv6 – DHCPv6 Client

DHCPv6 client mode would use DHCPv6 protocol to obtain IPv6 address from server.

Internet Access >> IPv6

WAN 2

Internet Access Mode
Connection Type DHCPv6 Client ▼

DHCPv6 Client Configuration
IAID (Identity Association ID)

WAN Connection Detection
Mode NS Detect ▼

RIPng Protocol
 Enable

Available settings are explained as follows:

Item	Description
DHCPv6 Client Configuration	IAID - Type a number as IAID.
WAN Connection Detection	Such function allows you to verify whether network connection is alive or not through NS Detect or Ping Detect. Mode - Choose Always On , Ping Detect or NS Detect for the system to execute for WAN detection. With NS Detect mode, the system will check if network connection is established or not, like IPv4 ARP Detect. Always On means no detection will be executed. The network connection will be on always. <ul style="list-style-type: none">● Ping IP/Hostname - If you choose Ping Detect as detection mode, you have to type IP address in this field for pinging.● TTL (Time to Live) -If you choose Ping Detect as detection mode, you have to type TTL value.
RIPng Protocol	RIPng (RIP next generation) offers the same functions and benefits as IPv4 RIP v2.

After finished the above settings, click **OK** to save the settings.

II-2-2-10 Details Page for IPv6 – Static IPv6

This type allows you to setup static IPv6 address for WAN interface.

Internet Access >> IPv6

WAN 2

Internet Access Mode
 Connection Type: Static IPv6 ▼

Static IPv6 Address Configuration
 IPv6 Address: / Prefix Length:
 /

Current IPv6 Address Table

Index	IPv6 Address/Prefix Length	Scope

Static IPv6 Gateway Configuration
 IPv6 Gateway Address:

WAN Connection Detection
 Mode: NS Detect ▼

RIPng Protocol
 Enable

Available settings are explained as follows:

Item	Description
Static IPv6 Address configuration	IPv6 Address - Enter the IPv6 Static IP Address. Prefix Length - Enter the fixed value for prefix length. Add - Click it to add a new entry. Update - Click it to modify an existed entry. Delete - Click it to remove an existed entry.
Current IPv6 Address Table	Display current interface IPv6 address.
Static IPv6 Gateway Configuration	IPv6 Gateway Address - Type your IPv6 gateway address here.
WAN Connection Detection	Such function allows you to verify whether network connection is alive or not through Ping Detect. Mode - Choose NS Detect , Always On or Ping Detect for the system to execute for WAN detection. Always On means no detection will be executed. The network connection will be on always. ● Ping IP/Hostname - If you choose Ping Detect as detection mode, you have to type IP address in this field

	<p>for ping.</p> <ul style="list-style-type: none"> ● TTL (Time to Live) -If you choose Ping Detect as detection mode, you have to type TTL value.
RIPng Protocol	RIPng (RIP next generation) offers the same functions and benefits as IPv4 RIP v2.

After finished the above settings, click OK to save the settings.

II-2-2-11 Details Page for IPv6 – 6in4 Static Tunnel

This type allows you to setup 6in4 Static Tunnel for WAN interface.

Such mode allows the router to access IPv6 network through IPv4 network.

However, 6in4 offers a prefix outside of 2002::0/16. So, you can use a fixed endpoint rather than anycast endpoint. The mode has more reliability.

Internet Access >> IPv6

WAN 2

Internet Access Mode

Connection Type 6in4 Static Tunnel ▼

6in4 Static Tunnel

Remote Endpoint IPv4 Address

6in4 IPv6 Address / (default:64)

LAN Routed Prefix / (default:64)

Tunnel TTL (default:255)

WAN Connection Detection

Mode NS Detect ▼

OK

Available settings are explained as follows:

Item	Description
Remote Endpoint IPv4 Address	Enter the static IPv4 address for the remote server.
6in4 IPv6 Address	Enter the static IPv6 address for IPv4 tunnel with the value for prefix length.
LAN Routed Prefix	Enter the static IPv6 address for LAN routing with the value for prefix length.
Tunnel TTL	Enter the number for the data lifetime in tunnel.
WAN Connection Detection	<p>Such function allows you to verify whether network connection is alive or not through Ping Detect.</p> <p>Mode - Choose NS Detect, Always On or Ping Detect for the system to execute for WAN detection. Always On means no detection will be executed. The network connection will be on always.</p> <ul style="list-style-type: none"> ● Ping IP/Hostname - If you choose Ping Detect as detection mode, you have to type IP address in this field for ping. ● TTL (Time to Live) -If you choose Ping Detect as

detection mode, you have to type TTL value.

After finished the above settings, click OK to save the settings.

Below shows an example for successful IPv6 connection based on 6in4 Static Tunnel mode.

Online Status

Physical Connection		System Uptime: 0day 0:4:16	
IPv4	IPv6		
LAN Status			
IP Address			
2001:4DD0:FF00:83E4:21D:AAFF:FE83:11B4/64 (Global)			
FE80::21D:AAFF:FE83:11B4/64 (Link)			
TX Packets	RX Packets	TX Bytes	RX Bytes
14	80	1244	6815
WAN1 IPv6 Status			
Enable	Mode	Up Time	
Yes	6in4 Static Tunnel	0:04:07	
IP			Gateway IP
2001:4DD0:FF10:83E4::2131/64 (Global)			---
FE80::C0A8:651D/128 (Link)			
TX Packets	RX Packets	TX Bytes	RX Bytes
3	26	211	2302

II-2-2-12 Details Page for IPv6 – 6rd

This type allows you to setup 6rd for WAN interface.

Internet Access >> IPv6

WAN 2

Internet Access Mode	
Connection Type	6rd ▼
6rd Settings	
6rd Mode	<input type="radio"/> Auto 6rd <input checked="" type="radio"/> Static 6rd
Static 6rd Settings	
IPv4 Border Relay:	<input type="text"/>
IPv4 Mask Length:	0
6rd Prefix:	<input type="text"/>
6rd Prefix Length:	0
WAN Connection Detection	
Mode	Ping Detect ▼
Ping IP/Hostname	<input type="text"/>
TTL(1-255,0:Auto)	0

OK

Available settings are explained as follows:

Item	Description
6rd Mode	Auto 6rd - Retrieve 6rd prefix automatically from 6rd service provider. The IPv4 WAN must be set as "DHCP". Static 6rd - Set 6rd options manually.
IPv4 Border Relay	Enter the IPv4 addresses of the 6rd Border Relay for a given 6rd domain.
IPv4 Mask Length	Type a number of high-order bits that are identical across all CE IPv4 addresses within a given 6rd domain. It may be any value between 0 and 32.
6rd Prefix	Enter the 6rd IPv6 address.
6rd Prefix Length	Enter the IPv6 prefix length for the 6rd IPv6 prefix in number of bits.
WAN Connection Detection	Such function allows you to verify whether network connection is alive or not through Ping Detect. Mode - Choose NS Detect , Always On or Ping Detect for the system to execute for WAN detection. Always On means no detection will be executed. The network connection will be on always. <ul style="list-style-type: none"> ● Ping IP/Hostname - If you choose Ping Detect as detection mode, you have to type IP address in this field for pinging. ● TTL (Time to Live) -If you choose Ping Detect as detection mode, you have to type TTL value.

After finished the above settings, click OK to save the settings.

Below shows an example for successful IPv6 connection based on 6rd mode.

Online Status

Physical Connection		System Uptime: 0day 0:9:15	
IPv4	IPv6		
LAN Status			
IP Address			
2001:E41:A865:1D00:21D:AAFF:FE83:11B4/64 (Global)			
FE80::21D:AAFF:FE83:11B4/64 (Link)			
TX Packets	RX Packets	TX Bytes	RX Bytes
15	113	1354	18040
WAN1 IPv6 Status			
Enable	Mode	Up Time	
Yes	6rd	0:09:06	
IP		Gateway IP	
2001:E41:A865:1D01:21D:AAFF:FE83:11B5/128 (Global)		---	
FE80::C0A8:651D/128 (Link)			
TX Packets	RX Packets	TX Bytes	RX Bytes
13	29	967	2620

II-2-3 Multi-PVC/VLAN

Multi-VLAN allows users to create profiles for specific WAN interface and bridge connections for user applications that require very high network throughput. Simply go to **WAN** and select **Multi-VLAN**.

Channel 2 has the following fixed assignment and cannot be altered.

- Channel 2: Ethernet on WAN2 (based on the model)

Channels 5 through 7 can be configured as virtual WANs (WAN5 through WAN7).

General

This page shows the basic configurations used by every channel.

WAN >> Multi-PVC/VLAN

Multi-PVC/VLAN

General		Advanced			
Channel	Enable	WAN Type	VPI/VCI	VLAN Tag	Port-based Bridge
2	<input checked="" type="checkbox"/>	Ethernet(WAN2)		None	
<u>5</u> . WAN5	<input type="checkbox"/>	Ethernet(WAN2)		None	<input type="checkbox"/> Enable <input type="checkbox"/> P1 <input type="checkbox"/> P2
<u>6</u> . WAN6	<input type="checkbox"/>	Ethernet(WAN2)		None	<input type="checkbox"/> Enable <input type="checkbox"/> P1 <input type="checkbox"/> P2
<u>7</u> . WAN7	<input type="checkbox"/>	Ethernet(WAN2)		None	<input type="checkbox"/> Enable <input type="checkbox"/> P1 <input type="checkbox"/> P2

Note:

Channel 3 is reserved for LTE WAN.

OK

Cancel

Available settings are explained as follows:

Item	Description
Channel	Display the number of each channel. Channels 2 is used by the Internet Access web user interface and can not be configured here. Channels 5 ~ 7 are configurable.
Enable	Display whether the settings in this channel are enabled (Yes) or not (No).
WAN Type	Displays the physical medium that the channel will use.
VLAN Tag	Displays the VLAN tag value that will be used for the packets traveling on this channel.
Port-based Bridge	The network traffic flowing on each channel will be identified by the system via their VLAN Tags. Channels using the same WAN type may not configure the same VLAN tag value. Enable - Check this box to enable the port-based bridge function on this channel. P1 ~ P2 - Check the box(es) to build bridge connection on LAN.

To configure a PVC channel, click its channel number.

WAN links for Channel 5, 6 and 7 are provided for router-borne application such as TR-069. The settings must be applied and obtained from your ISP. For your special request, please contact with your ISP and then click WAN link of Channel 5, 6 and 7 to configure your router.

WAN >> Multi-PVC/VLAN >> Channel 5

Enable Channel 5:
 WAN Type : Ethernet(WAN2) ▼

General Settings
 VLAN Header
 VLAN Tag: 0
 Priority: 0 ▼

Note:
 Tag value must be set between 1~4095 and unique for each channel.
 Only one channel can be untagged (equal to 0) at a time.

Open Port-based Bridge Connection for this Channel
 Physical Members
 P1 P2

Note:
 P1 is reserved for NAT use, and cannot be configured for bridge mode.

Open WAN Interface for this Channel
 WAN Application: Management IPTV
 WAN Setup: Static or Dynamic IP ▼

<p>ISP Access Setup ISP Name Username Password PPP Authentication PAP or CHAP ▼ <input checked="" type="checkbox"/> Always On Idle Timeout -1 second(s) IP Address From ISP Fixed IP <input type="radio"/> Yes <input checked="" type="radio"/> No (Dynamic IP) Fixed IP Address </p>	<p>WAN IP Network Settings <input type="radio"/> Obtain an IP address automatically Router Name Vigor * Domain Name * *: Required for some ISPs <input checked="" type="radio"/> Specify an IP address IP Address Subnet Mask Gateway IP Address DNS Server IP Address Primary IP Address 8.8.8.8 Secondary IP Address 8.8.4.4</p>
---	---

OK
Cancel

Available settings are explained as follows:

Item	Description
Enable Channel 4/5/6	Enable - Select to enable this channel. Disable - Select to disable this channel.
General Settings	VLAN Tag - Enter the value as the VLAN ID number. Valid settings are in the range from 1 to 4095. The network traffic flowing on each channel will be identified by the system via their VLAN Tags. Channels using the same WAN type may not configure the same VLAN tag value. Priority - Choose the number to determine the packet priority for such VLAN. The range is from 0 to 7.
Open Port-based Bridge Connection for this Channel	The settings here will create a bridge between the LAN ports selected and the WAN. The WAN interface of the bridge connection will be built upon the WAN type selected using

	<p>the VLAN tag configured.</p> <p>Physical Members - Group the physical ports by checking the corresponding check box(es) for applying the port-based bridge connection.</p> <p>Note: LAN port P1 is reserved for NAT use and cannot be selected for bridging.</p>
Open WAN Interface for this Channel	<p>Check the box to enable relating function.</p> <p>WAN Application</p> <ul style="list-style-type: none"> ● Management can be specified for general management (Web configuration/telnet/TR069). If you choose Management, the configuration for this VLAN will be effective for Web configuration/telnet/TR069. ● IPTV - The IPTV configuration will allow the WAN interface to send IGMP packets to IPTV servers. <p>WAN Setup - Choose PPPoE/PPPoA or Static or Dynamic IP to determine what WAN settings must be configured.</p>
ISP Access Setup	<p>Enter your allocated username, password and authentication parameters according to the information provided by your ISP.</p> <p>ISP Name - PPP Service Name. Enter if your ISP requires this setting; otherwise leave blank.</p> <p>Username - Name provided by the ISP for PPPoE/PPPoA authentication. Maximum length is 62 characters.</p> <p>Password - Password provided by the ISP for PPPoE/PPPoA authentication. Maximum length is 62 characters.</p> <p>PPP Authentication -The protocol used for PPP authentication.</p> <ul style="list-style-type: none"> ● PAP only- Only PAP (Password Authentication Protocol) is used. ● PAP or CHAP- Both PAP and CHAP (Challenge-Handshake Authentication Protocol) can be used for PPP authentication. Router negotiates with the PPTP or L2TP server to determine which protocol to use. <p>Always On - If selected, the router will maintain the PPPoE/PPPoA connection.</p> <p>Idle Timeout - Maximum length of time, in seconds, of idling allowed (no traffic) before the connection is dropped.</p> <p>IP Address From ISP - Specifies how the WAN IP address of the channel configured.</p> <ul style="list-style-type: none"> ● Fixed IP Yes - IP address entered in the Fixed IP Address field will be used as the IP address of the virtual WAN. No - Virtual WAN IP address will be assigned by the ISP's PPPoE/PPPoA server.
WAN IP Network Settings	<p>Obtain an IP address automatically - Select this option if the router is to receive IP configuration information from a DHCP server.</p> <ul style="list-style-type: none"> ● Router Name - Sets the value of DHCP Option 12, which is used by some ISPs. ● Domain Name - Sets the value of DHCP Option 15, which is used by some ISPs. <p>Specify an IP address - Select this option to manually enter</p>

	<p>the IP address.</p> <ul style="list-style-type: none"> ● IP Address - Type in the IP address. ● Subnet Mask - Type in the subnet mask. ● Gateway IP Address - Type in gateway IP address. <p>DNS Server IP Address - Type in the primary IP address for the router if you want to use Static IP mode. If necessary, type in secondary IP address for necessity in the future.</p>
--	---

After finished the above settings, click OK to save the settings and return to previous page.

Advanced

Such configuration is applied to upstream packets. Such information will be provided by ISP. Please contact with your ISP for detailed information.

WAN >> Multi-PVC/VLAN

Multi-PVC/VLAN

General		Advanced			
ATM QoS					
Channel	QoS Type	PCR	SCR	MBS	PVC to PVC Binding
1.	UBR ▼	0	0	0	Disable ▼
5.	UBR ▼	0	0	0	Disable ▼
6.	UBR ▼	0	0	0	Disable ▼
7.	UBR ▼	0	0	0	Disable ▼

Note:

1. If the parameters in the ATM QoS settings are set to zero, then their default settings will be used. Also, PCR(max)=ADSL Up Speed /53/8.
2. Multiple channels may use the same ADSL channel link through the PVC Binding configuration. The PVC Binding configuration is only supported for channels using ADSL, please make sure the channel that you are binding to is using ADSL as its WAN type. The binding will work only under PPPoE and MPoA 1483 Bridge mode.
3. Channel 3 is reserved for LTE WAN.

Available settings are explained as follows:

Item	Description
QoS Type	Select a proper QoS type for the channel according to the information that your ISP provides.
PCR	It represents Peak Cell Rate. The default setting is "0".
SCR	It represents Sustainable Cell Rate. The value of SCR must be smaller than PCR.
MBS	It represents Maximum Burst Size. The range of the value is 10 to 50.
PVC to PVC Binding	It allows the enabled PVC channel to use the same ADSL connection settings of another PVC channel. Please choose the PVC channel via the drop down list.

After finished the above settings, click OK to save the settings.

Application Notes

A-1 How to configure IPv6 on WAN interface?

This document is going to demonstrate how to implement an IPv6 address on Vigor Router's WAN.

1. Before configuring IPv6 on WAN, please make sure the router is connected to the IPv4 Internet.

Online Status

Physical Connection System Uptime: 0day 0:3:29

IPv4		IPv6	
LAN Status	Primary DNS: 168.95.1.1	Secondary DNS: 168.95.192.1	
IP Address	TX Packets	RX Packets	
192.168.86.1	643	793	
WAN 1 Status >> Dial PPPoA			
Enable	Line	Name	Mode
Yes	ADSL		PPPoA
		Up Time	00:00:00
IP	GW IP	TX Packets	TX Rate(Bps)
---	---	0	0
		RX Packets	RX Rate(Bps)
		0	0
WAN 2 Status >> Drop PPPoE			
Enable	Line	Name	Mode
Yes	Ethernet		PPPoE
		Up Time	0:03:20
IP	GW IP	TX Packets	TX Rate(Bps)
118.106.103.103	168.95.192.1	79	3
		RX Packets	RX Rate(Bps)
		81	9

2. Go to WAN >> Internet Access, click on IPv6 of the WAN interface that you would like to configure an IPv6 address.

WAN >> Internet Access

Internet Access

Index	Display Name	Physical Mode	Access Mode	Details Page
WAN1		Fiber	PPPoE	IPv6
WAN3		USB	None	IPv6

You can configure DHCP client options here.

3. Select a Connection Type from the drop-down list, enter the required parameters. Then click OK and reboot the router to apply the settings.

WAN >> Internet Access ?

WAN 2

PPPoE	Static or Dynamic IP	PPTP/L2TP	IPv6
Internet Access Mode			
Connection Type			

Offline

Offline

PPP

TSPC

AICCU

DHCPv6 Client

Static IPv6

6in4 Static Tunnel

6rd

- After accomplishing the configurations, Network Administrator may check the status from the IPv6 tab on Online Status >> Physical Connection page.

Online Status

Physical Connection System Uptime: 0day 0:57:49

IPv4 IPv6

LAN Status			
IP Address			
2406:FA70:F1::C64/123 (Global)			
FE80::21D:5A7F:FE0A:47A0/64 (Link)			
TX Packets	RX Packets	TX Bytes	RX Bytes
1277	3060	182180	450067

WAN1 IPv6 Status		
Enable	Mode	Up Time
No	Offline	---
IP	Gateway IP	
---	---	

WAN2 IPv6 Status		
Enable	Mode	Up Time
Yes	Static IPv6	0:57:43
IP	Gateway IP	
2406:FA70:F1::C64/123 (Global)	2406:FA70:F1::C64	
2406:FA70:F1::C64/123 (Global)		
FE80::21D:5A7F:FE0A:47A0/64 (Link)		
TX Packets	RX Packets	TX Bytes
5180	2612	445044
		RX Bytes
		224316

- Furthermore, Network Administrator may test the connectivity of IPv6 from the router by going to Diagnostics >> Ping Diagnosis and selecting "IPv6".

Diagnostics >> Ping Diagnosis

Ping Diagnosis

IPV4 IPV6

Note: If you want to ping a LAN PC or you don't want to specify which WAN to ping through, please select "Unspecified".

Ping through: Unspecified ▾

Ping IPv6 Address:

Result | |

```
Pinging ipv6.google.com with 64 bytes of Data:
Receive reply from 2404:6800:4008:C04::66, time==400ms
Receive reply from 2404:6800:4008:C04::66, time==400ms
Receive reply from 2404:6800:4008:C04::66, time==400ms
Receive reply from 2404:6800:4008:C04::66, time==400ms
Receive reply from 2404:6800:4008:C04::66, time==400ms
Packets: Sent = 5, Received = 5, Lost = 0 (0% loss)
```

Below we will provide some examples of configuring IPv6 with different connection types.

PPP (Point-to-Point Protocol)

This applies if the IPv4 access mode is PPPoE, and the IPv4 ISP also provides an IPv6 address. To use IPv6 PPP, you just need to choose the **Connection Type** to "PPP", no other setting is required.

WAN >> Internet Access



WAN 2

PPPoE	Static or Dynamic IP	PPTP/L2TP	IPv6
Internet Access Mode			
Connection Type		PPP	
WAN Connection Detection			
Mode		Always On	
RIPng Protocol			
<input type="checkbox"/> Enable			

Note:

IPv4 WAN setting should be PPPoE / PPPoA client.

OK

Cancel

TSPC (Tunnel Setup Protocol Client)

In this mode, the IPv6 connectivity is provided by a tunnel broker on the IPv4 Internet through a tunnel set up by Tunnel Setup Protocol (TSP). To use TSPC, you'll need to sign up for a tunnel broker service and get a username and password first, then, configure the router as follows:

1. Set Connection Type to TSPC.
2. Enter the Username and Password registered at the TSP server.
3. Enter the IP or Domain Name of the TSPC server for **Tunnel Broker**.

WAN >> Internet Access



WAN 2

PPPoE	Static or Dynamic IP	PPTP/L2TP	IPv6
Internet Access Mode			
Connection Type		TSPC	
TSPC Configuration			
Username		mamepv6	
Password		*****	
Tunnel Broker		broker.aarnet.net.au	
WAN Connection Detection			
Mode		Always On	

OK

Cancel

Static IPv6

If your ISP provides a static IPv6 address for you, you may configure that IPv6 address for WAN by doing the following steps:

1. Set **Connection Type** to Static IPv6.
2. Enter the IPv6 address and Prefix Length which provided by the ISP, and click **Add**.

WAN >> Internet Access ?

WAN 2

PPPoE	Static or Dynamic IP	PPTP/L2TP	IPv6
Internet Access Mode			
Connection Type Static IPv6 ▼			
Static IPv6 Address Configuration			
IPv6 Address / Prefix Length			
2406:100:f1:3ea3		/ 123	<input type="button" value="Add"/> <input type="button" value="Delete"/>
Current IPv6 Address Table			
Index	IPv6 Address/Prefix Length	Scope	
1	FE80::6FFB:C69D/128	Link	

3. You should see the IPv6 address in **Current IPv6 Address Table**. Then, specify the IP address of IPv6 Gateway.

WAN >> Internet Access ?

WAN 2

PPPoE	Static or Dynamic IP	PPTP/L2TP	IPv6
Internet Access Mode			
Connection Type Static IPv6 ▼			
Static IPv6 Address Configuration			
IPv6 Address / Prefix Length			
		/	<input type="button" value="Add"/> <input type="button" value="Delete"/>
Current IPv6 Address Table			
Index	IPv6 Address/Prefix Length	Scope	
1	2406:100:f1:3ea3/123	Global	
2	FE80::21D:AAFF:FECE:2DD2/64	Link	

Static IPv6 Gateway configuration

IPv6 Gateway Address

2406:100:f1:3ea3

WAN Connection Detection

Mode Always On ▼

Bridge Mode

Enable Bridge Mode

Bridge Subnet LAN 1 ▼

6in4 Static Tunnel

In this mode, the IPv6 connectivity is provided by a tunnel broker on the IPv4 Internet through a tunnel configured manually. To use 6in4 Static Tunnel, you need sign up for a tunnel broker service and get an IPv6 address and routed IPv6 prefixes first. Then, configure the router as follows:

1. Set Connection Type to 6in4 Static Tunnel.
2. Enter the tunnel server's IPv4 address in Remote Endpoint IPv4 Address.
3. Enter the router's IPv6 address in 6in4 IPv6 Address.
4. Enter the routed IPv6 prefix in LAN Routed Prefix.

WAN >> Internet Access



WAN 2

PPPoE	Static or Dynamic IP	PPTP/L2TP	IPv6
Internet Access Mode			
Connection Type		6in4 Static Tunnel	
6in4 Static Tunnel			
Remote Endpoint IPv4 Address		216.219.221.16	
6in4 IPv6 Address		2001:47c:15:836::2 / 64 (default:64)	
LAN Routed Prefix		2001:47c:15:836:: / 64 (default:64)	
Tunnel TTL		255 (default:255)	
WAN Connection Detection			
Mode		Always On	

OK Cancel

II-3 LAN

Local Area Network (LAN) is a group of subnets regulated and ruled by router. The design of network structure is related to what type of public IP addresses coming from your ISP.

The most generic function of Vigor router is NAT. It creates a private subnet of your own. As mentioned previously, the router will talk to other public hosts on the Internet by using public IP address and talking to local hosts by using its private IP address. What NAT does is to translate the packets from public IP address to private IP address to forward the right packets to the right host and vice versa. Besides, Vigor router has a built-in DHCP server that assigns private IP address to each local host. See the following diagram for a briefly understanding.

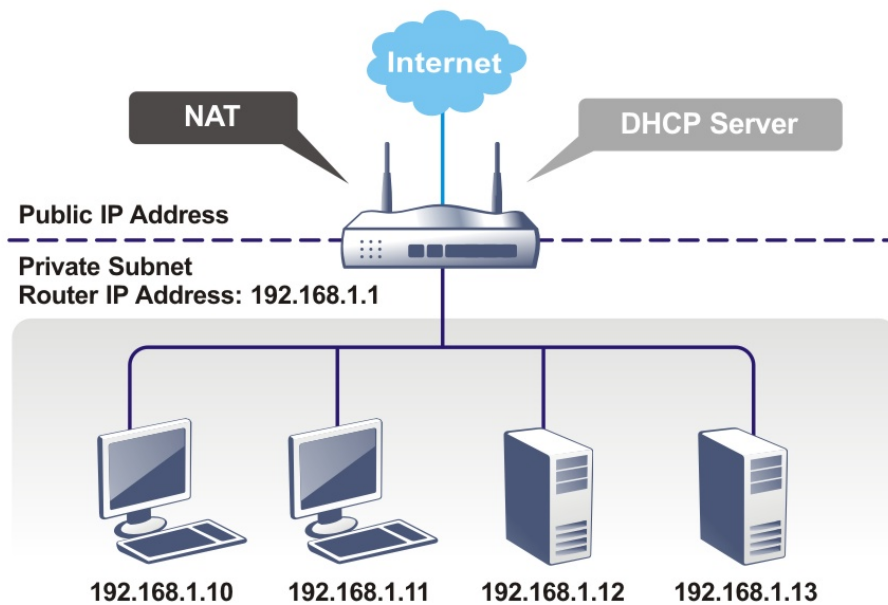

In some special case, you may have a public IP subnet from your ISP such as 220.135.240.0/24. This means that you can set up a public subnet or call second subnet that each host is equipped with a public IP address. As a part of the public subnet, the Vigor router will serve for IP routing to help hosts in the public subnet to communicate with other public hosts or servers outside. Therefore, the router should be set as the gateway for public hosts.

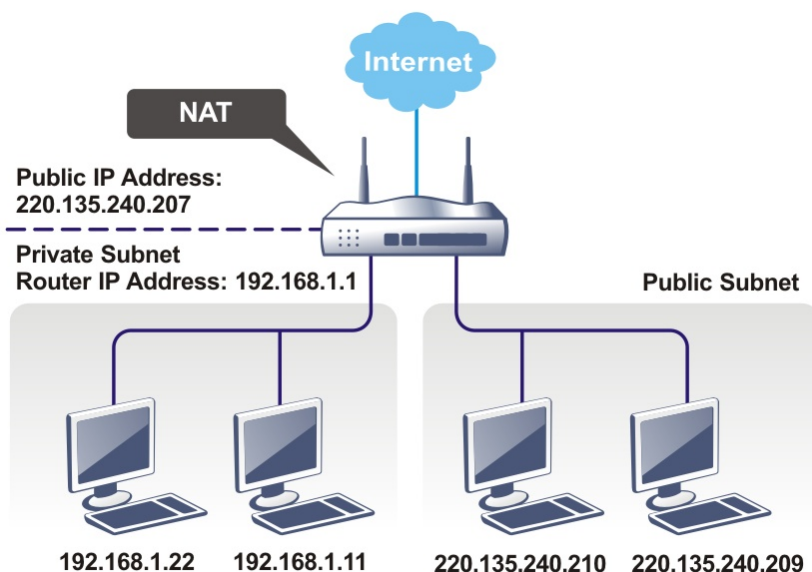

What is Routing Information Protocol (RIP)

Vigor router will exchange routing information with neighboring routers using the RIP to accomplish IP routing. This allows users to change the information of the router such as IP address and the routers will automatically inform for each other.

What is Static Route

When you have several subnets in your LAN, sometimes a more effective and quicker way for connection is the **Static routes** function rather than other method. You may simply set rules to forward data from one specified subnet to another specified subnet without the presence of RIP.

What are Virtual LANs and Rate Control

You can group local hosts by physical ports and create up to 8 virtual LANs. To manage the communication between different groups, please set up rules in Virtual LAN (VLAN) function and the rate of each.

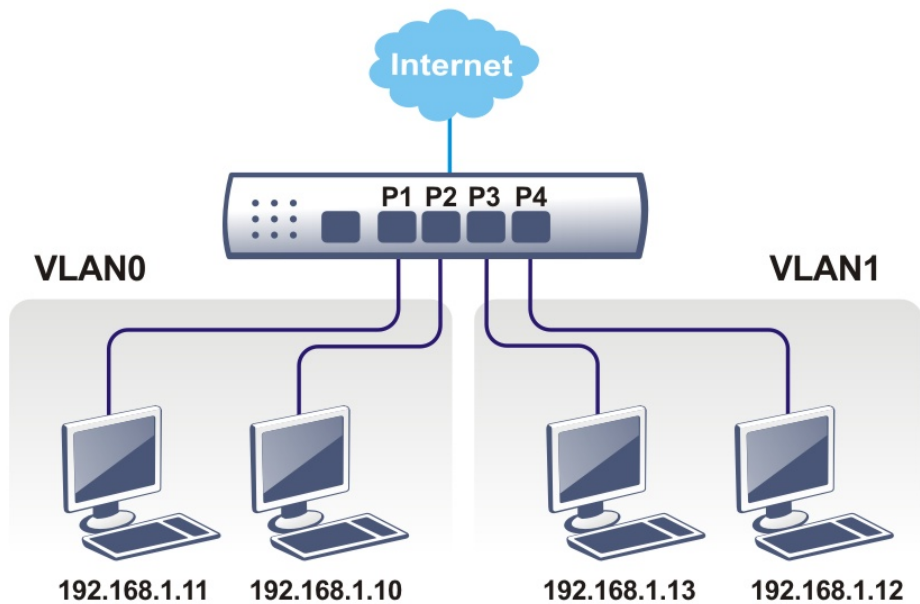

Web User Interface

A LAN comprises a collection of LAN clients, which are networked devices on your premises. A LAN client can be a computer, a printer, a Voice-over-IP (VoIP) phone, a mobile phone, a gaming console, an Internet Protocol Television (IPTV), etc, and can have either a wired (using Ethernet cabling) or wireless (using Wi-Fi) network connection.

LAN clients within the same LAN are normally able to communicate with one another directly, as they are peers to one another, unless measures, such as firewalls or VLANs, have been put in place to restrict such access. Nowadays the most common LAN firewalls are implemented on the LAN client itself. For example, Microsoft Windows since Windows XP and Apple OS X have built-in firewalls that can be configured to restrict traffic coming in and going out of the computer. VLANs, on the other hand, are usually set up using network switches or routers.

To communicate with the hosts outside of the LAN, LAN clients have to go through a network gateway, which in most cases is a router that sits between the LAN and the ISP network, which is the WAN. The router acts as a director to ensure traffic between the LAN and the WAN reach their intended destinations.

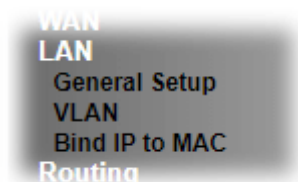

II-3-1 General Setup

This page provides you the general settings for LAN. Click **LAN** to open the LAN settings page and choose **General Setup**.

There are four subnets provided by the router which allow users to divide groups into different subnets (LAN1 - LAN4). In addition, different subnets can link for each other by configuring **Inter-LAN Routing**. At present, LAN1 setting is fixed with NAT mode only. LAN2 - LAN4 can be operated under NAT or **Route** mode. IP Routed Subnet can be operated under Route mode.

LAN >> General Setup

General Setup

Index	Enable	DHCP	DHCPv6	IP Address		
LAN 1	<input checked="" type="checkbox"/>	<input checked="" type="checkbox"/>	<input checked="" type="checkbox"/>	192.168.1.1	Details Page	IPv6
LAN 2	<input type="checkbox"/>	<input checked="" type="checkbox"/>	<input checked="" type="checkbox"/>	192.168.2.1	Details Page	IPv6
IP Routed Subnet	<input type="checkbox"/>	<input checked="" type="checkbox"/>		192.168.0.1	Details Page	

[DHCP Server Option](#)

Note:

Please enable LAN 2 on [LAN >> VLAN](#) page before configure them.

Force router to use "DNS server IP address" settings specified in [LAN1](#)

Inter-LAN Routing

Subnet	LAN 1	LAN 2
LAN 1	<input checked="" type="checkbox"/>	<input type="checkbox"/>
LAN 2	<input type="checkbox"/>	<input checked="" type="checkbox"/>

[OK](#)

Available settings are explained as follows:

Item	Description
General Setup	<p>Allow to configure settings for each subnet respectively.</p> <p>Index - Display all of the LAN items.</p> <p>Enable- Basically, LAN1 status is enabled in default. LAN2 and IP Routed Subnet can be observed by checking the Enable box.</p> <p>DHCPv6- LAN1 is configured with DHCP in default. If required, please check the DHCP box for each LAN.</p> <p>IP Address - Display the IP address for each LAN item. Such information is set in default and you can not modify it.</p> <p>Details Page - Click it to access into the setting page. Each LAN will have different LAN configuration page. Each LAN must be configured in different subnet.</p> <p>IPv6 - Click it to access into the settings page of IPv6.</p>
DHCP Server Option	<p>DHCP packets can be processed by adding option number and data information when such function is enabled.</p> <p>For detailed information, refer to later section.</p>
Force router to use "DNS server IP address"	<p>Force Vigor router to use DNS servers configured in LAN1/LAN2 instead of DNS servers given by the Internet Access server (PPPoE, PPTP or DHCP server).</p>
Inter-LAN Routing	<p>Check the box to link two or more different subnets (LAN and LAN).</p> <p>Inter-LAN Routing allows different LAN subnets to be interconnected or isolated.</p> <p>It is only available when the VLAN functionality is enabled. Refer to section II-2-2 VLAN on how to set up VLANs.</p> <p>In the Inter-LAN Routing matrix, a selected checkbox means that the 2 intersecting LANs can communicate with each other.</p>

When you finish the configuration, please click **OK** to save and exit this page.



Info

To configure a subnet, select its Details Page button to bring up the LAN Details Page.

II-3-1-1 Details Page for LAN1 – Ethernet TCP/IP and DHCP Setup

There are two configuration pages for LAN1, Ethernet TCP/IP and DHCP Setup (based on IPv4) and IPv6 Setup. Click the tab for each type and refer to the following explanations for detailed information.

LAN >> General Setup

LAN 1 Ethernet TCP / IP and DHCP Setup	LAN 1 IPv6 Setup
<p>Network Configuration For NAT Usage</p> <p>IP Address <input type="text" value="192.168.1.1"/></p> <p>Subnet Mask <input type="text" value="255.255.255.0"/></p> <hr/> <p>RIP Protocol Control <input type="button" value="Disable ▾"/></p>	<p>DHCP Server Configuration</p> <p><input type="radio"/> Disable <input checked="" type="radio"/> Enable Server <input type="radio"/> Enable Relay Agent</p> <p>Start IP Address <input type="text" value="192.168.1.10"/></p> <p>IP Pool Counts <input type="text" value="200"/> (max. 253)</p> <p>Gateway IP Address <input type="text" value="192.168.1.1"/></p> <p>Lease Time <input type="text" value="86400"/> (s)</p> <p><input checked="" type="checkbox"/> Clear DHCP lease for inactive clients periodically</p> <hr/> <p>DNS Server IP Address</p> <p>Primary IP Address <input type="text"/></p> <p>Secondary IP Address <input type="text"/></p>

Available settings are explained as follows:

Item	Description
Network Configuration	<p>For NAT Usage,</p> <p>IP Address - This is the IP address of the router. (Default: 192.168.1.1).</p> <p>Subnet Mask - The subnet mask, together with the IP Address field, indicates the maximum number of clients allowed on the subnet. (Default: 255.255.255.0/ 24).</p> <p>RIP Protocol Control,</p> <p>Enable - When Enabled, the router will attempt to exchange routing information with neighbouring routers using the Routing Information Protocol.</p>
DHCP Server Configuration	<p>DHCP stands for Dynamic Host Configuration Protocol. The router by factory default acts a DHCP server for your network so it automatically dispatches related IP settings to any local user configured as a DHCP client. It is highly recommended that you leave the router enabled as a DHCP server if you do not have a DHCP server for your network.</p> <p>If you want to use another DHCP server in the network other than the Vigor Router's, you can let Relay Agent help you to redirect the DHCP request to the specified location.</p> <p>Disable - Let you manually assign IP address to every host in the LAN.</p> <p>Enable Server - Let the router assign IP address to every host in the LAN.</p> <ul style="list-style-type: none"> ● Start IP Address - The beginning LAN IP address that is

given out to LAN DHCP clients.

- **IP Pool Counts** - The maximum number of IP addresses to be handed out by DHCP. The default value is 200. Valid range is between 1 and 253. The actual number of IP addresses available for assignment is the IP Pool Counts, or 253 minus the last octet of the Start IP Address, whichever is smaller.
- **Gateway IP Address** - The IP address of the gateway, which is the host on the LAN that relays all traffic coming into and going out of the LAN. The gateway is normally the router, and therefore the Gateway IP Address should be identical to the IP Address in the **Network Configuration** section above.
- **Lease Time** - The maximum duration DHCP-issued IP addresses can be used before they have to be renewed.
- **Clear DHCP lease for inactive clients periodically** - If selected, the router sends ARP requests recycles IP addresses previously assigned to inactive DHCP clients to prevent exhaustion of the IP address pool.

Note: When Clear DHCP lease for inactive clients periodically is enabled, router will do the following:

- Check activities of DHCP clients by ARP requests every minute when the available DHCP IP addresses are less than 30
- Clear DHCP lease when the client is not responding ARP replies.

Enable Relay Agent - When selected, all DHCP requests are forwarded to a DHCP server outside of the LAN subnet, and whose address is specified in the DHCP Server IP Address field.

- **DHCP Server IP Address** - It is available when **Enable Relay Agent** is checked. Set the IP address of the DHCP server you are going to use so the Relay Agent can help to forward the DHCP request to the DHCP server.

DNS Server IP Address

DNS stands for Domain Name System. Every Internet host must have a unique IP address, also they may have a human-friendly, easy to remember name such as www.yahoo.com. The DNS server converts the user-friendly name into its equivalent IP address.

Primary IP Address - You must specify a DNS server IP address here because your ISP should provide you with usually more than one DNS Server.

Secondary IP Address - You can specify secondary DNS server IP address here because your ISP often provides you more than one DNS Server.

The default DNS Server IP address can be found via Online Status:

Online Status

Physical Connection		System Uptime: 22:22:45	
IPV4	IPV6		
LAN Status	Primary DNS: 8.8.8.8	Secondary DNS: 8.8.4.4	
IP Address	TX Packets	RX Packets	
192.168.1.1	0	41533	

If both the Primary IP and Secondary IP Address fields are left empty, the router will assign its own IP address to local users as a DNS proxy server and maintain a DNS cache.

If the IP address of a domain name is already in the DNS cache, the router will resolve the domain name immediately. Otherwise, the router forwards the DNS query packet to the external DNS server by establishing a WAN (e.g. DSL/Cable) connection.

When you finish the configuration, please click **OK** to save and exit this page.

Private IP addresses can be assigned automatically to LAN clients using Dynamic Host Configuration Protocol (DHCP), or manually assigned. The DHCP server can either be the router (the most common case), or a separate server, that hands out IP addresses to DHCP clients.

Alternatively, static IP addresses can be manually configured on LAN clients as part of their network settings. No matter how IP addresses are configured, it is important that no two devices get the same IP address. If both DHCP and static assignment are used on a network, it is important to exclude the static IP addresses from the DHCP IP pool. For example, if your LAN uses the 192.168.1.x subnet and you have 20 DHCP clients and 20 static IP clients, you could configure 192.168.1.10 as the Start IP Address, 50 as the IP Pool Counts (enough for the current number of DHCP clients, plus room for future expansion), and use addresses greater than 192.168.1.100 for static assignment.

II-3-1-2 Details Page for LAN2

LAN >> General Setup

LAN 2 Ethernet TCP / IP and DHCP Setup	LAN 2 IPv6 Setup
Network Configuration <input checked="" type="radio"/> Enable <input type="radio"/> Disable <input checked="" type="radio"/> For NAT Usage <input type="radio"/> For Routing Usage IP Address: <input type="text" value="192.168.2.1"/> Subnet Mask: <input type="text" value="255.255.255.0"/>	DHCP Server Configuration <input type="radio"/> Disable <input checked="" type="radio"/> Enable Server <input type="radio"/> Enable Relay Agent Start IP Address: <input type="text" value="192.168.2.10"/> IP Pool Counts: <input type="text" value="100"/> (max. 253) Gateway IP Address: <input type="text" value="192.168.2.1"/> Lease Time: <input type="text" value="259200"/> (s) <input checked="" type="checkbox"/> Clear DHCP lease for inactive clients periodically.
	DNS Server IP Address Primary IP Address: <input type="text"/> Secondary IP Address: <input type="text"/>

OK

Available settings are explained as follows:

Item	Description
Network Configuration	<p>Enable/Disable - Click Enable to enable such configuration; click Disable to disable such configuration.</p> <p>For NAT Usage - Click this radio button to invoke NAT function.</p> <p>For Routing Usage - Click this radio button to invoke this function.</p> <p>IP Address - This is the IP address of the router. (Default: 192.168.1.1).</p> <p>Subnet Mask - The subnet mask, together with the IP Address field, indicates the maximum number of clients allowed on the subnet. (Default: 255.255.255.0/ 24).</p>
DHCP Server	DHCP stands for Dynamic Host Configuration Protocol. The

<p>Configuration</p>	<p>router by factory default acts a DHCP server for your network so it automatically dispatch related IP settings to any local user configured as a DHCP client. It is highly recommended that you leave the router enabled as a DHCP server if you do not have a DHCP server for your network.</p> <p>Disable Server - Let you manually assign IP address to every host in the LAN.</p> <p>Enable Server - Let the router assign IP address to every host in the LAN.</p> <ul style="list-style-type: none"> ● Start IP Address - The beginning LAN IP address that is given out to LAN DHCP clients. ● IP Pool Counts - The maximum number of IP addresses to be handed out by DHCP. The default value is 100. Valid range is between 1 and 253. The actual number of IP addresses available for assignment is the IP Pool Counts, or 253 minus the last octet of the Start IP Address, whichever is smaller. ● Gateway IP Address - The IP address of the gateway, which is the host on the LAN that relays all traffic coming into and going out of the LAN. The gateway is normally the router, and therefore the Gateway IP Address should be identical to the IP Address in the Network Configuration section above. ● Lease Time - The maximum duration DHCP-issued IP addresses can be used before they have to be renewed. ● Clear DHCP lease for inactive clients periodically - If selected, the router sends ARP requests recycles IP addresses previously assigned to inactive DHCP clients to prevent exhaustion of the IP address pool. <ul style="list-style-type: none"> ■ Note: When Clear DHCP lease for inactive clients periodically is enabled, router will do the following: <ul style="list-style-type: none"> ■ Check activities of DHCP clients by ARP requests every minute when the available DHCP IP addresses are less than 30 ■ Clear DHCP lease when the client is not responding ARP replies. <p>Enable Relay Agent - When selected, all DHCP requests are forwarded to a DHCP server outside of the LAN subnet, and whose address is specified in the DHCP Server IP Address field.</p> <ul style="list-style-type: none"> ● DHCP Server IP Address - It is available when Enable Relay Agent is checked. Set the IP address of the DHCP server you are going to use so the Relay Agent can help to forward the DHCP request to the DHCP server.
<p>DNS Server IP Address</p>	<p>DNS stands for Domain Name System. Every Internet host must have a unique IP address, also they may have a human-friendly, easy to remember name such as www.yahoo.com. The DNS server converts the user-friendly name into its equivalent IP address.</p> <p>Primary IP Address -You must specify a DNS server IP address here because your ISP should provide you with usually more than one DNS Server.</p> <p>Secondary IP Address - You can specify secondary DNS server IP address here because your ISP often provides you more than one DNS Server.</p> <p>The default DNS Server IP address can be found via Online</p>

	Status: Online Status <hr/> Physical Connection System Uptime: 22:22:45 <table border="1" style="width: 100%; border-collapse: collapse;"> <thead> <tr> <th style="width: 30%;">IPv4</th> <th style="width: 30%;">IPv6</th> <th style="width: 30%;"></th> </tr> </thead> <tbody> <tr> <td>LAN Status</td> <td>Primary DNS: 8.8.8.8</td> <td>Secondary DNS: 8.8.4.4</td> </tr> <tr> <td>IP Address</td> <td>TX Packets</td> <td>RX Packets</td> </tr> <tr> <td>192.168.1.1</td> <td>0</td> <td>41533</td> </tr> </tbody> </table> <p>If both the Primary IP and Secondary IP Address fields are left empty, the router will assign its own IP address to local users as a DNS proxy server and maintain a DNS cache.</p> <p>If the IP address of a domain name is already in the DNS cache, the router will resolve the domain name immediately. Otherwise, the router forwards the DNS query packet to the external DNS server by establishing a WAN (e.g. DSL/Cable) connection.</p>	IPv4	IPv6		LAN Status	Primary DNS: 8.8.8.8	Secondary DNS: 8.8.4.4	IP Address	TX Packets	RX Packets	192.168.1.1	0	41533
IPv4	IPv6												
LAN Status	Primary DNS: 8.8.8.8	Secondary DNS: 8.8.4.4											
IP Address	TX Packets	RX Packets											
192.168.1.1	0	41533											

When you finish the configuration, please click OK to save and exit this page.

II-3-1-3 Details Page for IP Routed Subnet

LAN >> General Setup

TCP/IP and DHCP Setup for IP Routed Subnet

Network Configuration <input type="radio"/> Enable <input checked="" type="radio"/> Disable For Routing Usage IP Address: <input type="text" value="192.168.0.1"/> Subnet Mask: <input type="text" value="255.255.255.0 / 24"/> <hr/> RIP Protocol Control: <input type="text" value="Disable"/>	DHCP Server Configuration Start IP Address: <input type="text"/> IP Pool Counts: <input type="text" value="0"/> (max. 32) Lease Time: <input type="text" value="259200"/> (s) <input type="checkbox"/> Use LAN Port <input checked="" type="checkbox"/> P1 <input checked="" type="checkbox"/> P2 <input checked="" type="checkbox"/> Use MAC Address <table border="1" style="width: 100%; border-collapse: collapse;"> <thead> <tr> <th style="width: 10%;">Index</th> <th style="width: 40%;">Matched MAC Address</th> <th style="width: 50%;">given IP Address</th> </tr> </thead> <tbody> <tr> <td style="height: 50px;"></td> <td></td> <td></td> </tr> </tbody> </table> MAC Address: <input type="text"/> : <input type="text"/> : <input type="text"/> : <input type="text"/> : <input type="text"/> : <input type="text"/> <input type="button" value="Add"/> <input type="button" value="Delete"/> <input type="button" value="Edit"/> <input type="button" value="Cancel"/>	Index	Matched MAC Address	given IP Address			
Index	Matched MAC Address	given IP Address					

Available settings are explained as follows:

Item	Description
Network Configuration	Enable/Disable - Click Enable to enable such configuration; click Disable to disable such configuration. For Routing Usage, IP Address - This is the IP address of the router. (Default: 192.168.1.1). Subnet Mask - The subnet mask, together with the IP Address field, indicates the maximum number of clients allowed on the subnet. (Default: 255.255.255.0/ 24). RIP Protocol Control, Enable - When Enabled, the router will attempt to exchange routing information with neighbouring routers using the

	Routing Information Protocol.
DHCP Server Configuration	<p>DHCP stands for Dynamic Host Configuration Protocol. The router by factory default acts a DHCP server for your network so it automatically dispatch related IP settings to any local user configured as a DHCP client. It is highly recommended that you leave the router enabled as a DHCP server if you do not have a DHCP server for your network.</p> <p>If you want to use another DHCP server in the network other than the Vigor Router's, you can let Relay Agent help you to redirect the DHCP request to the specified location.</p> <p>Start IP Address - The beginning LAN IP address that is given out to LAN DHCP clients.</p> <p>IP Pool Counts - The maximum number of IP addresses to be handed out by DHCP. The default value is 100. Valid range is between 1 and 253. The actual number of IP addresses available for assignment is the IP Pool Counts, or 253 minus the last octet of the Start IP Address, whichever is smaller.</p> <p>Lease Time - The maximum duration DHCP-issued IP addresses can be used before they have to be renewed.</p> <p>Use LAN Port - Specify an IP for IP Route Subnet. If it is enabled, DHCP server will assign IP address automatically for the clients coming from P1 and/or P2. Please check the box of P1 and P2.</p> <p>Use MAC Address - Check such box to specify MAC address.</p> <ul style="list-style-type: none"> ● MAC Address: Enter the MAC Address of the host one by one and click Add to create a list of hosts which can be assigned, deleted or edited from above pool. Set a list of MAC Address for 2nd DHCP server will help router to assign the correct IP address of the correct subnet to the correct host. So those hosts in 2nd subnet won't get an IP address belonging to 1st subnet. <p>Add - Enter the MAC address in the boxes and click this button to add.</p> <p>Delete - Click it to delete the selected MAC address.</p> <p>Edit - Click it to edit the selected MAC address.</p> <p>Cancel - Click it to cancel the job of adding, deleting and editing.</p>

When you finish the configuration, please click **OK** to save and exit this page.

II-3-1-4 Details Page for LAN IPv6 Setup

There are two configuration pages for each LAN. Click the tab for each type and refer to the following explanations for detailed information. Below shows the settings page for IPv6.

LAN >> General Setup

LAN 1 Ethernet TCP / IP and DHCP Setup
LAN 1 IPv6 Setup

Enable IPv6
 WAN Primary Interface WAN1 ▼

Static IPv6 Address

IPv6 Address / Prefix Length

/

Unique Local Address(ULA) configuration

Off ▼ :: / 64

Current IPv6 Address Table

Index	IPv6 Address/Prefix Length	Scope
1	FE80::21D:AAFF:FE93:9F3C/64	Link

DNS Server IPv6 Address Deploy when WAN is up ▼

Primary DNS Server 2001:4860:4860::8888

Secondary DNS Server 2001:4860:4860::8844

Management SLAAC(stateless) ▼

Other Option(O-bit)

DHCPv6 Server

Enable Server Disable Server

IPv6 Address Random Allocation

Auto IPv6 range

Start IPv6 Address ::

End IPv6 Address ::

Advance setting

Advance setting

It provides 2 daemons for LAN side IPv6 address configuration. One is SLAAC(stateless) and the other is DHCPv6 (Stateful) server.

Available settings are explained as follows:

Item	Description
Enable IPv6	Check the box to enable the configuration of LAN 1 IPv6 Setup.
WAN Primary Interface	Use the drop down list to specify a WAN interface for IPv6.
Static IPv6 Address	IPv6 Address -Type static IPv6 address for LAN.

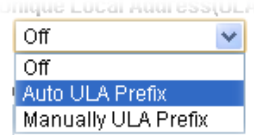
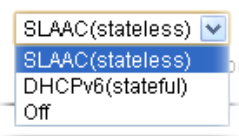
	<p>Prefix Length - Enter the fixed value for prefix length.</p> <p>Add - Click it to add a new entry.</p> <p>Delete - Click it to remove an existed entry.</p>
Unique Local Address (ULA) configuration	<p>Unique Local Addresses (ULAs) are private IPv6 addresses assigned to LAN clients.</p> <p>Off - ULA is disabled.</p> <p>Manually ULA Prefix - LAN clients will be assigned ULAs generated based on the prefix manually entered.</p> <p>Auto ULA Prefix - LAN clients will be assigned ULAs using an automatically-determined prefix.</p> 
Current IPv6 Address Table	Display current used IPv6 addresses.
DNS Server IPv6 Address	<p>Deploy when WAN is up - The RA (router advertisement) packets will be sent to LAN PC with DNS server information only when network connection by any one of WAN interfaces is up.</p> <p>Enable - The RA (router advertisement) packets will be sent to LAN PC with DNS server information no matter WAN connection is up or not.</p> <ul style="list-style-type: none"> ● Primary DNS Server - Enter the IPv6 address for Primary DNS server. ● Secondary DNS Server -Type another IPv6 address for DNS server if required. <p>Disable - DNS server will not be used.</p>
Management	<p>Configures the Managed Address Configuration flag (M-bit) in Route Advertisements.</p> <ul style="list-style-type: none"> ● Off - No configuration information is sent using Route Advertisements. ● SLAAC(stateless) - M-bit is unset. ● DHCPv6(stateful) - M-bit is set, which indicates to LAN clients that they should acquire all IPv6 configuration information from a DHCPv6 server. The DHCPv6 server can either be the one built into the Vigor2860, or a separate DHCPv6 server. 
Other Option(O-bit)	<p>When selected, the Other Configuration flag is set, which indicates to LAN clients that IPv6 configuration information besides LAN IPv6 addresses is available from a DHCPv6 server.</p> <p>Setting the M-bit (see Management above) has the same effect as implicitly setting the O-bit, as DHCPv6 supplies all IPv6 configuration information, including what is indicated as available when the O-bit is set.</p>
DHCPv6 Server	Enable Server -Click it to enable DHCPv6 server. DHCPv6

Server could assign IPv6 address to PC according to the Start/End IPv6 address configuration.

Disable Server -Click it to disable DHCPv6 server.

IPv6 Address Random Allocation -

Auto IPv6 range - After check the box, Vigor router will assign the IPv6 range automatically.

Start IPv6 Address / End IPv6 Address -Enter the start and end address for IPv6 server.

Advance setting - Click the Edit button to configure advanced IPv6 settings for DHCPv6 server.

LAN >> General Setup

DHCPv6 Server
Authentication Protocol: None
Prefix Delegation: Enable Disable
Prefix: /
DHCPv6 Prefix Delegation
New Prefix: : : : : /64
Suffix: : : : :
New Prefix Length: (0~64)
Client Link Local Address:
Client DUID(option):
Add
Prefix Prefix Length Link Local DUID
OK Cancel

Advance setting

The Advanced Settings page has additional settings for Router Advertisement and enabling multiple WANs for IPv6 traffic.

Router Advertisement Configuration
 Enable Disable
Hop Limit: 64
Min Interval Time(sec): 200
Max Interval Time(sec): 600
Default Lifetime(sec): 1800 (High Availability secondary is 0)
Default Preference: Medium
MTU: Auto 0
RIPng Protocol
 Enable
Extension WAN
Available WAN: [Empty]
Selected WAN: WAN3
OK Close

Router Advertisement Configuration - Click **Enable** to enable router advertisement server. The router advertisement daemon sends Router Advertisement messages, specified by RFC 2461, to a local Ethernet LAN periodically and when requested by a node sending a Router Solicitation message. These messages are required for IPv6 stateless auto-configuration.

Disable - Click it to disable router advertisement server.

Hop Limit - The value is required for the device behind the router when IPv6 is in use.

Min/Max Interval Time (sec) - It defines the interval (between minimum time and maximum time) for sending RA (Router Advertisement) packets.

Default Lifetime (sec) -Within such period of time, VigorLTE 200 can be treated as the default gateway.

Default Preference - It determines the priority of the host behind the router when RA (Router Advertisement) packets are transmitted.

MTU - It means Max Transmit Unit for packet. If **Auto** is selected, the router will determine the MTU value for LAN.

RIPng Protocol -RIPng (RIP next generation) offers the same functions and benefits as IPv4 RIP v2.

Extension WAN - In addition to the default WAN used for IPv6 traffic specified in the WAN Primary Interface in the LAN IPv6 Setup page, additional WANs can be selected to carry IPv6 traffic by enabling them in the Extension WAN section.

Available WAN - Additional WANs available but not currently selected to carry IPv6 traffic.

Selected WAN - Additional WANs selected to carry IPv6 traffic.

After making changes on the Advance setting page, click the **OK** button to retain the changes and return to the LAN IPv6 Setup page. Be sure to click **OK** on the LAN IPv6 Setup page or else changes made on the Advance setting page will not be saved.

II-3-1-5 Advanced DHCP Options

DHCP Options can be configured by clicking the **Advanced** button on the LAN General Setup screen.

LAN >> General Setup

DHCP Server Customized Status

Customized List				
Enable	Interface	Option	Type	Data

Enable:

Interface: All LAN1 LAN2 IP Routed Subnet

Next Server IP Address/SIAddr :

Option Number:

Data Type: ASCII Character (EX :Option:18, Data:/path)
 Hexadecimal Digit (EX: Option:18, Data:2f70617468)
 Address List (EX :Option:44, Data:172.16.2.10,172.16.2.20...)

Data:

Note:

1. Configuring options 44, 46 or 66 here will overwrite the settings by telnet command "msubnet".
2. Configuring option 3 here will overwrite the setting in "LAN >> General Setup" Details Page's "Gateway IP Address" field.
3. Configuring option 15 here will overwrite the setting in "WAN >> Internet Access >> Static or Dynamic IP" Detail Page's "Domain Name" field.

Available settings are explained as follows:

Item	Description
Customized List	Shows all the DHCP options that have been configured in the system.
Enable	If selected, DHCP option entry is enabled. If unselected, DHCP option entry is disabled.
Interface	LAN interface(s) to which this entry is applicable.
Next Server IP Address/SIAddr	Overrides the DHCP Next Server IP address (DHCP Option 66) supplied by the DHCP server.
Option Number	DHCP option number (e.g., 100).
Data Type	Type of data in the Data field: ASCII Character - A text string. Example: /path. Hexadecimal Digit - A hexadecimal string. Valid characters are from 0 to 9 and from a to f. Example: 2f70617468. Address List - One or more IPv4 addresses, delimited by commas.
Data	Data of this DHCP option.

To add a DHCP option entry from scratch, clear the data entry fields (**Enable**, **Interface**, **Option Number**, **Data Type** and **Data**) by clicking **Reset**. After filling in the values, click **Add** to create the new entry.

To add a DHCP option entry modeled after an existing entry, click the model entry in **Customized List**. The data entry fields will be populated with values from the model entry. After making all necessary changes for the new entry, click **Add** to create it.

To modify an existing DHCP option entry, click on it in **Customized List**. The data entry fields will be populated with the current values from the entry. After making all necessary changes, click **Update** to save the changes.

To delete a DHCP option entry, click on it in **Customized List**, and then click **Delete**.

II-3-2 VLAN

Virtual Local Area Networks (VLANs) allow you to subdivide your LAN to facilitate management or to improve network security.

Select LAN>>VLAN from the menu bar of the Web UI to bring up the VLAN Configuration page.

Tagged VLAN

The tagged VLANs (802.1q) can mark data with a VLAN identifier. This identifier can be carried through an onward Ethernet switch to specific ports. The specific VLAN clients can also pick up this identifier as it is just passed to the LAN. You can set the priorities for LAN-side QoS. You can assign each of VLANs to each of the different IP subnets that the router may also be operating, to provide even more isolation. The said functionality is **tag-based multi-subnet**.

Port-Based VLAN

Relative to tag-based VLAN which groups clients with an identifier, port-based VLAN uses physical ports (P1 ~ P2) to separate the clients into different VLAN group.

Virtual LAN function provides you a very convenient way to manage hosts by grouping them based on the physical port. The multi-subnet can let a small businesses have much better isolation for multi-occupancy applications. Go to LAN page and select VLAN. The following page will appear. Click **Enable** to invoke VLAN function.

Below is an example page in VigorLTE 200Ln:

LAN >> VLAN Configuration

VLAN Configuration

	LAN		Wireless LAN				Subnet	VLAN Tag		
	P1	P2	SSID1	SSID2	SSID3	SSID4		Enable	VID	Priority
VLAN0	<input type="checkbox"/>	<input type="checkbox"/>	<input type="checkbox"/>	<input type="checkbox"/>	<input type="checkbox"/>	<input type="checkbox"/>	LAN 1 ▾	<input type="checkbox"/>	0	0 ▾
VLAN1	<input type="checkbox"/>	<input type="checkbox"/>	<input type="checkbox"/>	<input type="checkbox"/>	<input type="checkbox"/>	<input type="checkbox"/>	LAN 1 ▾	<input type="checkbox"/>	0	0 ▾
VLAN2	<input type="checkbox"/>	<input type="checkbox"/>	<input type="checkbox"/>	<input type="checkbox"/>	<input type="checkbox"/>	<input type="checkbox"/>	LAN 1 ▾	<input type="checkbox"/>	0	0 ▾
VLAN3	<input type="checkbox"/>	<input type="checkbox"/>	<input type="checkbox"/>	<input type="checkbox"/>	<input type="checkbox"/>	<input type="checkbox"/>	LAN 1 ▾	<input type="checkbox"/>	0	0 ▾
VLAN4	<input type="checkbox"/>	<input type="checkbox"/>	<input type="checkbox"/>	<input type="checkbox"/>	<input type="checkbox"/>	<input type="checkbox"/>	LAN 1 ▾	<input type="checkbox"/>	0	0 ▾
VLAN5	<input type="checkbox"/>	<input type="checkbox"/>	<input type="checkbox"/>	<input type="checkbox"/>	<input type="checkbox"/>	<input type="checkbox"/>	LAN 1 ▾	<input type="checkbox"/>	0	0 ▾
VLAN6	<input type="checkbox"/>	<input type="checkbox"/>	<input type="checkbox"/>	<input type="checkbox"/>	<input type="checkbox"/>	<input type="checkbox"/>	LAN 1 ▾	<input type="checkbox"/>	0	0 ▾
VLAN7	<input type="checkbox"/>	<input type="checkbox"/>	<input type="checkbox"/>	<input type="checkbox"/>	<input type="checkbox"/>	<input type="checkbox"/>	LAN 1 ▾	<input type="checkbox"/>	0	0 ▾

Note:

1. For each VLAN row, selecting Enable VLAN Tag will apply the associated VID to the selected wired LAN port.
2. Wireless LAN traffic is always untagged, but the SSID is still a member of the selected VLAN (group).
3. Each VID must be unique.

OK Clear Cancel

**Info**

Settings in this page only applied to LAN port but not WAN port.

Available settings are explained as follows:

Item	Description
Enable	Click it to enable VLAN configuration.
LAN	P1 - P2 - Check the LAN port(s) to group them under the selected VLAN.
Wireless LAN	SSID1 - SSID4 - Check the SSID boxes to group them under the selected VLAN.
Subnet	Choose one of them to make the selected VLAN mapping to the specified subnet only. For example, LAN1 is specified for VLAN0. It means that PCs grouped under VLAN0 can get the IP address(es) that specified by the subnet.
VLAN Tag	<p>Enable - Check the box to enable the function of VLAN with tag.</p> <p>The router will add specific VLAN number to all packets on the LAN while sending them out.</p> <p>Please Enter the tag value and specify the priority for the packets sending by LAN.</p> <p>VID - Enter the value as the VLAN ID number. The range is form 0 to 4095. VIDs must be unique.</p> <p>Priority - Valid values are from 0 to 7, where 1 has the lowest priority, followed by 0, and finally from 2 to 7 in increasing order of priority.</p>

**Info**

Leave one VLAN untagged at least to prevent from not connecting to Vigor router due to unexpected error.

The Vigor router supports up to 8 VLANs. Each VLAN can be set up to use one or more of the Ethernet ports and wireless LAN Service Set Identifiers (SSIDs). Within the grid of VLANs (horizontal rows) and LAN interfaces (vertical columns),

- all hosts within the same VLAN (horizontal row) are visible to one another
- all hosts connected to the same LAN or WLAN interface (vertical column) are visible to one another if
 - they belong to the same VLAN, or
 - they belong to different VLANs, and inter-LAN routing (LAN>>General Setup) between them is enabled (see below).

Force router to use "DNS server IP address" settings specified in LAN1 ▾

Inter-LAN Routing

Subnet	LAN 1	LAN 2
LAN 1	<input checked="" type="checkbox"/>	<input type="checkbox"/>
LAN 2	<input type="checkbox"/>	<input checked="" type="checkbox"/>

Inter-LAN Routing allows different LAN subnets to be interconnected or isolated. It is only available when the VLAN functionality is enabled. In the Inter-LAN Routing matrix, a selected checkbox means that the 2 intersecting LANs can communicate with each other.

VigorLTE 200 series features a hugely flexible VLAN system. In its simplest form, each of the Gigabit LAN ports can be isolated from each other, for example to feed different companies or departments but keeping their local traffic completely separated.

Configuring port-based VLAN for wireless and non-wireless clients

1. All the wire network clients are categorized to group VLAN0 in subnet 192.168.1.0/24 (LAN1).
2. All the wireless network clients are categorized to group VLAN1 in subnet 192.168.2.0/24 (LAN2).
3. Open LAN>>VLAN. Check the boxes according to the statement in step 1 and Step 2.

LAN >> VLAN Configuration

VLAN Configuration

	LAN		Wireless LAN				Subnet	VLAN Tag		
	P1	P2	SSID1	SSID2	SSID3	SSID4		Enable	VID	Priority
VLAN0	<input checked="" type="checkbox"/>	<input checked="" type="checkbox"/>	<input type="checkbox"/>	<input type="checkbox"/>	<input type="checkbox"/>	<input type="checkbox"/>	LAN 1 ▾	<input type="checkbox"/>	0	0 ▾
VLAN1	<input type="checkbox"/>	<input type="checkbox"/>	<input checked="" type="checkbox"/>	<input checked="" type="checkbox"/>	<input checked="" type="checkbox"/>	<input checked="" type="checkbox"/>	LAN 2 ▾	<input type="checkbox"/>	0	0 ▾
VLAN2	<input type="checkbox"/>	<input type="checkbox"/>	<input type="checkbox"/>	<input type="checkbox"/>	<input type="checkbox"/>	<input type="checkbox"/>	LAN 1 ▾	<input type="checkbox"/>	0	0 ▾
VLAN3	<input type="checkbox"/>	<input type="checkbox"/>	<input type="checkbox"/>	<input type="checkbox"/>	<input type="checkbox"/>	<input type="checkbox"/>	LAN 1 ▾	<input type="checkbox"/>	0	0 ▾
VLAN4	<input type="checkbox"/>	<input type="checkbox"/>	<input type="checkbox"/>	<input type="checkbox"/>	<input type="checkbox"/>	<input type="checkbox"/>	LAN 1 ▾	<input type="checkbox"/>	0	0 ▾
VLAN5	<input type="checkbox"/>	<input type="checkbox"/>	<input type="checkbox"/>	<input type="checkbox"/>	<input type="checkbox"/>	<input type="checkbox"/>	LAN 1 ▾	<input type="checkbox"/>	0	0 ▾
VLAN6	<input type="checkbox"/>	<input type="checkbox"/>	<input type="checkbox"/>	<input type="checkbox"/>	<input type="checkbox"/>	<input type="checkbox"/>	LAN 1 ▾	<input type="checkbox"/>	0	0 ▾
VLAN7	<input type="checkbox"/>	<input type="checkbox"/>	<input type="checkbox"/>	<input type="checkbox"/>	<input type="checkbox"/>	<input type="checkbox"/>	LAN 1 ▾	<input type="checkbox"/>	0	0 ▾

Note:

1. For each VLAN row, selecting Enable VLAN Tag will apply the associated VID to the selected wired LAN port.
2. Wireless LAN traffic is always untagged, but the SSID is still a member of the selected VLAN (group).
3. Each VID must be unique.

4. Click OK.
5. Open LAN>>General Setup. If you want to let the clients in both groups communicate with each other, simply activate Inter-LAN Routing by checking the box between LAN1 and LAN2.

LAN >> General Setup

General Setup

Index	Enable	DHCP	DHCPv6	IP Address		
LAN 1	<input checked="" type="checkbox"/>	<input checked="" type="checkbox"/>	<input checked="" type="checkbox"/>	192.168.1.1	Details Page	IPv6
LAN 2	<input type="checkbox"/>	<input checked="" type="checkbox"/>	<input checked="" type="checkbox"/>	192.168.2.1	Details Page	IPv6
IP Routed Subnet	<input type="checkbox"/>	<input checked="" type="checkbox"/>		192.168.0.1	Details Page	

[DHCP Server Option](#)

Note:

Please enable LAN 2 on [LAN >> VLAN](#) page before configure them.

Force router to use "DNS server IP address" settings specified in [LAN1](#) ▾

Inter-LAN Routing

Subnet	LAN 1	LAN 2
LAN 1	<input checked="" type="checkbox"/>	<input type="checkbox"/>
LAN 2	<input checked="" type="checkbox"/>	<input checked="" type="checkbox"/>

[OK](#)

Vigor router supports up to six private IP subnets on LAN. Each can be independent (isolated) or common (able to communicate with each other). This is ideal for departmental or multi-occupancy applications.



Info

As for the VLAN applications, refer to "Appendix I: VLAN Application on Vigor Router" for more detailed information.

II-3-3 Bind IP to MAC

This function is used to bind the IP and MAC address in LAN to have a strengthening control in network. With the Bind IP to MAC feature you can reserve LAN IP addresses for LAN clients. Each reserved IP address is associated with a Media Access Control (MAC) address.

Click [LAN](#) and click [Bind IP to MAC](#) to open the setup page.

Bind IP to MAC

Enable Disable
 Strict Bind

Apply Strict Bind to Subnet:

ARP Table | [Select All](#) | [Sort](#) | [Refresh](#) | [Add/Update to IP Bind List](#)

IP Address	Mac Address	HOST ID
192.168.1.5	60-A4-4C-E6-5A-4F	

IP Address:
 Mac Address: :::::
 Comment: (Max: 12 characters)

IP Bind List (Limit: 300 entries) | [Select All](#) | [Sort](#) |

Index	IP Address	Mac Address	Host ID	Comment
-------	------------	-------------	---------	---------

Backup IP Bind List : Upload From File: 未選擇任何檔案

Note:

1. IP-MAC binding presets DHCP Allocations.
2. If Strict Bind is enabled, unspecified LAN clients in the selected subnets cannot access the Internet.
3. Comment can not contain characters " and '.

Available settings are explained as follows:

Item	Description
Enable	Click this radio button to invoke this function. However, IP/MAC which is not listed in IP Bind List also can connect to Internet.
Disable	Click this radio button to disable this function. All the settings on this page will be invalid.
Strict Bind	Check the box to block the connection of the IP/MAC which is not listed in IP Bind List. LAN clients will be assigned IP addresses according to the MAC-to-IP address associations on this page. LAN client whose MAC address has not been bound to an IP address will be denied network access. Note: Before selecting Strict Bind , make sure at least one valid MAC address has been bound to an IP address. Otherwise no LAN clients will have network access, and it will not be possible to connect to the router to make changes to its configuration.

	<p>Apply Strict Bind to Subnet – Choose the subnet(s) for applying the rules of Bind IP to MAC.</p> <p>Apply Strict Bind to Subnet:</p> <p>Select All Clear All</p> <table border="1"> <thead> <tr> <th>Subnet</th> <th>IP Address</th> </tr> </thead> <tbody> <tr> <td><input type="checkbox"/> LAN1</td> <td>192.168.1.1</td> </tr> <tr> <td><input type="checkbox"/> LAN2</td> <td>192.168.2.1</td> </tr> <tr> <td><input type="checkbox"/> IP Routed Subnet</td> <td>192.168.0.1</td> </tr> </tbody> </table> <p>OK Close</p>	Subnet	IP Address	<input type="checkbox"/> LAN1	192.168.1.1	<input type="checkbox"/> LAN2	192.168.2.1	<input type="checkbox"/> IP Routed Subnet	192.168.0.1
Subnet	IP Address								
<input type="checkbox"/> LAN1	192.168.1.1								
<input type="checkbox"/> LAN2	192.168.2.1								
<input type="checkbox"/> IP Routed Subnet	192.168.0.1								
ARP Table	This table is the LAN ARP table of this router. The information for IP and MAC will be displayed in this field. Each pair of IP and MAC address listed in ARP table can be selected and added to IP Bind List by clicking Add below.								
Select All	Select all entries in the ARP Table for manipulation.								
Sort	Reorder the entry based on the IP address.								
Refresh	Refresh the ARP table listed below to obtain the newest ARP table information.								
Add / Update to IP Bind List	<p>IP Address – Enter the IP address to be associated with a MAC address.</p> <p>Mac Address – Enter the MAC address of the LAN client’s network interface.</p> <p>Comment – Type a brief description for the entry.</p> <p>Add - It allows you to add the one you choose from the ARP table or the IP/MAC address typed in Add and Edit to the table of IP Bind List.</p> <p>Update - It allows you to edit and modify the selected IP address and MAC address that you create before.</p> <p>Delete - You can remove any item listed in IP Bind List. Simply click and select the one, and click Delete. The selected item will be removed from the IP Bind List.</p>								
IP Bind List	It displays a list for the IP bind to MAC information.								
Backup IP Bind List	Click Backup and enter a filename to back up IP Bind List to a file.								
Upload From File	Click Browse... to select an IP Bind List backup file. Click Restore to restore the backup and overwrite the existing list.								



Info

Before you select Strict Bind, you have to bind one set of IP/MAC address for one PC. If not, no one of the PCs can access into Internet. And the web user interface of the router might not be accessed.

When you finish the configuration, click **OK** to save the settings.

II-4 NAT

Usually, the router serves as an NAT (Network Address Translation) router. NAT is a mechanism that one or more private IP addresses can be mapped into a single public one. Public IP address is usually assigned by your ISP, for which you may get charged. Private IP addresses are recognized only among internal hosts.

When the outgoing packets destined to some public server on the Internet reach the NAT router, the router will change its source address into the public IP address of the router, select the available public port, and then forward it. At the same time, the router shall list an entry in a table to memorize this address/port-mapping relationship. When the public server response, the incoming traffic, of course, is destined to the router's public IP address and the router will do the inversion based on its table. Therefore, the internal host can communicate with external host smoothly.

The benefit of the NAT includes:

- **Save cost on applying public IP address and apply efficient usage of IP address.** NAT allows the internal IP addresses of local hosts to be translated into one public IP address, thus you can have only one IP address on behalf of the entire internal hosts.
- **Enhance security of the internal network by obscuring the IP address.** There are many attacks aiming victims based on the IP address. Since the attacker cannot be aware of any private IP addresses, the NAT function can protect the internal network.



Info

On NAT page, you will see the private IP address defined in RFC-1918. Usually we use the 192.168.1.0/24 subnet for the router. As stated before, the NAT facility can map one or more IP addresses and/or service ports into different specified services. In other words, the NAT function can be achieved by using port mapping methods.

Web User Interface

Routing
NAT
Port Redirection
DMZ Host
Open Ports
ALG

II-4-1 Port Redirection

Port Redirection is usually set up for server related service inside the local network (LAN), such as web servers, FTP servers, E-mail servers etc. Most of the case, you need a public IP address for each server and this public IP address/domain name are recognized by all users. Since the server is actually located inside the LAN, the network well protected by NAT of the router, and identified by its private IP address/port, the goal of Port Redirection function is to forward all access request with public IP address from external users to the mapping private IP address/port of the server.

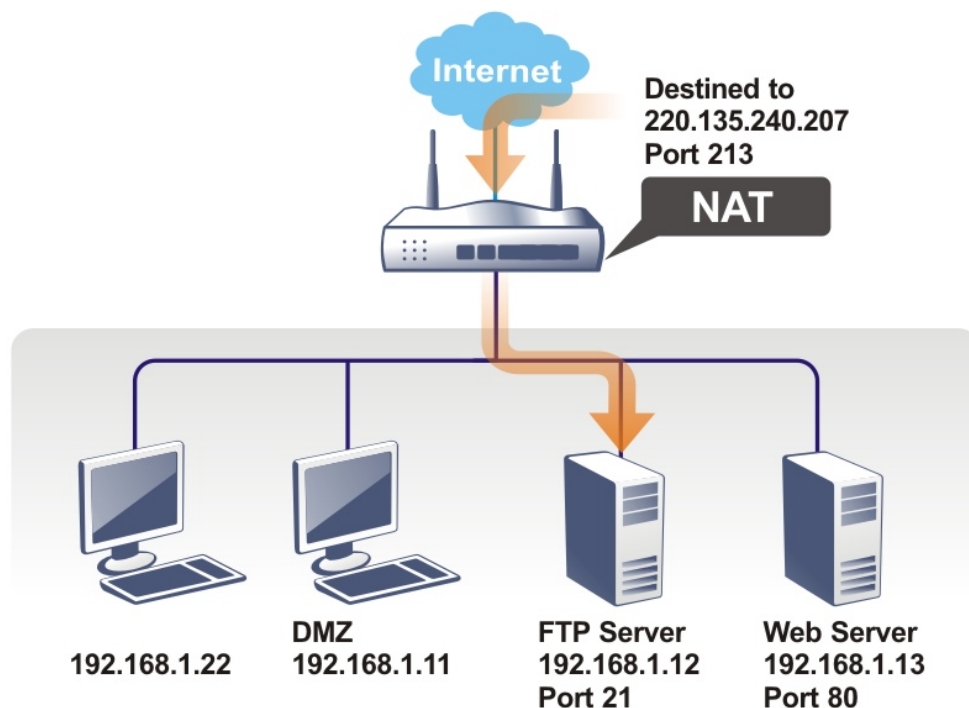

The port redirection can only apply to incoming traffic.

To use this function, please go to NAT page and choose Port Redirection web page. The Port Redirection Table provides 40 port-mapping entries for the internal hosts.

Port Redirection | [Set to Factory Default](#) |

Index	Enable	Service Name	WAN Interface	Protocol	Public Port	Source IP	Private IP
<u>1.</u>	<input type="checkbox"/>		All			Any	
<u>2.</u>	<input type="checkbox"/>		All			Any	
<u>3.</u>	<input type="checkbox"/>		All			Any	
<u>4.</u>	<input type="checkbox"/>		All			Any	
<u>5.</u>	<input type="checkbox"/>		All			Any	
<u>6.</u>	<input type="checkbox"/>		All			Any	
<u>7.</u>	<input type="checkbox"/>		All			Any	
<u>8.</u>	<input type="checkbox"/>		All			Any	
<u>9.</u>	<input type="checkbox"/>		All			Any	
<u>10.</u>	<input type="checkbox"/>		All			Any	

<< [1-10](#) | [11-20](#) >> [Next](#) >>

Note:
 The port number values set in this page might be invalid due to the same values configured for Management Port Setup in [System Maintenance>>Management](#) and [SSL VPN](#).

Each item is explained as follows:

Item	Description
Index	Display the number of the profile.
Enable	Check the box to enable the profile.
Service Name	Display the description of the specific network service.
WAN Interface	Display the WAN IP address used by the profile.
Protocol	Display the transport layer protocol (TCP or UDP).
Public Port	Display the port number which will be redirected to the specified Private IP and Port of the internal host.
Source IP	Display the source IP address or object.
Private IP	Display the IP address of the internal host providing the service.

Press any number under Index to access into next page for configuring port redirection.

NAT >> Port Redirection

Index No. 1

<input type="checkbox"/> Enable	
Mode	Single ▾
Service Name	Single <input type="text"/>
Protocol	TCP ▾
WAN Interface	ALL ▾
Public Port	0 <input type="text"/>
Source IP	Any ▾ IP Object
Private IP	<input type="text"/>
Private Port	0 <input type="text"/>

Note:

In "Range" Mode the End IP will be calculated automatically once the Public Port and Start IP have been entered.

OK Clear Cancel

Available settings are explained as follows:

Item	Description
Enable	Check this box to enable such port redirection setting.
Mode	Two options (Single and Range) are provided here for you to choose. To set a range for the specific service, select Range . In Range mode, if the public port (start port and end port) and the starting IP of private IP had been entered, the system will calculate and display the ending IP of private IP automatically.
Service Name	Enter the description of the specific network service.
Protocol	Select the transport layer protocol (TCP or UDP).
WAN Interface	Select the WAN IP used for port redirection. There are eight WAN IP alias that can be selected and used for port redirection. The default setting is All which means all the incoming data from any port will be redirected to all interfaces.
Public Port	Specify which port can be redirected to the specified Private IP and Port of the internal host. If you choose Range as the port redirection mode, you will see two boxes on this field. Enter the required number on the first box (as the starting port) and the second box (as the ending port).
Source IP	Use the drop down list to specify an IP object. Or click IP Object link to create a new one for applying.
Private IP	Specify the private IP address of the internal host providing the service. If you choose Range as the port redirection mode, you will see two boxes on this field. Type a complete IP address in the first box (as the starting point). The second one will be assigned automatically later.
Private Port	Specify the private port number of the service offered by the internal host.

After finishing all the settings here, please click **OK** to save the configuration.

Note that the router has its own built-in services (servers) such as Telnet, HTTP and FTP etc. Since the common port numbers of these services (servers) are all the same, you may need to reset the router in order to avoid confliction.

For example, the built-in web user interface in the router is with default port 80, which may conflict with the web server in the local network, http://192.168.1.13:80. Therefore, you need to **change the router's http port to any one other than the default port 80** to avoid conflict, such as 8080. This can be set in the **System Maintenance >>Management Setup**. You then will access the admin screen of by suffixing the IP address with 8080, e.g., http://192.168.1.1:8080 instead of port 80.

System Maintenance >> Management



IPv4 Management Setup	IPv6 Management Setup	LAN Access Setup									
Router Name <input type="text" value="DrayTek"/>											
<input type="checkbox"/> Default:Disable Auto-Logout <hr/> Internet Access Control <input type="checkbox"/> Allow management from the Internet Domain name allowed <input type="text"/> <input type="checkbox"/> FTP Server <input type="checkbox"/> HTTP Server <input checked="" type="checkbox"/> HTTPS Server <input type="checkbox"/> Telnet Server <input type="checkbox"/> TR069 Server <input type="checkbox"/> SSH Server <input checked="" type="checkbox"/> Disable PING from the Internet <hr/> Access List from the Internet <table border="1"> <thead> <tr> <th>List</th> <th>index in IP Object</th> <th>IP / Mask</th> </tr> </thead> <tbody> <tr> <td>1</td> <td><input type="text"/></td> <td><input type="text"/></td> </tr> <tr> <td>2</td> <td><input type="text"/></td> <td><input type="text"/></td> </tr> </tbody> </table>	List	index in IP Object	IP / Mask	1	<input type="text"/>	<input type="text"/>	2	<input type="text"/>	<input type="text"/>	Management Port Setup <input checked="" type="radio"/> User Define Ports <input type="radio"/> Default Ports Telnet Port <input type="text" value="23"/> (Default: 23) HTTP Port <input type="text" value="80"/> (Default: 80) HTTPS Port <input type="text" value="443"/> (Default: 443) FTP Port <input type="text" value="21"/> (Default: 21) TR069 Port <input type="text" value="8069"/> (Default: 8069) SSH Port <input type="text" value="22"/> (Default: 22) <hr/> TLS/SSL Encryption Setup <input checked="" type="checkbox"/> Enable TLS 1.2 <input checked="" type="checkbox"/> Enable TLS 1.1 <input checked="" type="checkbox"/> Enable TLS 1.0 <input type="checkbox"/> Enable SSL 3.0 <hr/> <input checked="" type="checkbox"/> Device Management <input type="checkbox"/> Respond to external device	
List	index in IP Object	IP / Mask									
1	<input type="text"/>	<input type="text"/>									
2	<input type="text"/>	<input type="text"/>									

II-4-2 DMZ Host

As mentioned above, **Port Redirection** can redirect incoming TCP/UDP or other traffic on particular ports to the specific private IP address/port of host in the LAN. However, other IP protocols, for example Protocols 50 (ESP) and 51 (AH), do not travel on a fixed port. Vigor router provides a facility **DMZ Host** that maps ALL unsolicited data on any protocol to a single host in the LAN. Regular web surfing and other such Internet activities from other clients will continue to work without inappropriate interruption. **DMZ Host** allows a defined internal user to be totally exposed to the Internet, which usually helps some special applications such as Netmeeting or Internet Games etc.

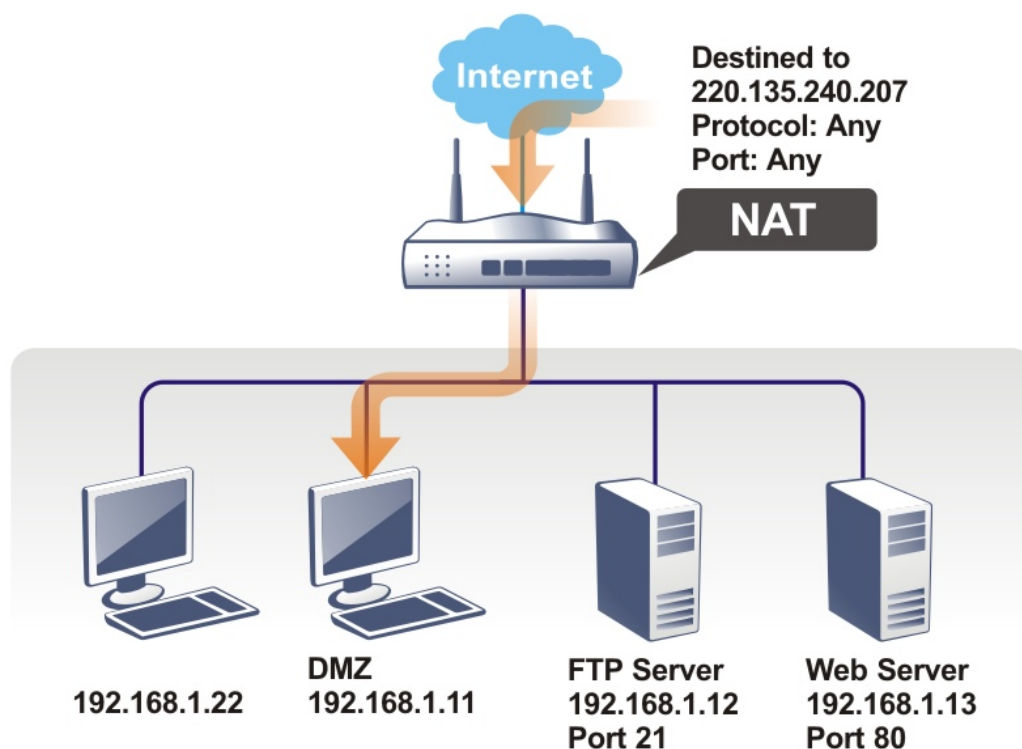

The security properties of NAT are somewhat bypassed if you set up DMZ host. We suggest you to add additional filter rules or a secondary firewall.

Click **DMZ Host** to open the following page. You can set different DMZ host for each WAN interface. Click the WAN tab to switch into the configuration page for that WAN.

NAT >> DMZ Host Setup

DMZ Host Setup

WAN2
LTE

WAN 2

Enable

Private IP

Available settings are explained as follows:

Item	Description
Enable	Check the box to enable the DMZ function.
Private IP	Enter the private IP address of the DMZ host, or click Choose IP to select one.

Choose IP

Click this button and then a window will automatically pop up, as depicted below. The window consists of a list of private IP addresses of all hosts in your LAN network. Select one private IP address in the list to be the DMZ host.

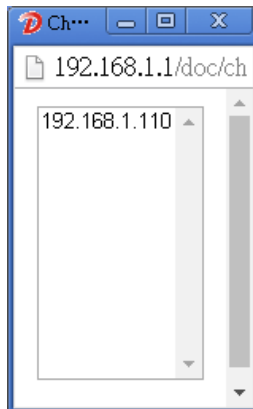

When you have selected one private IP from the above dialog, the IP address will be shown on the screen. Click OK to save the setting.

If you previously have set up WAN Alias for PPPoE or Static or Dynamic IP mode in WAN interface, you will find them in Aux. WAN IP for your selection.

NAT >> DMZ Host Setup

DMZ Host Setup

WAN2				LTE	
Index	Enable	Aux. WAN IP	Private IP		
1.	<input type="checkbox"/>	---	0.0.0.0	Choose IP	
2.	<input type="checkbox"/>	192.168.1.89	0.0.0.0	Choose IP	

OK Clear

Available settings are explained as follows:

Item	Description
Enable	Check to enable the DMZ Host function.
Private IP	Enter the private IP address of the DMZ host, or click Choose IP to select one.
Choose IP	Click this button and then a window will automatically pop up, as depicted below. The window consists of a list of private IP addresses of all hosts in your LAN network. Select one private IP address in the list to be the DMZ host.

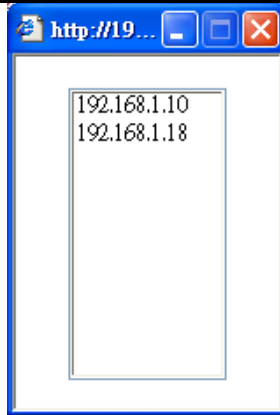

When you have selected one private IP from the above dialog, the IP address will be shown on the screen. Click **OK** to save the setting.

After finishing all the settings here, please click **OK** to save the configuration.

II-4-3 Open Ports

Open Ports allows you to open a range of ports for the traffic of special applications.

Common application of Open Ports includes P2P application (e.g., BT, KaZaA, Gnutella, WinMX, eMule and others), Internet Camera etc. Ensure that you keep the application involved up-to-date to avoid falling victim to any security exploits.

Click **Open Ports** to open the following page:

NAT >> Open Ports

Open Ports Setup						Set to Factory Default
Index	Enable	Comment	Aux. WAN IP	Source IP	Local IP Address	
<u>1.</u>	<input type="checkbox"/>			Any		
<u>2.</u>	<input type="checkbox"/>			Any		
<u>3.</u>	<input type="checkbox"/>			Any		
<u>4.</u>	<input type="checkbox"/>			Any		
<u>5.</u>	<input type="checkbox"/>			Any		
<u>6.</u>	<input type="checkbox"/>			Any		
<u>7.</u>	<input type="checkbox"/>			Any		
<u>8.</u>	<input type="checkbox"/>			Any		
<u>9.</u>	<input type="checkbox"/>			Any		
<u>10.</u>	<input type="checkbox"/>			Any		

<< [1-10](#) | [11-20](#) >> [Next](#) >>

Note:

The port number values set in this page might be invalid due to the same values configured for Management Port Setup in [System Maintenance>>Management](#) and [SSL VPN](#).

Available settings are explained as follows:

Item	Description
Index	Indicate the relative number for the particular entry that you want to offer service in a local host. You should click the appropriate index number to edit or clear the corresponding entry.
Enable	Check the box to enable the open port profile.
Comment	Specify the name for the defined network service.
WAN Interface	Display the WAN interface used by such index.
Aux. WAN IP	Display the IP alias setting used by such index. If no IP alias setting exists, such field will not appear.
Source IP	Display the name of source IP object.
Local IP Address	Display the private IP address of the local host offering the service.

To add or edit port settings, click one index number on the page. The index entry setup page will pop up. In each index entry, you can specify 10 port ranges for diverse services.

Index No. 1

<input checked="" type="checkbox"/> Enable Open Ports							
Comment		<input type="text" value="TEST"/>					
Source IP		Any ▾ IP Object					
Private IP		<input type="text" value="192.168.1.5"/>	<input type="button" value="Choose IP"/>				
	Protocol	Start Port	End Port		Protocol	Start Port	End Port
1.	TCP/UDP ▾	<input type="text" value="0"/>	<input type="text" value="0"/>	2.	TCP/UDP ▾	<input type="text" value="0"/>	<input type="text" value="0"/>
3.	TCP/UDP ▾	<input type="text" value="0"/>	<input type="text" value="0"/>	4.	TCP/UDP ▾	<input type="text" value="0"/>	<input type="text" value="0"/>
5.	TCP/UDP ▾	<input type="text" value="0"/>	<input type="text" value="0"/>	6.	TCP/UDP ▾	<input type="text" value="0"/>	<input type="text" value="0"/>
7.	TCP/UDP ▾	<input type="text" value="0"/>	<input type="text" value="0"/>	8.	TCP/UDP ▾	<input type="text" value="0"/>	<input type="text" value="0"/>
9.	TCP/UDP ▾	<input type="text" value="0"/>	<input type="text" value="0"/>	10.	TCP/UDP ▾	<input type="text" value="0"/>	<input type="text" value="0"/>

Available settings are explained as follows:

Item	Description
Enable Open Ports	Check to enable this entry.
Comment	Make a name for the defined network application/service.
Source IP	Use the drop down list to specify an IP object. Or click IP Object link to create a new one for applying.
Private IP	Enter the private IP address of the local host or click Choose IP to select one. Choose IP - Click this button and, subsequently, a window having a list of private IP addresses of local hosts will automatically pop up. Select the appropriate IP address of the local host in the list.
Protocol	Specify the transport layer protocol. It could be TCP, UDP, or ----- (none) for selection.
Start Port	Specify the starting port number of the service offered by the local host.
End Port	Specify the ending port number of the service offered by the local host.

After finishing all the settings here, please click OK to save the configuration.

NAT >> Open Ports

Open Ports Setup | [Set to Factory Default](#) |

Index	Enable	Comment	Aux. WAN IP	Source IP	Local IP Address
1.	<input checked="" type="checkbox"/>	TEST		Any	192.168.1.5
2.	<input type="checkbox"/>			Any	
3.	<input type="checkbox"/>			Any	
4.	<input type="checkbox"/>			Any	
5.	<input type="checkbox"/>			Any	
6.	<input type="checkbox"/>			Any	
7.	<input type="checkbox"/>			Any	
8.	<input type="checkbox"/>			Any	
9.	<input type="checkbox"/>			Any	
10.	<input type="checkbox"/>			Any	

<< 1-10 | **11-20** >> [Next](#) >>

Note:

The port number values set in this page might be invalid due to the same values configured for Management Port Setup in [System Maintenance>>Management](#) and [SSL VPN](#).

II-4-4 ALG

ALG means **Application Layer Gateway**. There are two methods provided by Vigor router, RTSP (Real Time Streaming Protocol) ALG and SIP (Session Initiation Protocol) ALG, for processing the packets of voice and video.

RTSP ALG makes RTSP message, RTCP message, and RTP packets of voice and video be transmitted and received correctly via NAT by Vigor router.

However, SIP ALG makes SIP message and RTP packets of voice be transmitted and received correctly via NAT by Vigor router.

NAT >> ALG

ALG (Application Layer Gateway) | [Set to Factory Default](#) |

Enable ALG

<input type="checkbox"/> Enable	Protocol	Listen Port	TCP	UDP
<input type="checkbox"/>	SIP	5060 (1~65535)	<input checked="" type="checkbox"/>	<input checked="" type="checkbox"/>
<input type="checkbox"/>	RTSP	554 (1~65535)	<input checked="" type="checkbox"/>	<input checked="" type="checkbox"/>

Available settings are explained as follows:

Item	Description
Enable ALG	Check to enable such function.
Listen Port	Type a port number for SIP or RTSP protocol.

TCP	Check the box to make correspond protocol message packet from TCP transmit and receive via NAT.
UDP	Check the box to make correspond protocol message packet from UDP transmit and receive via NAT.

II-5 Applications

Dynamic DNS

The ISP often provides you with a dynamic IP address when you connect to the Internet via your ISP. It means that the public IP address assigned to your router changes each time you access the Internet. The Dynamic DNS feature lets you assign a domain name to a dynamic WAN IP address. It allows the router to update its online WAN IP address mappings on the specified Dynamic DNS server. Once the router is online, you will be able to use the registered domain name to access the router or internal virtual servers from the Internet. It is particularly helpful if you host a web server, FTP server, or other server behind the router.

Before you use the Dynamic DNS feature, you have to apply for free DDNS service to the DDNS service providers. The router provides up to three accounts from three different DDNS service providers. Basically, Vigor routers are compatible with the DDNS services supplied by most popular DDNS service providers such as www.dyndns.org, www.no-ip.com, www.dtdns.com, www.changeip.com, www.dynamic-nameserver.com. You should visit their websites to register your own domain name for the router.

Schedule

The Vigor router has a built-in clock which can update itself manually or automatically by means of Network Time Protocols (NTP). As a result, you can not only schedule the router to dialup to the Internet at a specified time, but also restrict Internet access to certain hours so that users can connect to the Internet only during certain hours, say, business hours. The schedule is also applicable to other functions.

RADIUS

Remote Authentication Dial-In User Service (RADIUS) is a security authentication client/server protocol that supports authentication, authorization and accounting, which is widely used by Internet service providers. It is the most common method of authenticating and authorizing dial-up and tunneled network users.

The built-in RADIUS client feature enables the router to assist the remote dial-in user or a wireless station and the RADIUS server in performing mutual authentication. It enables centralized remote access authentication for network management.

UPnP

The UPnP (Universal Plug and Play) protocol is supported to bring to network connected devices the ease of installation and configuration which is already available for directly connected PC peripherals with the existing Windows 'Plug and Play' system. For NAT routers, the major feature of UPnP on the router is "NAT Traversal". This enables applications inside the firewall to automatically open the ports that they need to pass through a router.

Web User Interface

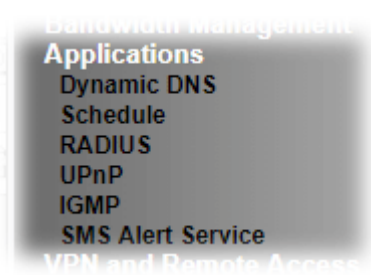

II-5-1 Dynamic DNS

Enable the Function and Add a Dynamic DNS Account

1. Assume you have a registered domain name from the DDNS provider, say *hostname.dyndns.org*, and an account with username: *test* and password: *test*.
2. Open **Applications>>Dynamic DNS**.
3. In the DDNS setup menu, check **Enable Dynamic DNS Setup**.

Applications >> Dynamic DNS Setup

| [Set to Factory Default](#) |

Enable Dynamic DNS Setup [View Log](#) [Force Update](#)

Auto-Update interval Min(s) (180~14400)

Accounts:

Index	Enable	Domain Name
1.	<input type="checkbox"/>	
2.	<input type="checkbox"/>	
3.	<input type="checkbox"/>	
4.	<input type="checkbox"/>	
5.	<input type="checkbox"/>	
6.	<input type="checkbox"/>	

[OK](#) [Clear All](#)

Available settings are explained as follows:

Item	Description
Enable Dynamic DNS Setup	Check this box to enable DDNS function.
Set to Factory Default	Clear all profiles and recover to factory settings.
View Log	Display DDNS log status.
Force Update	Force the router updates its information to DDNS server.
Auto-Update interval	Set the time for the router to perform auto update for DDNS service.
Index	Click the number below Index to access into the setting page of DDNS setup to set account(s).

Enable	Check the box to enable this account.
Domain Name	Display the domain name that you set on the setting page of DDNS setup.

4. Select Index number 1 to add an account for the router. Check **Enable Dynamic DNS Account**, and choose correct Service Provider: *dyndns.org*, Enter the registered hostname: *hostname* and domain name suffix: *dyndns.org* in the **Domain Name** block. The following two blocks should be typed your account Login Name: *test* and Password: *test*.

Applications >> Dynamic DNS Setup >> Dynamic DNS Account Setup

Index : 1

Enable Dynamic DNS Account
 WAN Interface: WAN1 First
 Service Provider: dyn.com (www.dyn.com)
 Service Type: Dynamic
 Domain Name: chronic5563 .dyndns.org dyndns.org
 Login Name: chronic5563
 Password:
 Wildcards

 Mail Extender:
 Determine WAN IP: WAN IP

If **User-Defined** is specified as the service provider, the web page will be changed slightly as follows:

Applications >> Dynamic DNS Setup >> Dynamic DNS Account Setup

Index : 1

Enable Dynamic DNS Account
 WAN Interface: WAN1 First
 Service Provider: User-Defined
 Provider Host: changeip.org
 Service API: /dynamic/dns/update.asp?u=jo***&p=jo*****&hostname=j****.changeip.org&ip=##IP##&cmd=update&offline=0
 Auth Type: basic
 Connection Type: Http
 Server Response:
 Login Name: chronic5563 (max. 64 characters)
 Password: (max. 64 characters)
 Wildcards

 Mail Extender:
 Determine WAN IP: WAN IP

Available settings are explained as follows:

Item	Description
------	-------------

Enable Dynamic DNS Account	Check this box to enable the current account. If you did check the box, you will see a check mark appeared on the Active column of the previous web page in step 2).
Service Provider	Select the service provider for the DDNS account.
Provider Host	Enter the IP address or the domain name of the host which provides related service. Note that such option is available when Customized is selected as Service Provider.
Service API	Enter the API information obtained from DDNS server. Note that such option is available when Customized is selected as Service Provider. (e.g: /dynamic/dns/update.asp?u=jo***&p=jo*****&hostname=j***.changeip.org&ip=###IP### &cmd=update&offline=0)
Auth Type	Two types can be used for authentication. Basic - Username and password defined later can be shown from the packets captured. URL - Username and password defined later can be shown in URL. (e.g. , http://ns1.vigorddns.com/ddns.php?username=xxxx&password=xxxx&domain=xxxx.vigorddns.com) Note that such option is available when Customized is selected as Service Provider.
Connection Type	There are two connection types (HTTP and HTTPS) to be specified. Note that such option is available when Customized is selected as Service Provider.
Server Response	Type any text that you want to receive from the DDNS server. Note that such option is available when Customized is selected as Service Provider.
Login Name	Enter the login name that you set for applying domain.
Password	Enter the password that you set for applying domain.
Wildcard	The Wildcard feature is not supported for all Dynamic DNS providers. You could get more detailed information from their websites.
Mail Extender	If the mail server is defined with another name, please Enter the name in this area. Such mail server will be used as backup mail exchange.
Determine WAN IP	If a Vigor router is installed behind any NAT router, you can enable such function to locate the real WAN IP. When the WAN IP used by Vigor router is private IP, this function can detect the public IP used by the NAT router and use the detected IP address for DDNS update. There are two methods offered for you to choose: <ul style="list-style-type: none"> ● WAN IP - If it is selected and the WAN IP of Vigor router is private, DDNS update will take place right away. ● Internet IP - If it is selected and the WAN IP of Vigor router is private, it will be converted to public IP before DDNS update takes place.

5. Click OK button to activate the settings. You will see your setting has been saved.

Disable the Function and Clear all Dynamic DNS Accounts

Uncheck **Enable Dynamic DNS Setup**, and click **Clear All** button to disable the function and clear all accounts from the router.

II-5-2 Schedule

The Vigor router has a built-in clock which can update itself manually or automatically by means of Network Time Protocols (NTP). As a result, you can not only schedule the router to dialup to the Internet at a specified time, but also restrict Internet access to certain hours so that users can connect to the Internet only during certain hours, say, business hours. The schedule is also applicable to other functions.

You have to set your time before set schedule. In **System Maintenance>> Time and Date** menu, press **Inquire Time** button to set the Vigor router's clock to current time of your PC. The clock will reset once if you power down or reset the router. There is another way to set up time. You can inquiry an NTP server (a time server) on the Internet to synchronize the router's clock. This method can only be applied when the WAN connection has been built up.

Applications >> Schedule

Schedule: | [Set to Factory Default](#) |

Index	Enable	Comment	Index	Enable	Comment
1.	<input type="checkbox"/>		9.	<input type="checkbox"/>	
2.	<input type="checkbox"/>		10.	<input type="checkbox"/>	
3.	<input type="checkbox"/>		11.	<input type="checkbox"/>	
4.	<input type="checkbox"/>		12.	<input type="checkbox"/>	
5.	<input type="checkbox"/>		13.	<input type="checkbox"/>	
6.	<input type="checkbox"/>		14.	<input type="checkbox"/>	
7.	<input type="checkbox"/>		15.	<input type="checkbox"/>	
8.	<input type="checkbox"/>				

Available settings are explained as follows:

Item	Description
Set to Factory Default	Clear all profiles and recover to factory settings.
Index	Click the index number link to access into the setting page of schedule.
Enable	Click the box to enable such schedule profile.
Comment	Display the name of the time schedule.

You can set up to 15 schedules. Then you can apply them to your **Internet Access** or **VPN and Remote Access >> LAN to LAN** settings.

To add a schedule:

1. Click any index, say Index No. 1.
2. The detailed settings of the schedule with index 1 will be shown below.

Index No. 1

<input checked="" type="checkbox"/> Enable Schedule Setup	
Comment	<input type="text"/>
Start Date (yyyy-mm-dd)	2000 ▾ - 1 ▾ - 1 ▾
Start Time (hh:mm)	0 ▾ : 0 ▾
Duration Time (hh:mm)	0 ▾ : 0 ▾
Action	Force On ▾
Idle Timeout	0 <input type="text"/> minute(s).(max. 255, 0 for default)
How Often	
<input type="radio"/> Once	
<input checked="" type="radio"/> Weekdays	
<input type="checkbox"/> Sun	<input checked="" type="checkbox"/> Mon
<input checked="" type="checkbox"/> Tue	<input checked="" type="checkbox"/> Wed
<input checked="" type="checkbox"/> Thu	<input checked="" type="checkbox"/> Fri
<input type="checkbox"/> Sat	
<input type="radio"/> Monthly, on date	1 ▾
<input type="radio"/> Cycle duration:	1 ▾ days (Cycle will start on the Start Date.)

Note:

Comment can only contain A-Z a-z 0-9 , . { } - _ () ^ \$! ~ ` |

OK

Clear

Cancel

Available settings are explained as follows:

Item	Description
Enable Schedule Setup	Check to enable the schedule.
Comment	Type a short description for such schedule.
Start Date (yyyy-mm-dd)	Specify the starting date of the schedule.
Start Time (hh:mm)	Specify the starting time of the schedule.
Duration Time (hh:mm)	Specify the duration (or period) for the schedule.
Action	Specify which action Call Schedule should apply during the period of the schedule. Force On -Force the connection to be always on. Force Down -Force the connection to be always down. Enable Dial-On-Demand -Specify the connection to be dial-on-demand and the value of idle timeout should be specified in Idle Timeout field. Disable Dial-On-Demand -Specify the connection to be up when it has traffic on the line. Once there is no traffic over idle timeout, the connection will be down and never up again during the schedule.
Idle Timeout	Specify the duration (or period) for the schedule.
How Often	Specify how often the schedule will be applied. <ul style="list-style-type: none"> ● Once -The schedule will be applied just once ● Weekdays -Specify which days in one week should perform the schedule. ● Monthly, on date - The router will only execute the action applied such schedule on the date (1 to 28) of a month.

-
- **Cycle duration** - Type a number as cycle duration. Then, any action applied such schedule will be executed per several days. For example, "3" is selected as cycle duration. That means, the action applied such schedule will be executed every three days since the date defined on the Start Date.
-

3. Click OK button to save the settings.

Example

Suppose you want to control the PPPoE Internet access connection to be always on (Force On) from 9:00 to 18:00 for whole week. Other time the Internet access connection should be disconnected (Force Down).

Office
Hour:
(Force On)



Mon - Sun 9:00 am to 6:00 pm

1. Make sure the PPPoE connection and **Time Setup** is working properly.
2. Configure the PPPoE always on from 9:00 to 18:00 for whole week.
3. Configure the **Force Down** from 18:00 to next day 9:00 for whole week.
4. Assign these two profiles to the PPPoE Internet access profile. Now, the PPPoE Internet connection will follow the schedule order to perform **Force On** or **Force Down** action according to the time plan that has been pre-defined in the schedule profiles.

II-5-3 RADIUS

Remote Authentication Dial-In User Service (RADIUS) is a security authentication client/server protocol that supports authentication, authorization and accounting, which is widely used by Internet service providers. It is the most common method of authenticating and authorizing dial-up and tunneled network users.

The built-in RADIUS client feature enables the router to assist the remote dial-in user or a wireless station and the RADIUS server in performing mutual authentication. It enables centralized remote access authentication for network management.

Vigor router can be operated as a RADIUS client. Therefore, this page is used to configure settings for external RADIUS server. Then LAN user of Vigor router will be authenticated by such server for network application.

[Applications >> RADIUS](#)

RADIUS Setup

<input checked="" type="checkbox"/> Enable	
Server IP Address/Hostname	<input type="text" value="0.0.0.0"/> <input type="button" value="Advanced"/>
Destination Port	<input type="text" value="1812"/>
Shared Secret	<input type="text" value="Max: 36 characters"/>
Confirm Shared Secret	<input type="text" value="Max: 36 characters"/>
RADIUS Server Status Log	
<input type="button" value="Refresh"/> <input type="button" value="Clear"/>	

Note:

If your radius server does not support MS-CHAP / MS-CHAPv2, please go to [VPN and Remote Access >> PPP General Setup](#), and select 'PAP Only' for 'Dial-In PPP Authentication'.

Available settings are explained as follows:

Item	Description
Enable	Check to enable RADIUS client feature.
Server IP Address / Hostname	Enter the IP address / hostname of RADIUS server
Destination Port	The UDP port number that the RADIUS server is using. The default value is 1812, based on RFC 2138.
Shared Secret	The RADIUS server and client share a secret that is used to authenticate the messages sent between them. Both sides must be configured to use the same shared secret. The maximum length of the shared secret you can set is 36 characters.
Confirm Shared Secret	Re-Enter the Shared Secret for confirmation.

After finished the above settings, click OK button to save the settings.

II-5-4 UPnP

The UPnP (Universal Plug and Play) protocol is supported to bring to network connected devices the ease of installation and configuration which is already available for directly connected PC peripherals with the existing Windows 'Plug and Play' system. For NAT routers, the major feature of UPnP on the router is "NAT Traversal". This enables applications inside the firewall to automatically open the ports that they need to pass through a router.



Info

UPnP is required for some applications such as PPS, Skype, eMule...and etc. If you are not familiar with UPnP, it is suggested to turn off this function for security.

Applications >> UPnP

UPnP

<input type="checkbox"/> Enable UPnP Service	Default WAN ▼
<input type="checkbox"/> Enable Connection Control Service	
<input type="checkbox"/> Enable Connection Status Service	

Note:

To allow NAT pass-through to a UPnP enabled client the connection control service must also be enabled.

OK

Clear

Cancel

Available settings are explained as follows:

Item	Description
Enable UPnP Service	Accordingly, you can enable either the Connection Control Service or Connection Status Service.

The reminder as regards concern about Firewall and UPnP:

Can't work with Firewall Software

Enabling firewall applications on your PC may cause the UPnP function not working properly. This is because these applications will block the accessing ability of some network ports.

Security Considerations

Activating the UPnP function on your network may incur some security threats. You should consider carefully these risks before activating the UPnP function.

- Some Microsoft operating systems have found out the UPnP weaknesses and hence you need to ensure that you have applied the latest service packs and patches.
- Non-privileged users can control some router functions, including removing and adding port mappings.

The UPnP function dynamically adds port mappings on behalf of some UPnP-aware applications. When the applications terminate abnormally, these mappings may not be removed.

II-5-5 IGMP

IGMP is the abbreviation of *Internet Group Management Protocol*. It is a communication protocol which is mainly used for managing the membership of Internet Protocol multicast groups.

II-5-5-1 General Setting

Applications >> IGMP

General setting
Working groups

IGMP Proxy
 IGMP Proxy acts as a multicast proxy for hosts on the LAN side. Enable IGMP proxy to access any multicast group. This function **takes no effect when Bridge Mode is enabled.**

Interface:

IGMP version:

General Query Interval: (seconds)

Add PPP header:
 (Encapsulate IGMP in PPPoE)

IGMP Snooping
 Enable: Forwards multicast traffic only to ports that are members of that group.
 Disable: Treats multicast traffic the same as broadcast traffic.

IGMP Fast Leave
 The router stops forwarding multicast traffic to a LAN port as soon as it receives a leave message from that port. Each LAN port should have no more than one IGMP host connected.

Available settings are explained as follows:

Item	Description
IGMP Proxy	<p>Check this box to enable this function. The application of multicast will be executed through WAN /PVC/VLAN port. In addition, such function is available in NAT mode.</p> <p>Interface - Specify an interface for packets passing through.</p> <p>IGMP version - At present, two versions (v2 and v3) are supported by Vigor router. Choose the correct version based on the IPTV service you subscribe.</p> <p>General Query Interval - Vigor router will periodically check which IP obtaining IPTV service by sending query. It might cause inconvenience for client. Therefore, set a suitable time (unit: second) as the query interval to limit the frequency of query sent by Vigor router.</p> <p>Add PPP header - Check this box if the interface type for IGMP is PPPoE. It depends on the specifications regulated by each ISP. If you have no idea to enable or disable, simply contact your ISP providers.</p>
IGMP Snooping	<p>Check this box to enable this function. Multicast traffic will be forwarded to ports that have members of that group. Disabling IGMP snooping will make multicast traffic treated in the same manner as broadcast traffic.</p>
IGMP Fast Leave	<p>Check this box to make the router stop forwarding multicast traffic to a LAN port as soon as it receives a leave message from that port. Each LAN port should have one IGMP host connected.</p>

After finishing all the settings here, please click OK to save the configuration.

II-5-5-2 Working Group

Applications >> IGMP

General setting	Working groups		
Refresh			
Working Multicast Groups			
Index	Group ID	P1	P2

Available settings are explained as follows:

Item	Description
Refresh	Click this link to renew the working multicast group status.
Group ID	This field displays the ID port for the multicast group. The available range for IGMP starts from 224.0.0.0 to 239.255.255.254.
P1 to P2	It indicates the LAN port used for the multicast group.

II-5-6 SMS Alert Service

The function of SMS (Short Message Service) Alert is that Vigor router sends a message to user's mobile or e-mail box through specified service provider to assist the user knowing the real-time abnormal situations.

Vigor router allows you to set up to 10 SMS profiles which will be sent out according to different conditions.

This page allows you to specify SMS provider, who will get the SMS, what the content is and when the SMS will be sent.

Applications >> SMS Alert Service

SMS Alert		Set to Factory Default			
Index	Enable	SMS Provider	Recipient Number	Notify Profile	Schedule(1-15)
1	<input type="checkbox"/>	1 - ???		1 - ???	
2	<input type="checkbox"/>	1 - ???		1 - ???	
3	<input type="checkbox"/>	1 - ???		1 - ???	
4	<input type="checkbox"/>	1 - ???		1 - ???	
5	<input type="checkbox"/>	1 - ???		1 - ???	
6	<input type="checkbox"/>	1 - ???		1 - ???	
7	<input type="checkbox"/>	1 - ???		1 - ???	
8	<input type="checkbox"/>	1 - ???		1 - ???	
9	<input type="checkbox"/>	1 - ???		1 - ???	
10	<input type="checkbox"/>	1 - ???		1 - ???	

Note:

- All the SMS Alert profiles share the same "Sending Interval" setting if they use the same SMS Provider.
- If SMS Provider is "LTE Modem", the "Quota" is controlled by LTE >> [SMS Quota Limit](#) and the "Sending Interval" is 3 seconds.

OK Cancel

Available settings are explained as follows:

Item	Description
Enable	Check the box to enable such profile.
SMS Provider	Use the drop down list to choose SMS service provider. You can click SMS Provider link to define the SMS server.
Recipient Number	Enter the phone number of the one who will receive the SMS.
Notify Profile	Use the drop down list to choose a message profile. The recipient will get the content stated in the message profile. You can click the Notify Profile link to define the content of the SMS.
Schedule (1-15)	Enter the schedule number that the SMS will be sent out. You can click the Schedule(1-15) link to define the schedule.

After finishing all the settings here, please click OK to save the configuration.

Application Notes

A-1 How to use DrayDDNS?

Vigor router supports various DDNS service providers, user can set up user-defined profile to update the DDNS even the service provider is not on the list. Now, DrayTek starts to support our own DDNS service - DrayDDNS. We will provide a domain name for each Vigor Router, this single domain name can record IP addresses of all WAN.

Activate DrayDDNS License

1. Go to **Wizards >> Service Activation Wizard**, wait for the router to connect to MyVigor server, then tick **DT-DDNS** and **I have read and accept the above Agreement**, click **Next**.

Service Activation Wizard

Select the service type that you want to activate

Activation Date : 2019-02-25

Web Content Filter(WCF) Service :

BPjM [License Agreement](#)
This is a web content filter that is provided by the German government. It is a free service without any guarantee and will expire one year after activation. You may re-activate the service after expiry.

Cyren 30-Days Free Trial [License Agreement](#)
This is a worldwide web content filter service. The free trail license can only be used once. At the end of the free trail period you may purchase the official one-year Cyren Web Content Filter from an authorized DrayTek reseller.

Dynamic DNS(DDNS) Service :

DT-DDNS [License Agreement](#)
This is a Dynamic Domain Name Service that is provided by DrayTek company. It is a free service will expire 1 year after activation.
You may re-activate the service after expiry.

Domain Name : .draydns.com

I have read and accept the above Agreement. (Please check this box).

2. Confirm the information, then click **Activate**.

Service Activation Wizard

Please confirm your settings

Service Type : Trial version

Service Activated : Dynamic DNS (.draydns.com)

Please click **Back** to re-select service type you to activate.

- MyVigor server will reply with the service activation information.

Service Activation Wizard

Please confirm your settings

DrayTek Service Activation

Service Name	Start Date	Expire Date	Status
Web Content filter	2019-02-25	2019-03-25	Cyren
DDNS	2019-02-25	2019-03-25	DT-DDNS

Please check if the license fits with the service provider of your signature. To ensure normal operation for your router, update your signature again is recommended.

Copyright © DrayTek Corp. All Rights Reserved.

Configure DDNS Profile

- Go to Applications >> Dynamic DNS Setup,
 - Tick Enable Dynamic DNS Setup
 - Click an available profile index
 - Tick Enable Dynamic DNS Account
 - Select DrayTek Global (www.drayddns.com) as Service Provider
 - Select the WAN you would like to upload the IP to DDNS server
 - Click Get domain
 - Click OK on the pop up notification window

Applications >> Dynamic DNS Setup

Dynamic DNS Setup | Set to Factory Default |

Enable Dynamic DNS Setup

Auto-Update interval Min(s) (180~14400)

Accounts:

Index	WAN Interface
1.	WAN1 Only
2.	WAN1 First
3.	WAN1 First
4.	WAN1 First
5.	WAN1 First
6.	WAN1 First

Applications >> Dynamic DNS Setup >> Dynamic DNS Account Setup

Index : 2

Enable Dynamic DNS Account

Service Provider

Status Activated [Start Date:2017-02-23 Expire Date:2018-02-23]

Domain Name

Determine Real WAN IP

Determine WAN IP

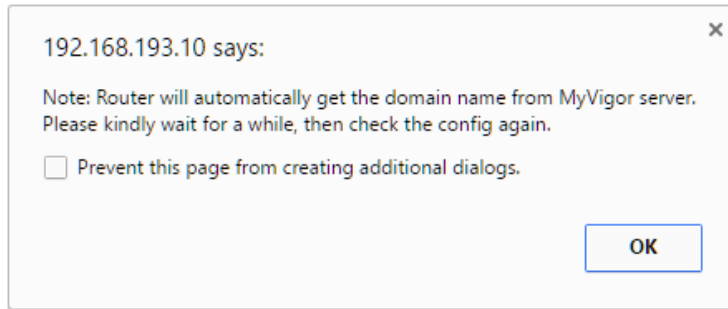

2. Wait few seconds for router to get the domain name, then, we can click the profile to check the information of license and domain name.

Applications >> Dynamic DNS Setup

Dynamic DNS Setup | Set to Factory Default |

Enable Dynamic DNS Setup View Log Force Update

Auto-Update interval Min(s) (180~14400)

Accounts:

Index	WAN Interface	Domain Name	Active
1.	WAN1 Only	Customized	v
2.	WAN 1/2/3/4	192.168.193.10 draydns.com	v
3.	WAN1 First		x
4.	WAN1 First		
5.	WAN1 First		
6.	WAN1 First		

Applications >> Dynamic DNS Setup >> Dynamic DNS Account Setup

Index : 2

Enable Dynamic DNS Account

Service Provider

Status Activated [Start Date:2017-02-23 Expire Date:2018-02-23]

Domain Name .draydns.com Edit domain

Determine Real WAN IP

Determine WAN IP

OK Clear Cancel

Modify Domain Name

Currently, only the domain name is allowed to be modified MyVigor website. We will need to register the router to MyVigor server, and log in to MyVigor website to modify it.

1. Please visit <https://myvigor.draytek.com/> or go to Applications >> Dynamic DNS Setup >> DrayDDNS profile and click Edit domain.

Applications >> Dynamic DNS Setup >> Dynamic DNS Account Setup

Index : 2

Enable Dynamic DNS Account

Service Provider

Status Activated [Start Date:2017-02-23 Expire Date:2018-02-23]

Domain Name .draydns.com Edit domain

Determine Real WAN IP

Determine WAN IP

OK Clear Cancel

2. Log in to MyVigor Website, choose the profile, then click Edit DDNS settings.

My Information - My Products

Device Information
 Device Name : 1472225
 Serial Number : 1140494114
 Model : Vigor2925 Series

Rename Transfer Back

Device's Service Expired License

Service	Provider	Action	Status	Start Date	Expired Date	Note
WCF	BPJM	Activate	On	-	-	-
WCF	Cyren	Trial	On	-	-	-
APPE	DT-APPE	Activate	On	-	-	-
DDNS	DT-DDNS	Renew	On	2017-02-23	2018-02-23	Edit DDNS settings

- Input the desired Domain name (e.g., XXXX25) and click Update.

Edit DDNS Settings

Please note that the DrayDDNS service is currently for internal use only.

Domain Name: .drayddns.com

Current IP:

Last Update: 2017/2/24 14:27:20

Status: Update success

- Vigor router will get the modified domain name when the it performs next DDNS updating. We can click Sync domain to accelerate this process.

Applications >> Dynamic DNS Setup >> Dynamic DNS Account Setup

Index : 2

Enable Dynamic DNS Account

Service Provider: DrayTek Global (www.drayddns.com)

Status: Activated [Start Date:2017-02-23 Expire Date:2018-02-23]

Domain Name: .drayddns.com

WAN Interfaces: WAN IP

Determine WAN IP: WAN 1, WAN 2, WAN 3, WAN 4

After few seconds, the router will get the new domain name and print it on the profiles list.

Applications >> Dynamic DNS Setup

Dynamic DNS Setup | [Set to Factory Default](#)

Enable Dynamic DNS Setup View Log Force Update

Auto-Update interval Min(s) (180~14400)

Accounts:

Index	WAN Interface	Domain Name	Active
1.	WAN1 Only	Customized	v
2.	WAN 1/2/3/4	!:@#%&'()*+,-./:;?[]^_`{ }~draydns.com	v
3.	WAN1 First		x
4.	WAN1 First		x
5.	WAN1 First		x
6.	WAN1 First		x

Applications >> Dynamic DNS Setup

Dynamic DNS Setup | [Set to Factory Default](#)

Enable Dynamic DNS Setup View Log Force Update

Auto-Update interval Min(s) (180~14400)

Accounts:

Index	WAN Interface	Domain Name	Active
1.	WAN1 Only	Customized	v
2.	WAN 1/2/3/4	!@#%&'()*+,-./:;?[]^_`{ }~25.draydns.com	v
3.	WAN1 First		x
4.	WAN1 First		x
5.	WAN1 First		x
6.	WAN1 First		x



A-2 How to Configure Customized DDNS?

This article describes how to configure customized DDNS on Vigor routers to update your IP to the DDNS server. We will take "Changeip.org" and "3322.net" as example. Before setting, please make sure that the WAN connection is up.

Part A : Changeip.org

Physical Connection			System Uptime: 0day 2:25:59		
IPv4		IPv6			
LAN Status		Primary DNS: 168.95.192.1		Secondary DNS: 168.95.1.1	
IP Address	TX Packets	RX Packets			
10.1.7.1	2069	1036			
WAN 1 Status >> Drop PPPoE					
Enable	Line	Name	Mode	Up Time	
Yes	Ethernet	iwiz	PPPoE	2:25:53	
IP	GW IP	TX Packets	TX Rate(Bps)	RX Packets	RX Rate(Bps)
1.169.185.242	168.95.98.254	14851	9506	11281	912

Note that,

Username: jo***

Password: jo*****

Host name: j*****.changeip.org

WAN IP address: 1.169.185.242

Following is the screenshot of editing the HTML script on the browser to update your IP to the DDNS server.



```
200 Successful Update (Address Used: 1.169.185.242)

Updated target: j****.changeip.org
Updated 1 host records
Updated 0 zone serial numbers
Reviewed 1 possible records
Total updates: 75
Lockout counter: 1 out of 60
Lockout reset: 60 mins
Elapsed time: 0.01 seconds
NIC version: 2.68

For XML output add &xml=1
Use SSL for better security.
```

Now we have to configure the router so it can do the same job for us automatically.

1. Please go to **Applications >> Dynamic DNS** to create a profile for user-defined DDNS client.

Applications >> Dynamic DNS Setup >> Dynamic DNS Account Setup

Index : 1

Enable Dynamic DNS Account

Service Provider: User-Defined ?

Provider Host: ChangeIP.org

Service API: /dynamic/dns/update.asp?
u=jo***&p=jo*****&hostname=j***.changeip.org&ip=###IP###&c
md=update&offline=0

Auth Type: basic

Connection Type: Http

Server Response:

Login Name: chronic6633 (max. 64 characters)

Password: ***** (max. 64 characters)

Wildcards

Backup MX

Mail Extender:

Determine Real WAN IP: WAN IP

OK
Clear
Cancel

2. Set the Service Provider as **User-Defined**.
3. Set the Service API as:
/dynamic/dns/update.asp?u=jo***&p=jo*****&hostname=j***.changeip.org&ip=###IP###&cmd=update&offline=0

In which, ###IP### is a value which will be replaced with the current interface IP address automatically when DDNS service is running. In this case the IP will be 1.169.185.242.

4. After setting, the Customized DDNS service will be up, and our IP will be updated to the DDNS server.

Part B : 3322.net

WAN 1	
Link Status	: Connected
MAC Address	: 00-50-7F-C8-C6-A1
Connection	: PPPoE
IP Address	: 111.243.178.53
Default Gateway	: 168.95.98.254
Primary DNS	: 168.95.192.1
Secondary DNS	: 168.95.1.1

Username: bi*****

Password: 88*****

Host name: bi*****.3322.org

WAN IP address: 111.243.178.53

To update the IP to the DDNS server via editing the HTML script, we can Enter the following script on the browser:

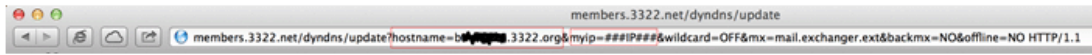

And the result will be :

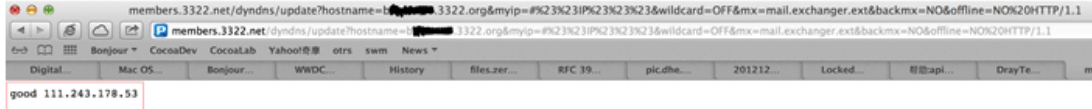

“good 111.243.178.53” means our IP has been updated to the server successfully.

Now we have to configure the router so it can do the same job for us automatically.

1. Please go to **Applications >> Dynamic DNS** to create a profile for User-Defined DDNS client.

Applications >> Dynamic DNS Setup >> Dynamic DNS Account Setup

Index : 1

Enable Dynamic DNS Account

Service Provider ?

Provider Host

Service API

Auth Type

Connection Type

Server Response

Login Name (max. 64 characters)

Password (max. 64 characters)

Wildcards

Backup MX

Mail Extender

Determine Real WAN IP

2. Set the Service Provider as **User-Defined**.
3. Set the Provider Host as **member.3322.net**.
4. Set the Service API as:
`/dyndns/update?hostname=yourhost.3322.org&myip=###IP###&wildcard=OFF&mx=mail.exchanger.ext&backmx=NO&offline=NO`
5. Enter your account and password.
6. After the setting, the Customized DDNS service will be up, and our IP will be updated to the DDNS server automatically.

Part C : Extend Note

The customized Service Provider is also eligible with the CloudDNS.net.

OK

Applications >> Dynamic DNS Setup >> Dynamic DNS Account Setup

Index : 1

Enable Dynamic DNS Account

Service Provider: User-Defined

Provider Host: memberj3322.net

Service API: /dyndns/update?
hostname=bi*****.3322.org&myip=###IP###&wildcard=OFF&mx=mail
.exchanger.ext&backmx= NO&offline=NO

Auth Type: basic

Connection Type: Http

Server Response:

Login Name: chronic6633 (max. 64 characters)

Password: ***** (max. 64 characters)

Wildcards

Backup MX

Mail Extender:

Determine Real WAN IP: WAN IP

OK Clear Cancel

II-6 Routing

Route Policy (also well known as PBR, policy-based routing) is a feature where you may need to get a strategy for routing. The packets will be directed to the specified interface if they match one of the policies. You can setup route policies in various reasons such as load balance, security, routing decision, and etc.

Through protocol, IP address, port number and interface configuration, Route Policy can be used to configure any routing rules to fit actual request. In general, Route Policy can easily reach the following purposes:

Specify Interface

Through dedicated interface (WAN/LAN/VPN), the data can be sent from the source IP to the destination IP.

Address Mapping

Allows you specify the outgoing WAN IP address (es) for an internal private IP address or a range of internal private IP addresses.

Priority

The router will determine which policy will be adopted for transmitting the packet according to the priority of Static Route and Route Policy.

Failover to/Failback

Packets will be sent through another Interface or follow another Policy when the original interface goes down (**Failover to**). Once the original interface resumes service (**Failback**), the packets will be returned to it immediately.

Other routing

Specify routing policy to determine the direction of the data transmission.



Info

For more detailed information about using policy route, refer to **Support >>FAQ/Application Notes** on www.draytek.com.

Web User Interface

LAN
Routing
Static Route
NAT

II-6-1 Static Route

Static routing is an alternative to dynamic routing. It is a process that the system network administrator can configure network routers with all the required information for packet forwarding.

Go to **Routing >> Static Route**. The router offers IPv4 and IPv6 for you to configure the static route. Both protocols bring different web pages.

Static Route for IPv4

Routing >> Static Route Setup

IPv4			IPv6			Set to Factory Default	View Routing Table
Index	Enable	Destination Address	Index	Enable	Destination Address		
1.	<input type="checkbox"/>	???	6.	<input type="checkbox"/>	???		
2.	<input type="checkbox"/>	???	7.	<input type="checkbox"/>	???		
3.	<input type="checkbox"/>	???	8.	<input type="checkbox"/>	???		
4.	<input type="checkbox"/>	???	9.	<input type="checkbox"/>	???		
5.	<input type="checkbox"/>	???	10.	<input type="checkbox"/>	???		

Available settings are explained as follows:

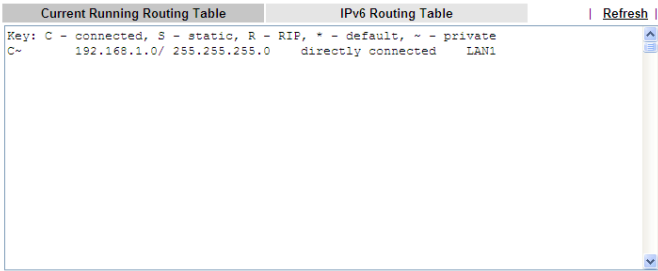
Item	Description
Set to Factory Default	Clear all of the settings and return to factory default settings.
Viewing Routing Table	Displays the routing table for your reference. Diagnostics >> View Routing Table 
Index	The number (1 to 30) under Index allows you to open next page to set up static route.
Enable	Check the box to enable such route.
Destination Address	Displays the destination address of the static route.

Add Static Routes to Private and Public Networks

Here is an example (based on IPv4) of setting Static Route in Main Router so that user A and B locating in different subnet can talk to each other via the router. Assuming the Internet access has been configured and the router works properly:

- use the Main Router to surf the Internet.
- create a private subnet 192.168.10.0 using an internal Router A (192.168.1.2)
- create a public subnet 211.100.88.0 via an internal Router B (192.168.1.3).
- have set Main Router 192.168.1.1 as the default gateway for the Router A 192.168.1.2.

Before setting Static Route, user A cannot talk to user B for Router A can only forward recognized packets to its default gateway Main Router.

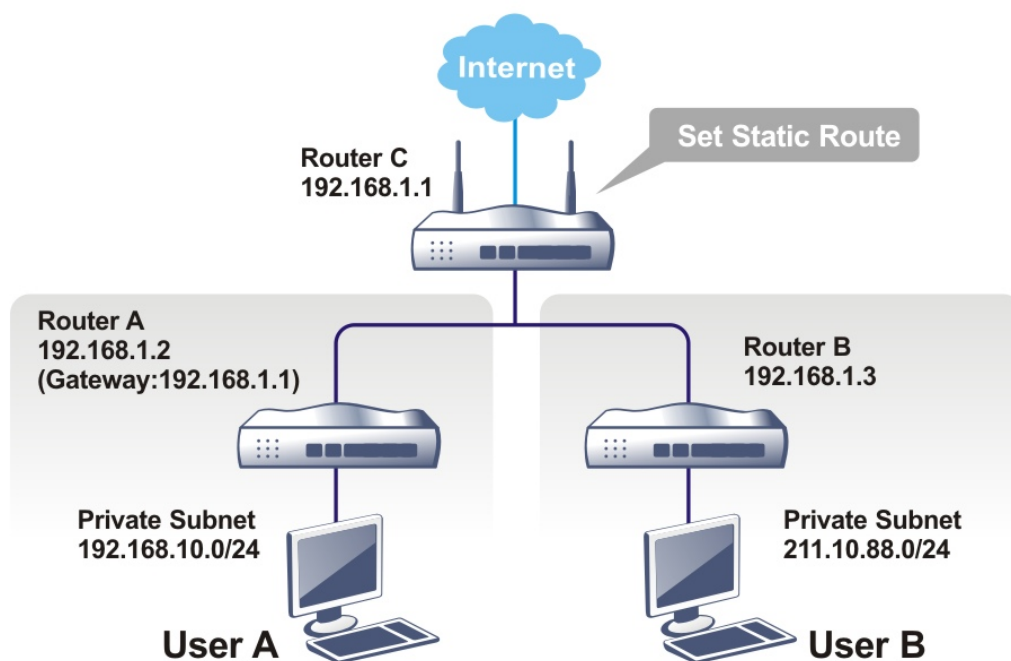

1. Go to LAN page and click **General Setup**, select 1st Subnet as the RIP Protocol Control. Then click the OK button.



Info

There are two reasons that we have to apply RIP Protocol Control on 1st Subnet. The first is that the LAN interface can exchange RIP packets with the neighboring routers via the 1st subnet (192.168.1.0/24). The second is that those hosts on the internal private subnets (ex. 192.168.10.0/24) can access the Internet via the router, and continuously exchange of IP routing information with different subnets.

- Click the **LAN >> Static Route** and click on the **Index Number 1**. Check the **Enable** box. Please add a static route as shown below, which regulates all packets destined to 192.168.10.0 will be forwarded to 192.168.1.2. Click **OK**.

Routing >> Static Route Setup

Index No. 1

<input type="checkbox"/> Enable	
Destination IP Address	???
Subnet Mask	255.255.255.255 / 32 ▼
Gateway IP Address	
Network Interface	LAN1 ▼

Note:

WAN5, WAN6, WAN7 are PVCs or VLANs that can be configured on the [Multi-PVC/VLAN](#) page.

OK Cancel Delete

Available settings are explained as follows:

Item	Description
Enable	Click it to enable this profile.
Destination IP Address	Type an IP address as the destination of such static route.
Subnet Mask	Enter the subnet mask for such static route.
Gateway IP Address	Enter the IP address of the gateway.
Network Interface	Use the drop down list to specify an interface for such static route.

- Return to **Static Route Setup** page. Click on another **Index Number** to add another static route as show below, which regulates all packets destined to 211.100.88.0 will be forwarded to 192.168.1.3. Click **OK**.

LAN >> Static Route Setup

Index No. 1

<input checked="" type="checkbox"/> Enable	
Destination IP Address	211.100.88.0
Subnet Mask	255.255.255.0
Gateway IP Address	192.168.1.3
Network Interface	LAN1 ▼

OK Cancel Delete

- Go to **Diagnostics** and choose **Routing Table** to verify current routing table.

Diagnostics >> View Routing Table

Current Running Routing Table		IPv6 Routing Table		Refresh
Key: C - connected, S - static, R - RIP, * - default, ~ - private				
S~	192.168.10.0/ 255.255.255.0	via 192.168.1.2	LAN1	
C~	192.168.1.0/ 255.255.255.0	directly connected	LAN1	
S~	211.100.88.0/ 255.255.255.0	via 192.168.1.3	LAN1	

Static Route for IPv6

You can set up to 40 profiles for IPv6 static route. Click the IPv6 tab to open the following page:

Routing >> Static Route Setup

IPv4		IPv6		Set to Factory Default	View IPv6 Routing Table
Index	Enable	Destination Address	Index	Enable	Destination Address
<u>1.</u>	<input type="checkbox"/>	::/0	<u>11.</u>	<input type="checkbox"/>	::/0
<u>2.</u>	<input type="checkbox"/>	::/0	<u>12.</u>	<input type="checkbox"/>	::/0
<u>3.</u>	<input type="checkbox"/>	::/0	<u>13.</u>	<input type="checkbox"/>	::/0
<u>4.</u>	<input type="checkbox"/>	::/0	<u>14.</u>	<input type="checkbox"/>	::/0
<u>5.</u>	<input type="checkbox"/>	::/0	<u>15.</u>	<input type="checkbox"/>	::/0
<u>6.</u>	<input type="checkbox"/>	::/0	<u>16.</u>	<input type="checkbox"/>	::/0
<u>7.</u>	<input type="checkbox"/>	::/0	<u>17.</u>	<input type="checkbox"/>	::/0
<u>8.</u>	<input type="checkbox"/>	::/0	<u>18.</u>	<input type="checkbox"/>	::/0
<u>9.</u>	<input type="checkbox"/>	::/0	<u>19.</u>	<input type="checkbox"/>	::/0
<u>10.</u>	<input type="checkbox"/>	::/0	<u>20.</u>	<input type="checkbox"/>	::/0

<< 1 - 20 | 21 - 40 >> Next >>

Available settings are explained as follows:

Item	Description
Set to Factory Default	Clear all of the settings and return to factory default settings.
Viewing IPv6 Routing Table	Displays the routing table for your reference.
Index	The number (1 to 40) under Index allows you to open next page to set up static route.
Enable	Check the box to enable such static route.
Destination Address	Displays the destination address of the static route.

Click any underline of index number to get the following page.

LAN >> Static Route Setup

Index No. 1

<input type="checkbox"/> Enable	
Destination IPv6 Address / Prefix Len	:: / 0
Gateway IPv6 Address	
Network Interface	LAN1 ▼

OK Cancel Delete

Available settings are explained as follows:

Item	Description
Enable	Click it to enable this profile.
Destination IPv6 Address / Prefix Len	Enter the IP address with the prefix length for this entry.
Gateway IPv6 Address	Enter the gateway address for this entry.
Network Interface	Use the drop down list to specify an interface for this static route.

When you finish the configuration, please click **OK** to save and exit this page.

Part III Wireless LAN



Wireless

Wireless LAN enables high mobility so WLAN users can simultaneously access all LAN facilities just like on a wired LAN as well as Internet access.

III-1 Wireless LAN

This function is used for “n” model only.

Over recent years, the market for wireless communications has enjoyed tremendous growth. Wireless technology now reaches or is capable of reaching virtually every location on the surface of the earth. Hundreds of millions of people exchange information every day via wireless communication products. The VigorLTE 200 wireless series router (with “n”, or “ac” in model name) is designed for maximum flexibility and efficiency of a small office/home. Any authorized staff can bring a built-in WLAN client PDA or notebook into a meeting room for conference without laying a clot of LAN cable or drilling holes everywhere. Wireless LAN enables high mobility so WLAN users can simultaneously access all LAN facilities just like on a wired LAN as well as Internet access.

The Vigor wireless routers are equipped with a wireless LAN interface compliant with the standard IEEE 802.11n draft 2 protocol. To boost its performance further, the Vigor Router is also loaded with advanced wireless technology to lift up data rate up to 300 Mbps*. Hence, you can finally smoothly enjoy stream music and video.

VigorLTE 200 wireless router is a highly integrated wireless local area network (WLAN) for 5 GHz 802.11ac or 2.4/5 GHz 802.11n WLAN applications. It supports channel operations of 20/40 MHz at 2.4 GHz and 20/40/80 MHz at 5 GHz. VigorLTE 200 “ac” series router can support data rates up to 1.3 Gbps in 802.11ac 80 MHz channels. VigorLTE 200 “n” series router supports 802.11n up to 300 Mbps for 40 MHz channel operations.



Info

The actual data throughput will vary according to the network conditions and environmental factors, including volume of network traffic, network overhead and building materials.

In an Infrastructure Mode of wireless network, Vigor wireless router plays a role as an Access Point (AP) connecting to lots of wireless clients or Stations (STA). All the STAs will share the same Internet connection via Vigor wireless router. The **General Settings** will set up the information of this wireless network, including its SSID as identification, located channel etc.

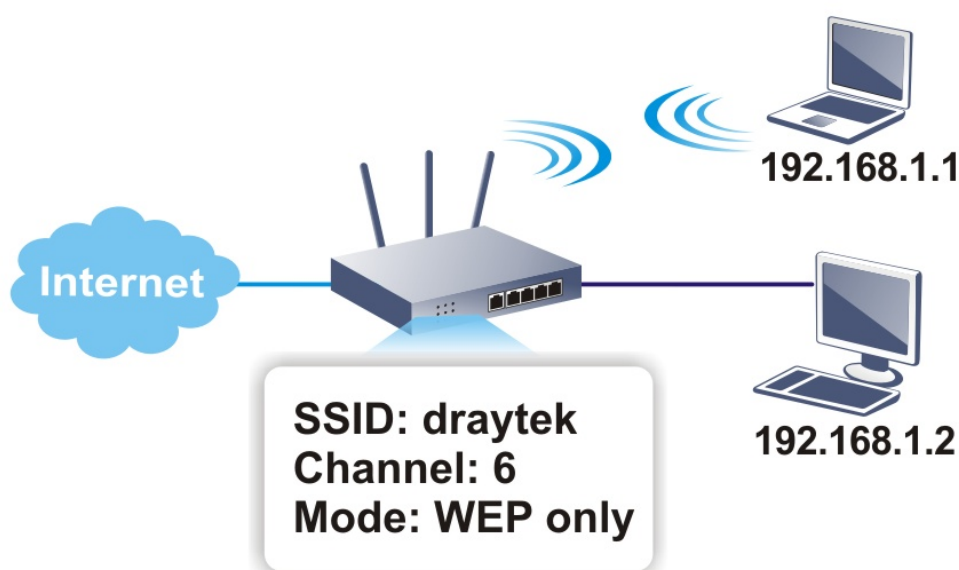

Multiple SSIDs

Vigor router supports four SSID settings for wireless connections. Each SSID can be defined with different name and download/upload rate for selecting by stations connected to the router wirelessly.

Real-time Hardware Encryption

Vigor Router is equipped with a hardware AES encryption engine so it can apply the highest protection to your data without influencing user experience.

Complete Security Standard Selection

To ensure the security and privacy of your wireless communication, we provide several prevailing standards on market.

WEP (Wired Equivalent Privacy) is a legacy method to encrypt each frame transmitted via radio using either a 64-bit or 128-bit key. Usually access point will preset a set of four keys and it will communicate with each station using only one out of the four keys.

WPA (Wi-Fi Protected Access), the most dominating security mechanism in industry, is separated into two categories: WPA-personal or called WPA Pre-Share Key (WPA/PSK), and WPA-Enterprise or called WPA/802.1x.

In WPA-Personal, a pre-defined key is used for encryption during data transmission. WPA applies Temporal Key Integrity Protocol (TKIP) for data encryption while WPA2 applies AES. The WPA-Enterprise combines not only encryption but also authentication.

Since WEP has been proved vulnerable, you may consider using WPA for the most secure connection. You should select the appropriate security mechanism according to your needs. No matter which security suite you select, they all will enhance the over-the-air data protection and /or privacy on your wireless network. The Vigor wireless router is very flexible and can support multiple secure connections with both WEP and WPA at the same time.



Info

The password (PSK) of default security mode is provided and stated on the label pasted on the bottom of the router. For the wireless client who wants to access into Internet through such router, please input the default PSK value for connection.

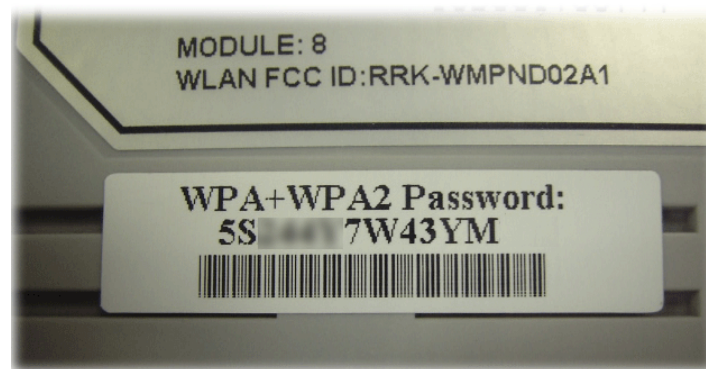

Separate the Wireless and the Wired LAN- WLAN Isolation

It enables you to isolate your wireless LAN from wired LAN for either quarantine or limit access reasons. To isolate means neither of the parties can access each other. To elaborate an example for business use, you may set up a wireless LAN for visitors only so they can connect to Internet without hassle of the confidential information leakage. For a more flexible deployment, you may add filters of MAC addresses to isolate users' access from wired LAN.

Manage Wireless Stations - Station List

It will display all the stations in your wireless network and the status of their connection.

WPS

WPS (Wi-Fi Protected Setup) provides easy procedure to make network connection between wireless station and wireless access point (vigor router) with the encryption of WPA and WPA2.



Info

WPS is available for the wireless station with WPS supported.

It is the simplest way to build connection between wireless network clients and vigor router. Users do not need to select any encryption mode and type any long encryption passphrase to setup a wireless client every time. He/she only needs to press a button on wireless client, and WPS will connect for client and router automatically.

There are two methods to do network connection through WPS between AP and Stations: pressing the *Start PBC* button or using *PIN Code*.

- On the side of VigorLTE 200 series which served as an AP, press WPS button once on the front panel of the router or click Start PBC on web configuration interface. On the side of a station with network card installed, press Start PBC button of network card.

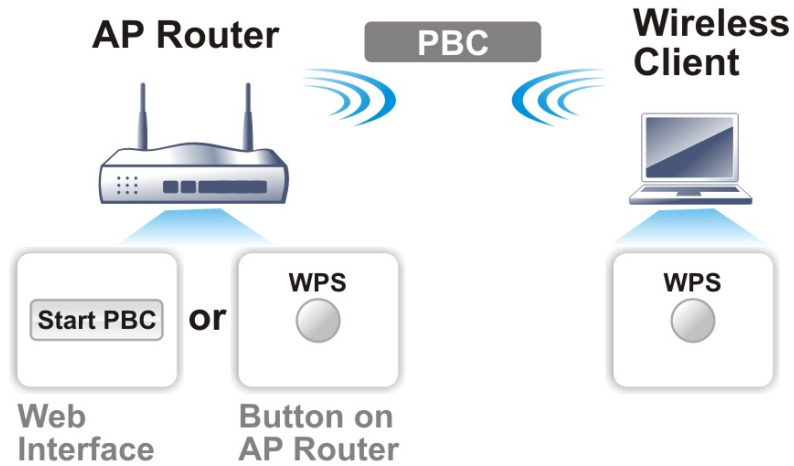

- If you want to use PIN code, you have to know the PIN code specified in wireless client. Then provide the PIN code of the wireless client you wish to connect to the vigor router.

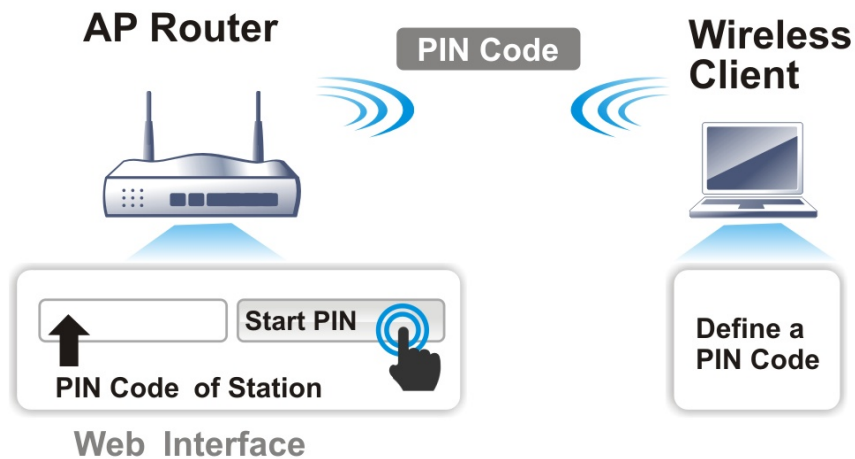

For WPS is supported in WPA-PSK or WPA2-PSK mode, if you do not choose such mode in Wireless LAN>>Security, you will see the following message box.

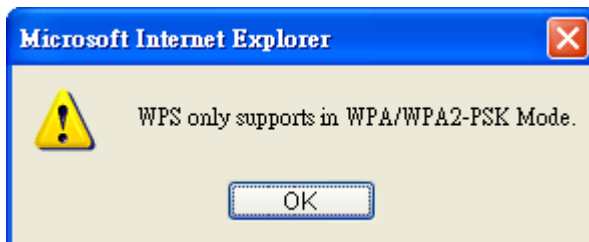

Please click OK and go back Wireless LAN>>Security to choose WPA-PSK or WPA2-PSK mode and access WPS again.

Web User Interface

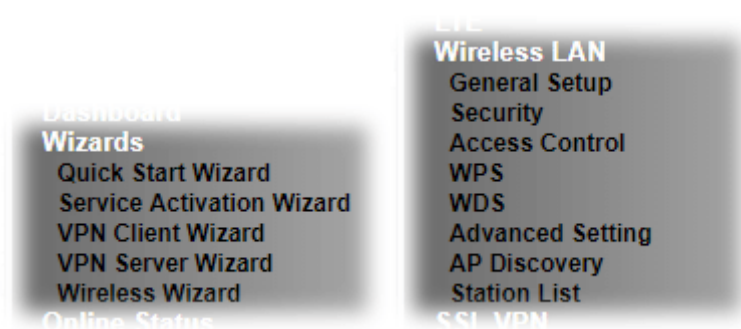

III-1-1 Wireless Wizard

The wireless wizard allows you to configure settings specified for a host AP (for home use or internal use for a company) and specified for a guest AP (for any wireless clients accessing into Internet).

Follow the steps listed below:

1. Open Wizards>>Wireless Wizard.
2. The screen of wireless wizard will be shown as follows. This page will be used for internal users in a company or your home. Besides, the settings will change based on different model of VigorLTE 200 series. In this case, VigorLTE 200Ln is used as an example.

Wireless Wizard

Host AP Configuration

Wireless 2.4GHz Settings

Name:

Mode:

Channel:

Security Key:

Note:
The host AP configured here will be used for home or internal company use.

Available settings are explained as follows:

Item	Description
Name	Enter the SSID name of this router for wireless connection. The default name is defined with DrayTek. Change the name if required.
Mode	At present, the router can connect to 11b Only, 11g Only, 11n Only, Mixed (11b+11g), Mixed (11g+11n) and Mixed (11b+11g+11n) stations simultaneously. Simply choose Mixed (11b+11g+11n) mode.

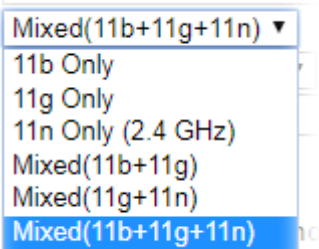
	
Channel	Means the channel of frequency of the wireless LAN. The default channel is 6. You may switch channel if the selected channel is under serious interference. If you have no idea of choosing the frequency, please select Auto to let system determine for you.
Security Key	The wireless mode offered by this wizard is WPA2/PSK. The WPA encrypts each frame transmitted from the radio using the key, which either PSK (Pre-Shared Key) entered manually in this field below or automatically negotiated via 802.1x authentication. Either 8~63 ASCII characters, such as 012345678(or 64 Hexadecimal digits leading by 0x, such as "0x321253abcde...").
Next	Click it to get into the next setting page.
Cancel	Exit the wireless wizard without saving any changes.

- After typing the required information, click Next. The settings in the page limit the wireless station (guest) accessing into Internet but not being allowed to share the LAN network and VPN connection.

Wireless Wizard

Guest AP Configuration

Wireless 2.4GHz Settings

Enable Disable

SSID:

Security Key:

Rate Control: Enable Upload kbps Download kbps

Note:
The configured guest AP will not be able to access the LAN network, VPN connections, or communicate with wireless devices connecting to the router's other APs. This AP interface shall be used for Internet access only.

Available settings are explained as follows:

Item	Description
Enable/Disable	Click it to enable or disable settings in this page.
SSID	Enter the SSID name of this router. (SSID1)
Security Key	The wireless mode offered by this wizard is WPA2/PSK. The WPA encrypts each frame transmitted from the radio using the key, which either PSK (Pre-Shared Key) entered

	manually in this field below or automatically negotiated via 802.1x authentication. Either 8~63 ASCII characters, such as 012345678(or 64 Hexadecimal digits leading by 0x, such as "0x321253abcde...").
Rate Control	Check the box to enable the rate control function. Upload / Download - Enter the values as the limits for data upload and data download.
Next	Click it to get into the next setting page.
Cancel	Exit the wireless wizard without saving any changes.

4. After typing the required information, click **Next**.
5. The following page will display the configuration summary for wireless setting.

Wireless Wizard

Configuration Summary

Wireless 2.4GHz Settings

Mode: Mixed(11b+11g+11n)
Channel: Channel 6, 2437MHz

Host AP
SSID Name: DrayTek
Security Key: 123456789

Guest AP
Status: Disabled
SSID Name: DrayTek_Guest
Security Key:
Rate Control: Disabled

6. Click **Finish** to complete the wireless settings configuration.

III-1-2 General Setup

By clicking the **Wireless LAN>>General Setup**, a new web page will appear so that you could configure the SSID and the wireless channel. Please refer to the following figure for more information.

Wireless LAN >> General Setup

General Setting (IEEE 802.11)

Enable Wireless LAN

Mode : ▼

Channel: ▼

	Enable	Hide SSID	SSID	Isolate Member	Isolate VPN
1	<input checked="" type="checkbox"/>	<input type="checkbox"/>	<input type="text" value="DrayTek"/>	<input type="checkbox"/>	<input type="checkbox"/>
2	<input type="checkbox"/>	<input type="checkbox"/>	<input type="text" value="DrayTek_Guest"/>	<input type="checkbox"/>	<input type="checkbox"/>
3	<input type="checkbox"/>	<input type="checkbox"/>	<input type="text" value="Max: 31 characters"/>	<input type="checkbox"/>	<input type="checkbox"/>
4	<input type="checkbox"/>	<input type="checkbox"/>	<input type="text" value="Max: 31 characters"/>	<input type="checkbox"/>	<input type="checkbox"/>

Note:
Enabling the Isolate Member configuration will forbid the wireless clients associated to the same SSID from connecting to each other.

The isolate VPN configuration will isolate the wireless traffic from VPN connections and thus, wireless clients will not be able to access the VPN network under this setting.

Rate Control

	Enable	Upload	Download
SSID 1	<input type="checkbox"/>	<input type="text" value="30000"/> kbps	<input type="text" value="30000"/> kbps
SSID 2	<input type="checkbox"/>	<input type="text" value="30000"/> kbps	<input type="text" value="30000"/> kbps
SSID 3	<input type="checkbox"/>	<input type="text" value="30000"/> kbps	<input type="text" value="30000"/> kbps
SSID 4	<input type="checkbox"/>	<input type="text" value="30000"/> kbps	<input type="text" value="30000"/> kbps

Note:
Configurable upload and download rates are from 100 to 50,000(kbps).

Schedule Profiles: ▼, ▼, ▼, ▼

Note:
Only schedule profiles that have the action "Force Down" are applied to the WLAN, all other actions are ignored. Valid settings are profile indexes 1 to 15.

Available settings are explained as follows:

Item	Description
Enable Wireless LAN	Check the box to enable wireless function.
Mode	For 2.4GHz: At present, the router can connect to 11b Only, 11g Only, 11n Only(2.4 GHz), Mixed (11b+11g), Mixed (11g+11n), and Mixed (11b+11g+11n) stations simultaneously. Simply choose Mixed (11b+11g+11n) mode.
Channel	Means the channel of frequency of the wireless LAN. The default channel is 6. You may switch channel if the selected channel is under serious interference. If you have no idea of choosing the frequency, please select Auto to let system determine for you.

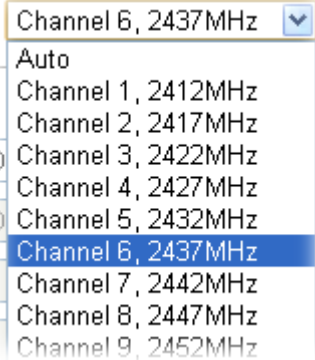
	
Hide SSID	<p>Check it to prevent from wireless sniffing and make it harder for unauthorized clients or STAs to join your wireless LAN. Depending on the wireless utility, the user may only see the information except SSID or just cannot see any thing about Vigor wireless router while site surveying. The system allows you to set four sets of SSID for different usage. In default, the first set of SSID will be enabled. You can hide it for your necessity.</p>
SSID	<p>Means the identification of the wireless LAN. SSID can be any text numbers or various special characters.</p>
Isolate	<p>Member -Check this box to make the wireless clients (stations) with the same SSID not accessing for each other. VPN - Check this box to make the wireless clients (stations) with different VPN not accessing for each other.</p>
Rate Control	<p>Enable - Check the box to set the rate limit for data transmission in upload and download. It controls the data transmission rate through wireless connection. Upload - Check Enable and enter the transmitting rate for data upload. Default value is 30,000 kbps. Download - Enter the transmitting rate for data download. Default value is 30,000 kbps.</p>
Schedule Profiles	<p>Set the wireless LAN to work at certain time interval only. You may choose up to 4 schedules out of the 15 schedules pre-defined in Applications >> Schedule setup. The default setting of this field is blank and the function will always work.</p>

After finishing all the settings here, please click **OK** to save the configuration.

III-1-3 Security

This page allows you to set security with different modes for SSID 1, 2, 3 and 4 respectively. After configuring the correct settings, please click **OK** to save and invoke it.

The password (PSK) of default security mode is provided and stated on the label pasted on the bottom of the router. For the wireless client who wants to access into Internet through such router, please input the default PSK value for connection.

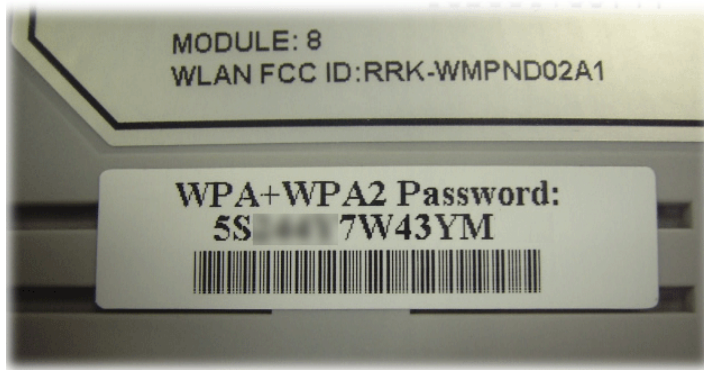



By clicking the **Wireless LAN >> Security Settings**, a new web page will appear so that you could configure the settings of WPA and WEP.

Wireless LAN >> Security Settings

SSID 1	SSID 2	SSID 3	SSID 4
<p>Mode: <input type="text" value="Mixed(WPA+WPA2)/PSK"/></p> <p><u>WPA</u></p> <p>Encryption Mode: TKIP for WPA/AES for WPA2</p> <p>Pre-Shared Key(PSK): <input type="text" value="....."/></p> <p>Password Strength: <input type="button" value="Weak"/> <input type="button" value="Medium"/> <input type="button" value="Strong"/></p> <p>Note: Type 8~63 ASCII characters, for example: "cfgs01a2...".</p> <p>For strong passwords:</p> <ol style="list-style-type: none"> 1. Use at least 12 characters. 2. Include at least 3 of the following 4 types of characters: digits, uppercase letters, lowercase letters, and non-alphanumeric characters (such as \$ % ^). <p><u>WEP</u></p> <p>Encryption Mode: <input type="text" value="64-Bit"/></p> <p><input type="radio"/> Key 1 : <input type="text"/></p> <p><input type="radio"/> Key 2 : <input type="text"/></p> <p><input type="radio"/> Key 3 : <input type="text"/></p> <p><input type="radio"/> Key 4 : <input type="text"/></p> <p>Note: Please configure the <u>RADIUS Server</u> if 802.1X is used. For 64 bit WEP key configurations, please insert 5 ASCII characters, for example: "AB312". For 128 bit WEP key configurations, please insert 13 ASCII characters.</p> <p style="text-align: center;"> <input type="button" value="OK"/> <input type="button" value="Cancel"/> </p>			

Available settings are explained as follows:

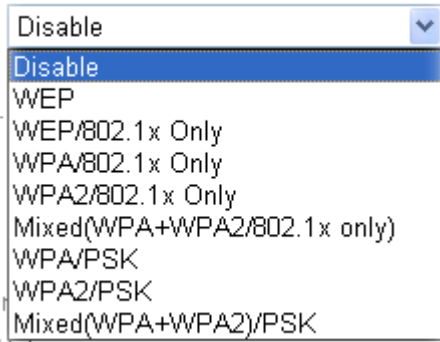
Item	Description
------	-------------

<p>Mode</p>	<p>There are several modes provided for you to choose.</p>  <p> Info You should also set RADIUS Server simultaneously if 802.1x mode is selected.</p> <p>Disable - Turn off the encryption mechanism.</p> <p>WEP - Accepts only WEP clients and the encryption key should be entered in WEP Key.</p> <p>WEP/802.1x Only - Accepts only WEP clients and the encryption key is obtained dynamically from RADIUS server with 802.1X protocol.</p> <p>WPA/802.1x Only - Accepts only WPA clients and the encryption key is obtained dynamically from RADIUS server with 802.1X protocol.</p> <p>WPA2/802.1x Only - Accepts only WPA2 clients and the encryption key is obtained dynamically from RADIUS server with 802.1X protocol.</p> <p>Mixed (WPA+WPA2/802.1x only) - Accepts WPA and WPA2 clients simultaneously and the encryption key is obtained dynamically from RADIUS server with 802.1X protocol.</p> <p>WPA/PSK - Accepts only WPA clients and the encryption key should be entered in PSK.</p> <p>WPA2/PSK - Accepts only WPA2 clients and the encryption key should be entered in PSK.</p> <p>Mixed (WPA+ WPA2)/PSK - Accepts WPA and WPA2 clients simultaneously and the encryption key should be entered in PSK.</p>
<p>WPA</p>	<p>The WPA encrypts each frame transmitted from the radio using the key, which either PSK (Pre-Shared Key) entered manually in this field below or automatically negotiated via 802.1x authentication. Either 8~63 ASCII characters, such as 012345678(or 64 Hexadecimal digits leading by 0x, such as "0x321253abcde...").</p> <p>Pre-Shared Key (PSK) - Either 8~63 ASCII characters, such as 012345678..(or 64 Hexadecimal digits leading by 0x, such as "0x321253abcde...").</p> <p>Password Strength - The system will display the password strength (represented with the word of weak, medium or strong) of the PSK specified above.</p>
<p>WEP</p>	<p>64-Bit - For 64 bits WEP key, either 5 ASCII characters, such as 12345 (or 10 hexadecimal digitals leading by 0x, such as 0x4142434445.)</p>

	<p>128-Bit - For 128 bits WEP key, either 13 ASCII characters, such as ABCDEFGHIJKLM (or 26 hexadecimal digits leading by 0x, such as 0x4142434445464748494A4B4C4D).</p> <p>Encryption Mode: 64-Bit ▾ 64-Bit 128-Bit</p> <p>All wireless devices must support the same WEP encryption bit size and have the same key. Four keys can be entered here, but only one key can be selected at a time. The keys can be entered in ASCII or Hexadecimal. Check the key you wish to use.</p>
--	--

After finishing all the settings here, please click OK to save the configuration.

III-1-4 Access Control

In the **Access Control**, the router may restrict wireless access to certain wireless clients only by locking their MAC address into a black or white list. The user may block wireless clients by inserting their MAC addresses into a black list, or only let them be able to connect by inserting their MAC addresses into a white list.

In the **Access Control** web page, users may configure the **white/black** list modes used by each SSID and the MAC addresses applied to their lists.

Wireless LAN >> Access Control

Access Control

Enable Mac Address Filter SSID 1 White List ▾ SSID 2 White List ▾
 SSID 3 White List ▾ SSID 4 White List ▾

MAC Address Filter(Limit: 64 entries)

Index	Attribute	MAC Address	Apply SSID	Comment
<div style="border: 1px solid gray; width: 100%; height: 100%;"></div>				

Client's MAC Address : : : : : :

Apply SSID : SSID 1 SSID 2 SSID 3 SSID 4

Attribute : s: Isolate the station from LAN

Comment :

Backup Access Control: Upload From File: 選擇檔案 未選擇任何檔案

Note:
Support AP ACL configuration file restoration.

Available settings are explained as follows:

Item	Description
Enable Mac Address Filter	Select to enable the MAC Address filter for wireless LAN identified with SSID 1 to 4 respectively. All the clients

	(expressed by MAC addresses) listed in the box can be grouped under different wireless LAN. For example, they can be grouped under SSID 1 and SSID 2 at the same time if you check SSID 1 and SSID 2.
MAC Address Filter	Display all MAC addresses that are edited before.
Client's MAC Address	Manually enter the MAC address of wireless client.
Apply SSID	After entering the client's MAC address, check the box of the SSIDs desired to insert this MAC address into their access control list.
Attribute	s: Isolate the station from LAN - select to isolate the wireless connection of the wireless client of the MAC address from LAN.
Comment	Enter a brief description for the specified client's MAC address.
Add	Add a new MAC address into the list.
Delete	Delete the selected MAC address in the list.
Edit	Edit the selected MAC address in the list.
Cancel	Give up the access control set up.
OK	Click it to save the access control list.
Clear All	Clean all entries in the MAC address list.
Backup Access Control	Settings on this web page can be saved as a file which can be restored in the future by this device or other device.
Upload From File	Restore wireless access control settings and applied onto this device.

After finishing all the settings here, please click **OK** to save the configuration.

III-1-5 WPS

Below shows Wireless LAN>>WPS web page:

Wireless LAN(2.4GHz) >> WPS (Wi-Fi Protected Setup)

Enable WPS 

Wi-Fi Protected Setup Information

WPS Status	Configured
SSID	DrayTek
Authentication Mode	Mixed(WPA+WPA2)/PSK

Device Configure

Configure via Push Button	<input type="button" value="Start PBC"/>
Configure via Client PinCode	<input type="text"/> <input type="button" value="Start PIN"/>

Status: Ready

Note:

WPS can help your wireless client automatically connect to the Access point.

: WPS is Disabled.

: WPS is Enabled.

: Waiting for WPS requests from wireless clients.

Available settings are explained as follows:

Item	Description
Enable WPS	Check this box to enable WPS setting.
WPS Status	Display related system information for WPS. If the wireless security (encryption) function of the router is properly configured, you can see 'Configured' message here.
SSID	Display the SSID1 of the router. WPS is supported by SSID1 only.
Authentication Mode	Display current authentication mode of the router. Only WPA2/PSK and WPA/PSK support WPS.
Configure via Push Button	Click Start PBC to invoke Push-Button style WPS setup procedure. The router will wait for WPS requests from wireless clients about two minutes. The WPS LED on the router will blink fast when WPS is in progress. It will return to normal condition after two minutes. (You need to setup WPS within two minutes)
Configure via Client PinCode	Please input the PIN code specified in wireless client you wish to connect, and click Start PIN button. The WPS LED on the router will blink fast when WPS is in progress. It will return to normal condition after two minutes. (You need to setup WPS within two minutes)

III-1-6 WDS

WDS means Wireless Distribution System. It is a protocol for connecting two access points (AP) wirelessly. Usually, it can be used for the following application:

- Provide bridge traffic between two LANs through the air.
- Extend the coverage range of a WLAN.

Refer to the following table:

WDS Mode	Wireless Signal	Comparisons
Bridge	Limited	<ul style="list-style-type: none"> • Wireless stations (clients) within the effective range of wireless signal can access into Internet through the router /AP. • Wireless stations (clients) out of the effective range of wireless signal cannot access into Internet through the router /AP with Bridge mode configured. • The packets received from a WDS link will only be forwarded to local wired or wireless hosts.
Repeater	Extended	<ul style="list-style-type: none"> • Wireless stations (clients) within the effective range of wireless signal can access into Internet through the router /AP. • Wireless stations (clients) out of the effective range of wireless signal can access into Internet through the router /AP with Repeater mode configured. • The packets received from one Vigor router can be repeated to another AP (remotely) through WDS links. • Only Repeater mode can do WDS-to-WDS packet forwarding.

The WDS - Repeater mode is implemented in Vigor router. The application for the WDS-Repeater mode is depicted as below:

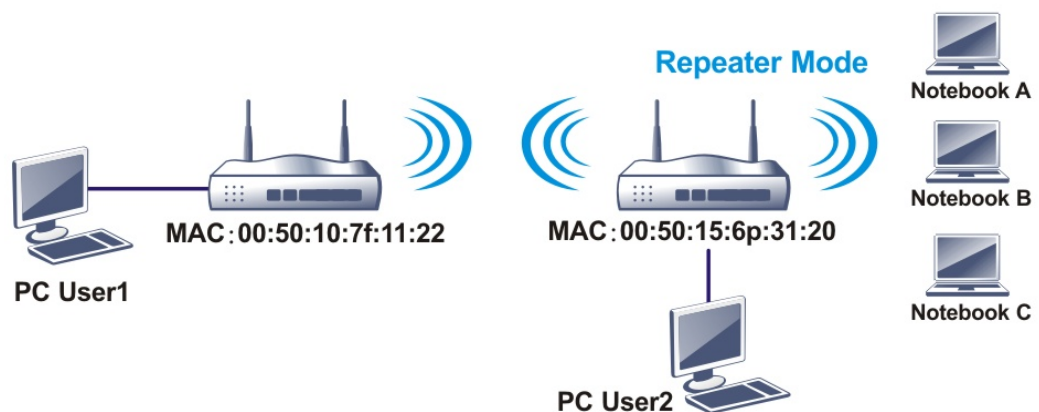

Click WDS from Wireless LAN menu. The following page will be shown.

WDS Settings
[Set to Factory Default](#)

<p>Mode: Disable ▾</p> <hr/> <p>Security:</p> <p> <input checked="" type="radio"/> Disable <input type="radio"/> WEP <input type="radio"/> Pre-shared Key </p> <hr/> <p>WEP:</p> <p>Use the same WEP key set in Security Settings.</p> <hr/> <p>Pre-shared Key:</p> <p>Type:</p> <p> <input type="radio"/> WPA <input checked="" type="radio"/> WPA2 </p> <p>Key: : Max: 66 characters</p> <hr/> <p>Note: WPA and WPA2 are not compatible with DrayTek WPA.</p> <p>Type 8~63 ASCII characters or 64 hexadecimal digits leading by "0x", for example "cfigs01a2..." or "0x655abcd....".</p>	<p>Bridge</p> <p>Enable <input type="checkbox"/></p> <p>Peer MAC Address</p> <p> <input type="text"/> : <input type="text"/> : <input type="text"/> : <input type="text"/> : <input type="text"/> : <input type="text"/> </p> <p> <input type="text"/> : <input type="text"/> : <input type="text"/> : <input type="text"/> : <input type="text"/> : <input type="text"/> </p> <p> <input type="text"/> : <input type="text"/> : <input type="text"/> : <input type="text"/> : <input type="text"/> : <input type="text"/> </p> <p> <input type="text"/> : <input type="text"/> : <input type="text"/> : <input type="text"/> : <input type="text"/> : <input type="text"/> </p> <p>Note: Disable unused links to get better performance.</p> <hr/> <p>Repeater</p> <p>Enable <input type="checkbox"/></p> <p>Peer MAC Address</p> <p> <input type="text"/> : <input type="text"/> : <input type="text"/> : <input type="text"/> : <input type="text"/> : <input type="text"/> </p> <p> <input type="text"/> : <input type="text"/> : <input type="text"/> : <input type="text"/> : <input type="text"/> : <input type="text"/> </p> <p> <input type="text"/> : <input type="text"/> : <input type="text"/> : <input type="text"/> : <input type="text"/> : <input type="text"/> </p> <p> <input type="text"/> : <input type="text"/> : <input type="text"/> : <input type="text"/> : <input type="text"/> : <input type="text"/> </p> <hr/> <p>Access Point Function:</p> <p> <input checked="" type="radio"/> Enable <input type="radio"/> Disable </p> <hr/> <p>Status:</p> <p><input type="checkbox"/> Send "Hello" message to peers.</p> <p style="text-align: center;">Link Status</p> <p>Note: The status is valid only when the peer also supports this function.</p>
---	--

OK
Cancel

Available settings are explained as follows:

Item	Description
Mode	Choose the mode for WDS setting. Disable mode will not invoke any WDS setting. Repeater mode is for the second one.
Security	There are three types for security, Disable , WEP and Pre-shared key . The setting you choose here will make the following WEP or Pre-shared key field valid or not. Choose one of the types for the router.
Pre-shared Key	When Pre-Shared Key is selected as Security above, configure the following settings if required. Type - There are some types for you to choose. WPA and WPA2 are used for WDS devices (e.g.2925n wireless router, you can set the encryption mode as WPA or WPA2 to establish your WDS system between AP and the router. Key - Set the encryption key in this field. Type 8 ~ 63 ASCII characters or 64 hexadecimal digits leading by "0x".
Bridge	If you choose Bridge as the connecting mode, please Enter the peer MAC address in these fields. Four peer MAC addresses are allowed to be entered in this page at one time. Yet please disable the unused link to get better

	performance. If you want to invoke the peer MAC address, remember to check Enable box in the front of the MAC address after typing.
Repeater	<p>If you choose Repeater as the connecting mode, please Enter the peer MAC address (of VigorAP/Vigor router required to make connection with such Vigor router and used to extend the wireless signal) in these fields.</p> <p>Four peer MAC addresses are allowed to be entered in this page at one time. Similarly, if you want to invoke the peer MAC address, remember to check Enable box in the front of the MAC address after typing.</p>
Access Point Function	<p>Click Enable to make this router serve as an access point. When Repeater is set as WDS Mode, click Enable to use such function.</p> <p>Click Disable if Bridge is set as WDS Mode.</p>
Status	It allows user to send "hello" message to peers. Yet, it is valid only when the peer also supports this function.

After finishing all the settings here, please click **OK** to save the configuration.

III-1-7 Advanced Setting

This page allows users to set advanced settings such as operation mode, channel bandwidth, guard interval, and aggregation MSDU for wireless data transmission.

Wireless LAN >> Advanced Setting

HT Physical Mode

Operation Mode	<input checked="" type="radio"/> Mixed Mode <input type="radio"/> Green Field
Channel Bandwidth	<input type="radio"/> 20 <input checked="" type="radio"/> 20/40 <input type="radio"/> 40
Guard Interval	<input type="radio"/> long <input checked="" type="radio"/> auto
Aggregation MSDU(A-MSDU)	<input checked="" type="radio"/> Enable <input type="radio"/> Disable
Long Preamble	<input type="radio"/> Enable <input checked="" type="radio"/> Disable
Packet-OVERDRIVE™ TX Burst	<input type="radio"/> Enable <input checked="" type="radio"/> Disable
Tx Power	<input checked="" type="radio"/> 100% <input type="radio"/> 80% <input type="radio"/> 60% <input type="radio"/> 30% <input type="radio"/> 20% <input type="radio"/> 10%
WMM Capable	<input checked="" type="radio"/> Enable <input type="radio"/> Disable
APSD Capable	<input type="radio"/> Enable <input checked="" type="radio"/> Disable
Rate Adaptation Algorithm	<input checked="" type="radio"/> New <input type="radio"/> Old
Fragment Length (256 - 2346)	<input type="text" value="2346"/> bytes
RTS Threshold (1 - 2347)	<input type="text" value="2347"/> bytes
Country Code	<input type="text"/> (Reference)

OK

Available settings are explained as follows:

Item	Description
Operation Mode	<p>Mixed Mode - the router can transmit data with the ways supported in both 802.11a/b/g and 802.11n standards. However, the entire wireless transmission will be slowed down if 802.11g or 802.11b wireless client is connected.</p> <p>Green Field - to get the highest throughput, please choose such mode. Such mode can make the data transmission happen between 11n systems only. In addition, it does not have protection mechanism to avoid the conflict with neighboring devices of 802.11a/b/g.</p>
Channel Bandwidth	<p>Vigor router will use 20MHz/40MHz/80MHz for data transmission and receiving between the AP and the stations.</p> <p>20/40- Vigor Router will scan for nearby wireless AP, and then use 20MHz if the number of AP is more than 10, or use 40MHz if it's not.</p>
Guard Interval	<p>It is to assure the safety of propagation delays and reflections for the sensitive digital data. If you choose auto as guard interval, the AP router will choose short guard interval (increasing the wireless performance) or long guard interval for data transmit based on the station capability.</p>
Aggregation MSDU	<p>Aggregation MSDU can combine frames with different sizes. It is used for improving MAC layer's performance for some brand's clients. The default setting is Enable.</p>
Long Preamble	<p>This option is to define the length of the sync field in an 802.11 packet. Most modern wireless network uses short preamble with 56 bit sync field instead of long preamble with</p>

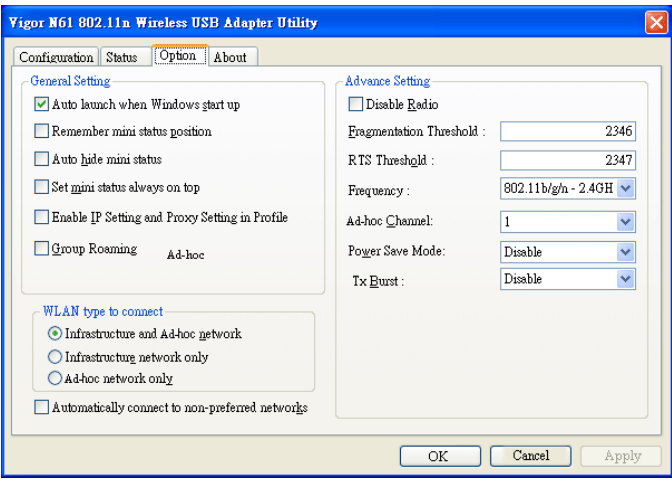
	128 bit sync field. However, some original 11b wireless network devices only support long preamble. Click Enable to use Long Preamble if needed to communicate with this kind of devices.
Packet-OVERDRIVE TX Burst	<p>This feature can enhance the performance in data transmission about 40%* more (by checking Tx Burst). It is active only when both sides of Access Point and Station (in wireless client) invoke this function at the same time. That is, the wireless client must support this feature and invoke the function, too.</p> <p>Note: Vigor N61 wireless adapter supports this function. Therefore, you can use and install it into your PC for matching with Packet-OVERDRIVE (refer to the following picture of Vigor N61 wireless utility window, choose Enable for TxBURST on the tab of Option).</p> 
TX Power	Set the power percentage for transmission signal of access point. The greater the value is, the higher intensity of the signal will be.
WMM Capable	<p>WMM is an abbreviation of Wi-Fi Multimedia. It defines the priority levels for four access categories derived from 802.1d (prioritization tabs). The categories are designed with specific types of traffic, voice, video, best effort and low priority data. There are four accessing categories - AC_BE , AC_BK, AC_VI and AC_VO for WMM.</p> <p>To apply WMM parameters for wireless data transmission, please click the Enable radio button.</p>
APSD Capable	<p>APSD (automatic power-save delivery) is an enhancement over the power-save mechanisms supported by Wi-Fi networks. It allows devices to take more time in sleeping state and consume less power to improve the performance by minimizing transmission latency.</p> <p>The default setting is Disable.</p>
Rate Adaptation Algorithm	Wireless transmission rate is adapted dynamically. Usually, performance of "new" algorithm is better than "old".
Fragment Length (256 - 2346)	Set the Fragment threshold. Do not modify default value if you don't know what it is, default value is 2346.
RTS Threshold (1 - 2347)	<p>Minimize the collision (unit is bytes) between hidden stations to improve wireless performance.</p> <p>Set the RTS threshold. Do not modify default value if you</p>

	don't know what it is, default value is 2347.
Country Code	Vigor router broadcasts country codes by following the 802.11d standard. However, some wireless stations will detect / scan the country code to prevent conflict occurred. If conflict is detected, wireless station will be warned and is unable to make network connection. Therefore, changing the country code to ensure successful network connection will be necessary for some clients.

After finishing all the settings here, please click **OK** to save the configuration.

III-1-8 AP Discovery

Vigor router can scan all regulatory channels and find working APs in the neighborhood. Based on the scanning result, users will know which channel is clean for usage. Also, it can be used to facilitate finding an AP for a WDS link. Notice that during the scanning process (about 5 seconds), no client is allowed to connect to Vigor.

This page is used to scan the existence of the APs on the wireless LAN. Yet, only the AP which is in the same channel of this router can be found. Please click **Scan** to discover all the connected APs.

Wireless LAN >> Access Point Discovery

Access Point List

Index	BSSID	Channel	RSSI	SSID	Authentication

See [Statistics](#).

Add to WDS Settings :

AP's MAC address

Bridge Repeater

Note:

1. During the scanning process (~5 seconds), no station is allowed to connect with the router.
2. AP Discovery can only support up to 32 APs displayed on the screen.

Available settings are explained as follows:

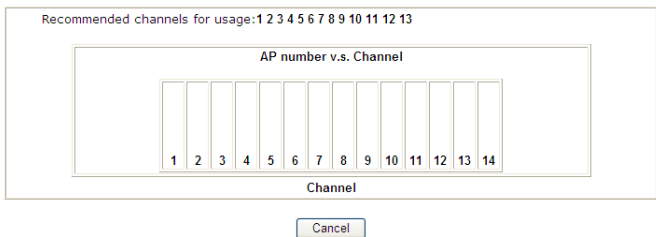
Item	Description
Scan	It is used to discover all the connected AP. The results will be shown on the box above this button.
Statistics	<p>It displays the statistics for the channels used by APs.</p> <p>Wireless LAN >> Site Survey Statistics</p> 
Add to	If you want the found AP applying the WDS settings, please Enter the AP's MAC address on the bottom of the page and click Repeater. Next, click Add to . Later, the MAC address of the AP will be added to Bridge or Repeater field of WDS settings page.

III-1-9 Station List

Station List provides the knowledge of connecting wireless clients now along with its status code. There is a code summary below for explanation. For convenient **Access Control**, you can select a WLAN station and click **Add to Access Control** below.

Wireless LAN >> Station List

Station List

General Advanced

Index	Status	IP Address	MAC Address	Associated with
<div style="text-align: center; margin-top: 10px;"> <input type="button" value="Refresh"/> </div>				

Status Codes :
 C: Connected, No encryption.
 E: Connected, WEP.
 P: Connected, WPA.
 A: Connected, WPA2.
 B: Blocked by Access Control.
 N: Connecting.
 F: Fail to pass WPA/PSK authentication.

Add to Access Control :

Client's MAC address : : : : :

Note:

After a station connects to the router successfully, it may be turned off without notice. In that case, it will still be on the list until the connection expires.

Available settings are explained as follows:

Item	Description
Refresh	Click this button to refresh the status of station list.
Add	Click this button to add current typed MAC address into Access Control.

This page is left blank.

Part IV VPN



VPN



SSL VPN



Certificate
Management

A Virtual Private Network (VPN) is the extension of a private network that encompasses links across shared or public networks like the Internet. In short, by VPN technology, you can send data between two computers across a shared or public network in a manner that emulates the properties of a point-to-point private link.

It is a form of VPN that can be used with a standard Web browser.

A digital certificate works as an electronic ID, which is issued by a certification authority (CA). It contains information such as your name, a serial number, expiration dates etc., and the digital signature of the certificate-issuing authority so that a recipient can verify that the certificate is real. Here Vigor router support digital certificates conforming to standard X.509.

IV-1 VPN and Remote Access

A Virtual Private Network (VPN) is the extension of a private network that encompasses links across shared or public networks like the Internet. In short, by VPN technology, you can send data between two computers across a shared or public network in a manner that emulates the properties of a point-to-point private link.

The VPN built is suitable for:

- Communication between home office and customer
- Secure connection between Teleworker, staff on business trip and main office
- Exchange data between remote office and main office
- POS between chain store and headquarters

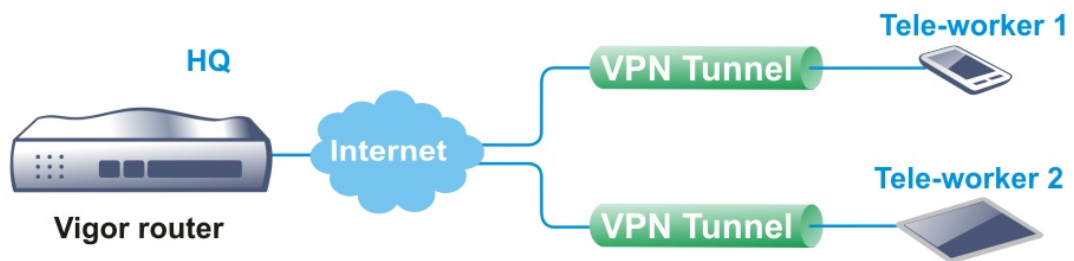

Site-to-Site (LAN-to-LAN)

- A connection between two router's LAN networks.
- Allows employees in branch offices and head office to share the same network resources.

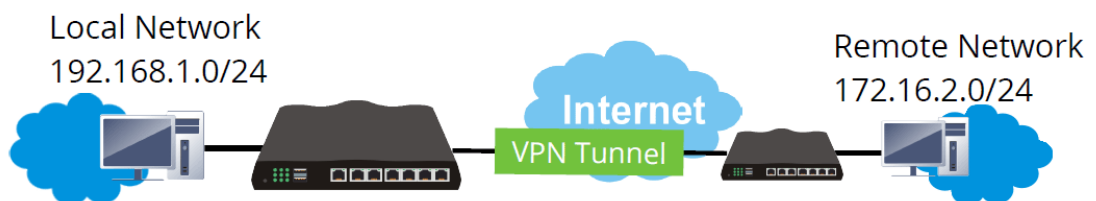

Remote Access (Remote Dial-in)

- A connection between the remote host and router's LAN network. The host will use an IP address in the local subnet.
- Allows employees to access the company's internal resources when they are traveling.

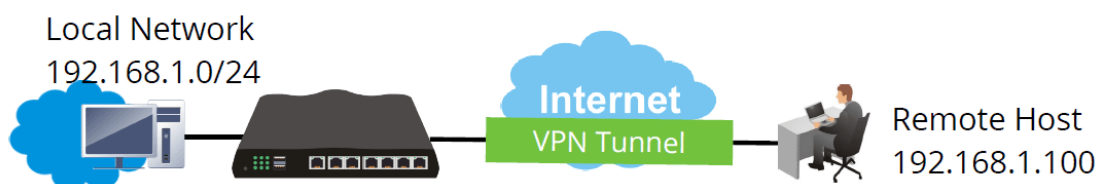

Web User Interface

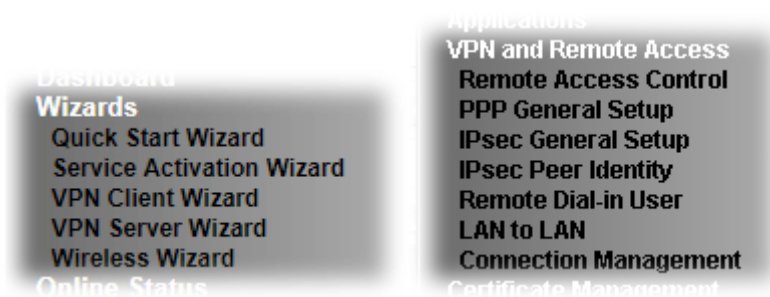

IV-1-1 VPN Client Wizard

Such wizard is used to configure VPN settings for VPN client. Such wizard will guide to set the LAN-to-LAN profile for VPN dial out connection (from server to client) step by step.

1. Open **Wizards>>VPN Client Wizard**. The following page will appear.

VPN Client Wizard

Choose VPN Establishment Environment

LAN-to-LAN VPN Client Mode Selection:

Please choose a LAN-to-LAN Profile:

Note:

1. Please use Route Mode for typical LAN-to-LAN tunnels.
2. If the remote network is only expecting a single client or IP and is not configured to route the subnet then select NAT Mode.
3. If you are unsure of your configuration select Route Mode.

Available settings are explained as follows:

Item	Description
LAN-to-LAN Client Mode Selection	Choose the client mode. Route Mode/NAT Mode - If the remote network only allows you to dial in with single IP, please choose NAT mode, otherwise please choose Route Mode.
Please choose a LAN-to-LAN Profile	There are 32 VPN profiles for users to set.

- When you finish the mode and profile selection, please click **Next** to open the following page.

VPN Client Wizard

VPN Connection Setting

<p>Security Ranking:</p> <p>Very High L2TP over IPSec</p> <p>High IPSec / SSL</p> <p>Medium PPTP (Encryption)</p> <p>Low L2TP / PPTP (None Encryption)</p>	<p>Throughput Ranking:</p> <p>Very High L2TP / PPTP (None Encryption)</p> <p>High IPSec</p> <p>Medium L2TP over IPSec / PPTP (Encryption)</p> <p>Low SSL</p>
<p>Select VPN Type:</p> <div style="border: 1px solid black; padding: 2px;"> <p>PPTP (Encryption) ▾</p> <p>PPTP (None Encryption)</p> <p>PPTP (Encryption)</p> <p>IPsec</p> <p>L2TP</p> <p>L2TP over IPsec (Nice to Have)</p> <p>L2TP over IPsec (Must)</p> <p>SSL</p> </div>	
<p> <input style="margin-right: 10px;" type="button" value=" < Back "/> <input style="margin-right: 10px;" type="button" value=" Next > "/> <input style="margin-right: 10px;" type="button" value=" Finish "/> <input style="margin-right: 10px;" type="button" value=" Cancel "/> </p>	

In this page, you have to select suitable VPN type for the VPN client profile. There are six types provided here. Different type will lead to different configuration page. After making the choices for the client profile, please click **Next**. You will see different configurations based on the selection(s) you made.



Info

The following descriptions for VPN Type are based on the Route Mode specified in LAN-to-LAN Client Mode Selection.

When you choose **PPTP (None Encryption)** or **PPTP (Encryption)**, you will see the following graphic:

VPN Client Wizard

VPN Client PPTP None Encryption Settings

Profile Name	???
VPN Dial-Out Through	WAN1 First
<input type="checkbox"/> Always on	
Server IP/Host Name for VPN (e.g. draytek.com or 123.45.67.89)	
Username	???
Password	
Remote Network IP	0.0.0.0
Remote Network Mask	255.255.255.0 / 24
Local Network IP	192.168.1.1
Local Network Mask	255.255.255.0 / 24

< Back Next > Finish Cancel

When you choose IPsec, you will see the following graphic:

VPN Client Wizard

VPN Client IPsec Settings

Profile Name	???
VPN Dial-Out Through	WAN1 First
<input type="checkbox"/> Always on	
Server IP/Host Name for VPN (e.g. draytek.com or 123.45.67.89)	
IKE Authentication Method	
<input checked="" type="radio"/> Pre-Shared Key	
Confirm Pre-Shared Key	
<input type="radio"/> Digital Signature (X.509)	
Peer ID	None
Local ID	
<input checked="" type="radio"/> Alternative Subject Name First	
<input type="radio"/> Subject Name First	
Local Certificate	None
IPsec Security Method	
<input type="radio"/> Medium (AH)	
<input checked="" type="radio"/> High (ESP)	AES with Authentication
Remote Network IP	0.0.0.0
Remote Network Mask	255.255.255.0 / 24
Local Network IP	192.168.1.1
Local Network Mask	255.255.255.0 / 24

< Back Next > Finish Cancel

When you choose SSL, you will see the following graphic:

VPN Client Wizard

Profile Name	???
VPN Dial-Out Through	WAN1 First ▼
<input type="checkbox"/> Always on	
Server IP/Host Name for VPN (e.g. draytek.com or 123.45.67.89)	
Server Port (for SSL Tunnel):	443
Username	???
Password	
Remote Network IP	0.0.0.0
Remote Network Mask	255.255.255.0 / 24 ▼
Local Network IP	192.168.1.1
Local Network Mask	255.255.255.0 / 24 ▼

When you choose L2TP over IPsec (Nice to Have) or L2TP over IPsec (Must), you will see the following graphic:

VPN Client Wizard

VPN Client L2TP over IPsec (Nice to Have) Settings

Profile Name	???
VPN Dial-Out Through	WAN1 First ▼
<input type="checkbox"/> Always on	
Server IP/Host Name for VPN (e.g. draytek.com or 123.45.67.89)	
IKE Authentication Method	
<input checked="" type="radio"/> Pre-Shared Key	
Confirm Pre-Shared Key	
<input type="radio"/> Digital Signature (X.509)	
Peer ID	None ▼
Local ID	
<input checked="" type="radio"/> Alternative Subject Name First	
<input type="radio"/> Subject Name First	
Local Certificate	None ▼
IPsec Security Method	
<input type="radio"/> Medium (AH)	
<input checked="" type="radio"/> High (ESP)	
Authentication Method	AES with Authentication ▼
Username	???
Password	
Remote Network IP	0.0.0.0
Remote Network Mask	255.255.255.0 / 24 ▼
Local Network IP	192.168.1.1
Local Network Mask	255.255.255.0 / 24 ▼

Available settings are explained as follows:

Item	Description
Profile Name	Type a name for such profile. The length of the file is limited

	to 10 characters.
Always On	Check to enable router always keep VPN connection.
Server IP/Host Name for VPN	Enter the IP address of the server or Enter the host name for such VPN profile.
IKE Authentication Method	IKE Authentication Method usually applies to those are remote dial-in user or node (LAN to LAN) which uses dynamic IP address and IPsec-related VPN connections such as L2TP over IPsec and IPsec tunnel. Pre-Shared Key- Specify a key for IKE authentication. Confirm Pre-Shared Key- Confirm the pre-shared key.
Digital Signature (X.509)	Click Digital Signature to invoke this function. Peer ID - Choose the peer ID selection from the drop down list. Local ID - Choose Alternative Subject Name First or Subject Name First . Local Certificate - Use the drop down list to choose one of the certificates for using. You have to configure one certificate at least previously in Certificate Management >> Local Certificate . Otherwise, the setting you choose here will not be effective.
IPsec Security Method	Medium - Authentication Header (AH) means data will be authenticated, but not be encrypted. By default, this option is active. High - Encapsulating Security Payload (ESP) means payload (data) will be encrypted and authenticated. You may select encryption algorithm from Data Encryption Standard (DES), Triple DES (3DES), and AES.
User Name	This field is used to authenticate for connection when you select PPTP or L2TP with or without IPsec policy above. The length of the user name is limited to 11 characters.
Password	This field is used to authenticate for connection when you select PPTP or L2TP with or without IPsec policy above. The length of the password is limited to 11 characters.
Remote Network IP	Please type one LAN IP address (according to the real location of the remote host) for building VPN connection.
Remote Network Mask	Please Enter the network mask (according to the real location of the remote host) for building VPN connection.
Local Network IP	Enter the local network IP for TCP / IP configuration.
Local Network Mask	Enter the local network mask for TCP / IP configuration.

- After finishing the configuration, please click **Next**. The confirmation page will be shown as follows. If there is no problem, you can click one of the radio buttons listed on the page and click **Finish** to execute the next action.

VPN Client Wizard

Please confirm your settings

LAN-to-LAN Index:	3
Profile Name:	test
VPN Connection Type:	L2TP over IPsec (Nice to Have)
VPN Dial-Out Through:	WAN1 First
Always on:	No
Server IP/Host Name:	192.168.1.86
IKE Authentication Method:	Pre-Shared Key
IPsec Security Method:	AES with Authentication
Remote Network IP:	192.168.1.99
Remote Network Mask:	255.255.255.0
Local Network IP:	192.168.1.1
Local Network Mask:	255.255.255.0

Click **Back** to modify changes if necessary. Otherwise,click **Finish** to save the current settings and proceed to the following action:

- Go to the VPN Connection Management.
- Do another VPN Client Wizard setup.
- View more detailed configurations.

< Back

Next >

Finish

Cancel

Available settings are explained as follows:

Item	Description
Go to the VPN Connection Management	Click this radio button to access VPN and Remote Access>>Connection Management for viewing VPN Connection status.
Do another VPN Server Wizard Setup	Click this radio button to set another profile of VPN Server through VPN Server Wizard.
View more detailed configuration	Click this radio button to access VPN and Remote Access>>LAN to LAN for viewing detailed configuration.

IV-1-2 VPN Server Wizard

Such wizard is used to configure VPN settings for VPN server. Such wizard will guide to set the LAN-to-LAN profile for VPN dial in connection (from client to server) step by step.

1. Open Wizards>>VPN Server Wizard. The following page will appear.

VPN Server Wizard

Choose VPN Establishment Environment

VPN Server Mode Selection: Remote Dial-in User (Teleworker) ▼

Please choose a LAN-to-LAN Profile: [Index] [Status] [Name] ▼

Please choose a Dial-in User Accounts: 8 x ??? ▼

Allowed Dial-in Type:

- PPTP
- IPsec
- L2TP with IPsec Policy None ▼
- SSL Tunnel

< Back
Next >
Finish
Cancel

Available settings are explained as follows:

Item	Description
VPN Server Mode Selection	Choose the direction for the VPN server. Site to Site VPN - To set a LAN-to-LAN profile automatically, please choose Site to Site VPN. Remote Dial-in User -You can manage remote access by maintaining a table of remote user profile, so that users can be authenticated to dial-in via VPN connection.
Please choose a LAN-to-LAN Profile	This item is available when you choose Site to Site VPN (LAN-to-LAN) as VPN server mode. There are 32 VPN profiles for users to set.
Please choose a Dial-in User Accounts	This item is available when you choose Remote Dial-in User (Teleworker) as VPN server mode. There are 32 VPN tunnels for users to set.
Allowed Dial-in Type	This item is available after you choose any one of dial-in user account profiles. Next, you have to select suitable dial-in type for the VPN server profile. There are several types provided here (similar to VPN Client Wizard).

	<input checked="" type="checkbox"/> PPTP <input checked="" type="checkbox"/> IPsec <input checked="" type="checkbox"/> L2TP with IPsec Policy <input checked="" type="checkbox"/> SSL Tunnel
--	---

None
None
Nice to Have
Must

Different Dial-in Type will lead to different configuration page. In addition, adjustable items for each dial-in type will be changed according to the VPN Server Mode (Site to Site VPN and Remote Dial-in User) selected.

- After making the choices for the server profile, please click **Next**. You will see different configurations based on the selection you made. Here we take the examples of choosing **Site-to-Site VPN** as the **VPN Server Mode**.

When you check PPTP/SSL, you will see the following graphic:

VPN Server Wizard

VPN Authentication Setting

Profile Name	<input style="width: 100%;" type="text" value="???"/>
PPTP / L2TP / L2TP over IPsec / SSL Tunnel Authentication	
Username	<input style="width: 100%;" type="text" value="???"/>
Password	<input style="width: 100%;" type="password"/>
Peer IP/VPN Client IP	<input style="width: 100%;" type="text"/>
Site to Site Information	
Remote Network IP	<input style="width: 100%;" type="text" value="0.0.0.0"/>
Remote Network Mask	<input style="width: 100%;" type="text" value="255.255.255.0 / 24"/>
Local Network IP	<input style="width: 100%;" type="text" value="192.168.1.1"/>
Local Network Mask	<input style="width: 100%;" type="text" value="255.255.255.0 / 24"/>

When you check **PPTP & IPsec & L2TP** (three types) or **PPTP & IPsec** (two types) or **L2TP with Policy (Nice to Have/Must)**, you will see the following graphic:

VPN Server Wizard

VPN Authentication Setting

Profile Name	???
PPTP / L2TP / L2TP over IPsec / SSL Tunnel Authentication	
Username	???
Password	
IPsec / L2TP over IPsec Authentication	
<input checked="" type="checkbox"/> Pre-Shared Key	
Confirm Pre-Shared Key	
<input type="checkbox"/> Digital Signature (X.509)	
Peer ID	None
Local ID	
<input checked="" type="radio"/> Alternative Subject Name First	
<input type="radio"/> Subject Name First	
Peer IP/VPN Client IP	
Peer ID	
Site to Site Information	
Remote Network IP	0.0.0.0
Remote Network Mask	255.255.255.0 / 24
Local Network IP	192.168.1.1
Local Network Mask	255.255.255.0 / 24

When you check IPsec, you will see the following graphic:

VPN Server Wizard

VPN Authentication Setting

Profile Name	???
IPsec / L2TP over IPsec Authentication	
<input checked="" type="checkbox"/> Pre-Shared Key	
Confirm Pre-Shared Key	
<input type="checkbox"/> Digital Signature (X.509)	
Peer ID	None
Local ID	
<input checked="" type="radio"/> Alternative Subject Name First	
<input type="radio"/> Subject Name First	
Peer IP/VPN Client IP	
Peer ID	
Site to Site Information	
Remote Network IP	0.0.0.0
Remote Network Mask	255.255.255.0 / 24
Local Network IP	192.168.1.1
Local Network Mask	255.255.255.0 / 24

Available settings are explained as follows:

Item	Description
Profile Name	Type a name for such profile. The length of the file is limited to 10 characters.
User Name	This field is used to authenticate for connection when you select PPTP or L2TP with or without IPsec policy above. The length of the name is limited to 11 characters.

Password	This field is used to authenticate for connection when you select PPTP or L2TP with or without IPsec policy above. The length of the name is limited to 11 characters.
Pre-Shared Key	For IPsec/L2TP IPsec authentication, you have to type a pre-shared key. The length of the name is limited to 64 characters.
Confirm Pre-Shared Key	Enter the pre-shared key again for confirmation.
Digital Signature (X.509)	Check the box of Digital Signature to invoke this function. Peer ID - Choose the peer ID selection from the drop down list. Local ID - Choose Alternative Subject Name First or Subject Name First .
Peer IP/VPN Client IP	Enter the WAN IP address or VPN client IP address for the remote client.
Peer ID	Enter the ID name for the remote client. The length of the name is limited to 47 characters.
Remote Network IP	Please type one LAN IP address (according to the real location of the remote host) for building VPN connection.
Remote Network Mask	Please Enter the network mask (according to the real location of the remote host) for building VPN connection.
Local Network IP	Enter the local network IP for TCP / IP configuration.
Local Network Mask	Enter the local network mask for TCP / IP configuration.

- After finishing the configuration, please click **Next**. The confirmation page will be shown as follows. If there is no problem, you can click one of the radio buttons listed on the page and click **Finish** to execute the next action.

VPN Server Wizard

Please Confirm Your Settings

VPN Environment:	Site to Site VPN (LAN-to-LAN)
Index:	3
Profile Name:	???
Username:	???
Allowed Service:	IPsec
Peer IP/VPN Client IP:	172.16.3.8
Peer ID:	ID12345678
Remote Network IP:	172.16.3.99
Remote Network Mask:	255.255.255.0
Local Network IP:	192.168.1.1
Local Network Mask:	255.255.255.0

Click **Back** to modify changes if necessary. Otherwise, click **Finish** to save the current settings and proceed to the following action:

Go to the VPN Connection Management.
 Do another VPN Server Wizard setup.
 View more detailed configurations.

Available settings are explained as follows:

Item	Description
Go to the VPN Connection Management	Click this radio button to access VPN and Remote Access>>Connection Management for viewing VPN Connection status.
Do another VPN Server Wizard Setup	Click this radio button to set another profile of VPN Server through VPN Server Wizard.
View more detailed configuration	Click this radio button to access VPN and Remote Access>>LAN to LAN for viewing detailed configuration.

IV-1-3 Remote Access Control

Enable the necessary VPN service as you need. If you intend to run a VPN server inside your LAN, you should disable the VPN service of Vigor Router to allow VPN tunnel pass through, as well as the appropriate NAT settings, such as DMZ or open port.

Open **VPN and Remote Access>>Remote Access Control**.

VPN and Remote Access >> Remote Access Control Setup

Remote Access Control Setup

<input checked="" type="checkbox"/>	Enable PPTP VPN Service
<input checked="" type="checkbox"/>	Enable IPSec VPN Service
<input checked="" type="checkbox"/>	Enable L2TP VPN Service
<input checked="" type="checkbox"/>	Enable SSL VPN Service

Note:

To allow VPN pass-through to a separate VPN server on the LAN, disable any services above that use the same protocol and ensure that NAT **Open Ports** or **Port Redirection** is also configured.

After finishing all the settings here, please click **OK** to save the configuration.

IV-1-4 PPP General Setup

This submenu only applies to PPP-related VPN connections, such as PPTP, L2TP, L2TP over IPsec.

VPN and Remote Access >> PPP General Setup

PPP General Setup

<p>PPP/MP Protocol</p> <p>Dial-In PPP Authentication: <input type="text" value="PAP/CHAP/MS-CHAP/MS-CHAPv2"/></p> <p>Dial-In PPP Encryption(MPPE): <input type="text" value="Optional MPPE"/></p> <p>Mutual Authentication (PAP): <input type="radio"/> Yes <input checked="" type="radio"/> No</p> <p>Username: <input type="text" value="Max: 23 characters"/></p> <p>Password: <input type="text" value="Max: 19 characters"/></p> <p>IP Address Assignment for Dial-In Users (When DHCP Disable set)</p> <table border="1"> <thead> <tr> <th></th> <th>Start IP Address</th> <th>IP Pool Counts</th> </tr> </thead> <tbody> <tr> <td>LAN 1</td> <td><input type="text" value="192.168.1.200"/></td> <td><input type="text" value="50"/></td> </tr> <tr> <td>LAN 2</td> <td><input type="text" value="192.168.2.200"/></td> <td><input type="text" value="50"/></td> </tr> </tbody> </table>		Start IP Address	IP Pool Counts	LAN 1	<input type="text" value="192.168.1.200"/>	<input type="text" value="50"/>	LAN 2	<input type="text" value="192.168.2.200"/>	<input type="text" value="50"/>	<p>PPP Authentication Methods</p> <p><input checked="" type="checkbox"/> Remote Dial-in User</p> <p><input checked="" type="checkbox"/> RADIUS</p> <p>Note:</p> <ol style="list-style-type: none"> 1. Default priority is Remote Dial-in User -> RADIUS. 2. Vigor router also supports Frame-IP-Address from RADIUS server to assign IP address to VPN client. <p>While using Radius Authentication:</p> <p>Assign IP from subnet: <input type="text" value="LAN1"/></p>
	Start IP Address	IP Pool Counts								
LAN 1	<input type="text" value="192.168.1.200"/>	<input type="text" value="50"/>								
LAN 2	<input type="text" value="192.168.2.200"/>	<input type="text" value="50"/>								

Available settings are explained as follows:

Item	Description
Dial-In PPP Authentication	<p>PAP Only - elect this option to force the router to authenticate dial-in users with the PAP protocol.</p> <p>PAP/CHAP/MS-CHAP/MS-CHAPv2 - Selecting this option means the router will attempt to authenticate dial-in users with the CHAP protocol first. If the dial-in user does not support this protocol, it will fall back to use the PAP protocol for authentication.</p>
Dial-In PPP Encryption (MPPE)	<p>Optional MPPE - This option represents that the MPPE encryption method will be optionally employed in the router for the remote dial-in user. If the remote dial-in user does not support the MPPE encryption algorithm, the router will transmit "no MPPE encrypted packets". Otherwise, the MPPE encryption scheme will be used to encrypt the data.</p> <ul style="list-style-type: none"> ● Require MPPE (40/128bits) - Selecting this option will force the router to encrypt packets by using the MPPE encryption algorithm. In addition, the remote dial-in user will use 40-bit to perform encryption prior to using 128-bit for encryption. In other words, if 128-bit MPPE encryption method is not available, then 40-bit encryption scheme will be applied to encrypt the data. ● Maximum MPPE - This option indicates that the router will use the MPPE encryption scheme with maximum bits (128-bit) to encrypt the data.
Mutual Authentication (PAP)	<p>The Mutual Authentication function is mainly used to communicate with other routers or clients who need bi-directional authentication in order to provide stronger security, for example, Cisco routers. So you should enable this function when your peer router requires mutual</p>

	<p>authentication. You should further specify the User Name and Password of the mutual authentication peer.</p> <p>The length of the name/password is limited to 23/19 characters.</p>
IP Address Assignment for Dial-In Users	<p>Enter a start IP address for the dial-in PPP connection. You should choose an IP address from the local private network. For example, if the local private network is 192.168.1.0/255.255.255.0, you could choose 192.168.1.200 as the Start IP Address.</p> <p>You can configure up to four start IP addresses for LAN1 ~ LAN4.</p>
PPP Authentication Methods	<p>Select the method(s) to be used for authentication in PPP connection.</p> <p>PPP Authentication Methods</p> <ul style="list-style-type: none"> <input checked="" type="checkbox"/> Remote Dial-in User <input checked="" type="checkbox"/> RADIUS
While using Radius Authentication	<p>If PPP connection will be authenticated via RADIUS server, it is necessary to specify the LAN profile for the dial-in user to get IP from.</p>

IV-1-5 IPsec General Setup

In IPsec General Setup, there are two major parts of configuration.

There are two phases of IPsec.

- Phase 1: negotiation of IKE parameters including encryption, hash, Diffie-Hellman parameter values, and lifetime to protect the following IKE exchange, authentication of both peers using either a Pre-Shared Key or Digital Signature (x.509). The peer that starts the negotiation proposes all its policies to the remote peer and then remote peer tries to find a highest-priority match with its policies. Eventually to set up a secure tunnel for IKE Phase 2.
- Phase 2: negotiation IPsec security methods including Authentication Header (AH) or Encapsulating Security Payload (ESP) for the following IKE exchange and mutual examination of the secure tunnel establishment.

There are two encapsulation methods used in IPsec, **Transport** and **Tunnel**. The **Transport** mode will add the AH/ESP payload and use original IP header to encapsulate the data payload only. It can just apply to local packet, e.g., L2TP over IPsec. The **Tunnel** mode will not only add the AH/ESP payload but also use a new IP header (Tunneled IP header) to encapsulate the whole original IP packet.

Authentication Header (AH) provides data authentication and integrity for IP packets passed between VPN peers. This is achieved by a keyed one-way hash function to the packet to create a message digest. This digest will be put in the AH and transmitted along with packets. On the receiving side, the peer will perform the same one-way hash on the packet and compare the value with the one in the AH it receives.

Encapsulating Security Payload (ESP) is a security protocol that provides data confidentiality and protection with optional authentication and replay detection service.

VPN and Remote Access >> IPsec General Setup

VPN IKE/IPsec General Setup

Dial-in Set up for Remote Dial-in users and Dynamic IP Client (LAN to LAN).

IKE Authentication Method

Certificate for Dial-in None ▾

General Pre-Shared Key

Pre-Shared Key Max: 64 characters

Confirm Pre-Shared Key

Pre-Shared Key for XAuth User

Pre-Shared Key Max: 64 characters

Confirm Pre-Shared Key

IPsec Security Method

Medium (AH)
Data will be authenticated, but will not be encrypted.

High (ESP) DES 3DES AES
Data will be encrypted and authenticated.

Available settings are explained as follows:

Item	Description
IKE Authentication Method	This usually applies to those are remote dial-in user or node (LAN-to-LAN) which uses dynamic IP address and IPsec-related VPN connections such as L2TP over IPsec and

	<p>IPsec tunnel. There are two methods offered by Vigor router for you to authenticate the incoming data coming from remote dial-in user, Certificate (X.509) and Pre-Shared Key.</p> <p>Certificate for Dial-in -Choose one of the local certificates from the drop down list.</p> <p>General Pre-Shared Key - Define the PSK key for general authentication.</p> <ul style="list-style-type: none"> ● Pre-Shared Key- Specify a key for IKE authentication. ● Confirm Pre-Shared Key- Retype the characters to confirm the pre-shared key. <p>Pre-Shared Key for XAuth User - Define the PSK key for IPsec XAuth authentication.</p> <ul style="list-style-type: none"> ● Pre-Shared Key- Specify a key for IKE authentication. ● Confirm Pre-Shared Key- Retype the characters to confirm the pre-shared key. <p>Note: Any packets from the remote dial-in user which does not match the rule defined in VPN and Remote Access>>Remote Dial-In User will be applied with the method specified here.</p>
<p>IPsec Security Method</p>	<p>Medium - Authentication Header (AH) means data will be authenticated, but not be encrypted. By default, this option is active.</p> <p>High (ESP) - Encapsulating Security Payload (ESP) means payload (data) will be encrypted and authenticated. You may select encryption algorithm from Data Encryption Standard (DES), Triple DES (3DES), and AES.</p>

After finishing all the settings here, please click OK to save the configuration.

IV-1-6 IPsec Peer Identity

To use digital certificate for peer authentication in either LAN-to-LAN connection or Remote User Dial-In connection, here you may edit a table of peer certificate for selection. As shown below, the router provides 32 entries of digital certificates for peer dial-in users.

VPN and Remote Access >> IPsec Peer Identity

X509 Peer ID Accounts: [Set to Factory Default](#)

Index	Name	Status	Index	Name	Status
1.	???	X	17.	???	X
2.	???	X	18.	???	X
3.	???	X	19.	???	X
4.	???	X	20.	???	X
5.	???	X	21.	???	X
6.	???	X	22.	???	X
7.	???	X	23.	???	X
8.	???	X	24.	???	X
9.	???	X	25.	???	X
10.	???	X	26.	???	X
11.	???	X	27.	???	X
12.	???	X	28.	???	X
13.	???	X	29.	???	X
14.	???	X	30.	???	X
15.	???	X	31.	???	X
16.	???	X	32.	???	X

Available settings are explained as follows:

Item	Description
Set to Factory Default	Click it to clear all indexes.
Index	Click the number below Index to access into the setting page of IPsec Peer Identity.
Name	Display the profile name of that index.

Click each index to edit one peer digital certificate. There are three security levels of digital signature authentication: Fill each necessary field to authenticate the remote peer. The following explanation will guide you to fill all the necessary fields.

Profile Index : 1

Profile Name	<input data-bbox="507 304 699 338" type="text" value="???"/>
<input type="checkbox"/> Enable this account	
<input checked="" type="radio"/> Accept Any Peer ID	
<input type="radio"/> Accept Subject Alternative Name	
Type	<input data-bbox="762 499 919 528" type="text" value="Domain Name"/>
Domain Name	<input data-bbox="762 533 1168 566" type="text"/>
<input type="radio"/> Accept Subject Name	
Country (C)	<input data-bbox="762 633 836 667" type="text"/>
State (ST)	<input data-bbox="762 672 1168 705" type="text"/>
Location (L)	<input data-bbox="762 710 1168 743" type="text"/>
Organization (O)	<input data-bbox="762 748 1168 781" type="text"/>
Organization Unit (OU)	<input data-bbox="762 786 1168 819" type="text"/>
Common Name (CN)	<input data-bbox="762 824 1168 857" type="text"/>
Email (E)	<input data-bbox="762 862 1168 896" type="text"/>

Available settings are explained as follows:

Item	Description
Profile Name	Enter the name of the profile. The maximum length of the name you can set is 32 characters.
Enable this account	Check it to enable such account profile.
Accept Any Peer ID	Click to accept any peer regardless of its identity.
Accept Subject Alternative Name	Click to check one specific field of digital signature to accept the peer with matching value. The field can be IP Address , Domain , or E-mail . The box under the Type will appear according to the type you select and ask you to fill in corresponding setting.
Accept Subject Name	Click to check the specific fields of digital signature to accept the peer with matching value. The field includes Country (C) , State (ST) , Location (L) , Organization (O) , Organization Unit (OU) , Common Name (CN) , and Email (E) .

After finishing all the settings here, please click OK to save the configuration.

IV-1-7 Remote Dial-in User

You can manage remote access by maintaining a table of remote user profile, so that users can be authenticated to dial-in via VPN connection. You may set parameters including specified connection peer ID, connection type (VPN connection - including PPTP, IPsec Tunnel, and L2TP by itself or over IPsec) and corresponding security methods, etc.

The router provides multiple access accounts for dial-in users. Besides, you can extend the user accounts to the RADIUS server through the built-in RADIUS client function. The following figure shows the summary table.

VPN and Remote Access >> Remote Dial-in User



Remote Access User Accounts: | [Set to Factory Default](#) |

Index	Enable	User	Status	Index	Enable	User	Status
1.	<input type="checkbox"/>	???	---	17.	<input type="checkbox"/>	???	---
2.	<input type="checkbox"/>	???	---	18.	<input type="checkbox"/>	???	---
3.	<input type="checkbox"/>	???	---	19.	<input type="checkbox"/>	???	---
4.	<input type="checkbox"/>	???	---	20.	<input type="checkbox"/>	???	---
5.	<input type="checkbox"/>	???	---	21.	<input type="checkbox"/>	???	---
6.	<input type="checkbox"/>	???	---	22.	<input type="checkbox"/>	???	---
7.	<input type="checkbox"/>	???	---	23.	<input type="checkbox"/>	???	---
8.	<input type="checkbox"/>	???	---	24.	<input type="checkbox"/>	???	---
9.	<input type="checkbox"/>	???	---	25.	<input type="checkbox"/>	???	---
10.	<input type="checkbox"/>	???	---	26.	<input type="checkbox"/>	???	---
11.	<input type="checkbox"/>	???	---	27.	<input type="checkbox"/>	???	---
12.	<input type="checkbox"/>	???	---	28.	<input type="checkbox"/>	???	---
13.	<input type="checkbox"/>	???	---	29.	<input type="checkbox"/>	???	---
14.	<input type="checkbox"/>	???	---	30.	<input type="checkbox"/>	???	---
15.	<input type="checkbox"/>	???	---	31.	<input type="checkbox"/>	???	---
16.	<input type="checkbox"/>	???	---	32.	<input type="checkbox"/>	???	---

Backup setting to file: <input type="button" value="Backup"/>	Restore From File: <input type="button" value="選擇檔案"/> 未選擇任何檔案 <input type="button" value="Restore"/>
--	--

Download Smart VPN Client:

[Smart VPN Client for Windows PC](#)

[Smart VPN Android/iOS App](#)

Available settings are explained as follows:

Item	Description
Set to Factory Default	Click to clear all indexes.
Index	Click the number below Index to access into the setting page of Remote Dial-in User.
Enable	Check the box to enable the profile.
User	Display the username for the specific dial-in user of the LAN-to-LAN profile. The symbol ??? represents that the

	profile is empty.
Status	Display the access state of the specific dial-in user. The symbol V and X represent the specific dial-in user to be active and inactive, respectively.

Click each index to edit one remote user profile. Each Dial-In Type requires you to fill the different corresponding fields on the right. If the fields gray out, it means you may leave it untouched. The following explanation will guide you to fill all the necessary fields.

VPN and Remote Access >> Remote Dial-in User

Index No. 1

<p>User account and Authentication</p> <p><input type="checkbox"/> Enable this account</p> <p>Idle Timeout <input type="text" value="300"/> second(s)</p> <hr/> <p>Allowed Dial-In Type</p> <p><input checked="" type="checkbox"/> PPTP</p> <p><input checked="" type="checkbox"/> IPsec Tunnel</p> <p><input checked="" type="checkbox"/> L2TP with IPsec Policy <input type="text" value="None"/></p> <p><input checked="" type="checkbox"/> SSL Tunnel</p> <p><input checked="" type="checkbox"/> IPsec XAuth</p> <p><input type="checkbox"/> Specify Remote Node</p> <p>Remote Client IP <input type="text"/></p> <p>or Peer ID <input type="text"/></p> <p>Netbios Naming Packet <input checked="" type="radio"/> Pass <input type="radio"/> Block</p> <p>Multicast via VPN <input type="radio"/> Pass <input checked="" type="radio"/> Block (for some IGMP,IP-Camera,DHCP Relay..etc.)</p> <hr/> <p>Subnet</p> <p><input type="text" value="LAN 1"/></p> <p><input type="checkbox"/> Assign Static IP Address</p> <p><input type="text" value="0.0.0.0"/></p>	<p>Username <input type="text" value="???"/> Max: 19 characters</p> <p>Password <input type="text" value="Max: 19 characters"/></p> <p><input type="checkbox"/> Enable Mobile One-Time Passwords(mOTP)</p> <p>PIN <input type="text"/></p> <p>Code <input type="text"/></p> <p>Secret <input type="text"/></p> <hr/> <p>IKE Authentication Method</p> <p><input checked="" type="checkbox"/> Pre-Shared Key</p> <p><input type="text" value="IKE Pre-Shared Key"/> Max: 64 characters</p> <p><input type="checkbox"/> Digital Signature(X.509)</p> <p><input type="text" value="None"/></p> <hr/> <p>IPsec Security Method</p> <p><input checked="" type="checkbox"/> Medium(AH)</p> <p>High(ESP) <input checked="" type="checkbox"/> DES <input checked="" type="checkbox"/> 3DES <input checked="" type="checkbox"/> AES</p> <p>Local ID (optional) <input type="text"/></p>
---	--

Note:
Username can not contain characters " and '.

Available settings are explained as follows:

Item	Description
User account and Authentication	<p>Enable this account - Check the box to enable this function.</p> <p>Idle Timeout- If the dial-in user is idle over the limitation of the timer, the router will drop this connection. By default, the Idle Timeout is set to 300 seconds.</p>
Allowed Dial-In Type	<p>PPTP - Allow the remote dial-in user to make a PPTP VPN connection through the Internet. You should set the User Name and Password of remote dial-in user below.</p> <p>IPsec Tunnel - Allow the remote dial-in user to make an IPsec VPN connection through Internet.</p> <p>L2TP with IPsec Policy - Allow the remote dial-in user to make a L2TP VPN connection through the Internet. You can select to use L2TP alone or with IPsec. Select from below:</p>

	<ul style="list-style-type: none"> ● None - Do not apply the IPsec policy. Accordingly, the VPN connection employed the L2TP without IPsec policy can be viewed as one pure L2TP connection. ● Nice to Have - Apply the IPsec policy first, if it is applicable during negotiation. Otherwise, the dial-in VPN connection becomes one pure L2TP connection. ● Must -Specify the IPsec policy to be definitely applied on the L2TP connection. <p>SSL Tunnel - Allow the remote dial-in user to make an SSL VPN connection through Internet.</p> <p>IPsec XAuth - Allow the remote dial-in user to make an IPsec VPN connection through XAuth server in Internet.</p> <p>Specify Remote Node -You can specify the IP address of the remote dial-in user, ISDN number or peer ID (used in IKE aggressive mode).</p> <p>Uncheck the checkbox means the connection type you select above will apply the authentication methods and security methods in the general settings.</p> <p>Netbios Naming Packet -</p> <ul style="list-style-type: none"> ● Pass - Click it to have an inquiry for data transmission between the hosts located on both sides of VPN Tunnel while connecting. ● Block - When there is conflict occurred between the hosts on both sides of VPN Tunnel in connecting, such function can block data transmission of Netbios Naming Packet inside the tunnel. <p>Multicast via VPN - Some programs might send multicast packets via VPN connection.</p> <ul style="list-style-type: none"> ● Pass - Click this button to let multicast packets pass through the router. ● Block - This is default setting. Click this button to let multicast packets be blocked by the router. <p>User Name - This field is applicable when you select PPTP or L2TP with or without IPsec policy above. The length of the name is limited to 23 characters.</p> <p>Password - This field is applicable when you select PPTP or L2TP with or without IPsec policy above. The length of the password is limited to 19 characters.</p> <p>Enable Mobile One-Time Passwords (mOTP) - Check this box to make the authentication with mOTP function.</p> <p>PIN Code - Enter the code for authentication (e.g, 1234).</p> <p>Secret - Use the 32 digit-secret number generated by mOTP in the mobile phone (e.g., e759bb6f0e94c7ab4fe6).</p>
Subnet	<p>Chose one of the subnet selections for such VPN profile.</p> <p>Assign Static IP Address - Please type a static IP address for the subnet you specified.</p>
IKE Authentication Method	<p>This group of fields is applicable for IPsec Tunnels and L2TP with IPsec Policy when you specify the IP address of the remote node. The only exception is Digital Signature (X.509) can be set when you select IPsec tunnel either with or without specifying the IP address of the remote node.</p> <p>Pre-Shared Key - Check the box of Pre-Shared Key to invoke this function and Enter the required characters (1-63) as the</p>

	pre-shared key. Digital Signature (X.509) - Check the box of Digital Signature to invoke this function and Select one predefined Profiles set in the VPN and Remote Access >>IPsec Peer Identity.
IPsec Security Method	This group of fields is a must for IPsec Tunnels and L2TP with IPsec Policy when you specify the remote node. Check the Medium, DES, 3DES or AES box as the security method. Medium-Authentication Header (AH) means data will be authenticated, but not be encrypted. By default, this option is invoked. You can uncheck it to disable it. High-Encapsulating Security Payload (ESP) means payload (data) will be encrypted and authenticated. You may select encryption algorithm from Data Encryption Standard (DES), Triple DES (3DES), and AES. Local ID (Optional) - Specify a local ID to be used for Dial-in setting in the LAN-to-LAN Profile setup. This item is optional and can be used only in IKE aggressive mode.

After finishing all the settings here, please click OK to save the configuration.

IV-1-8 LAN to LAN

Here you can manage LAN-to-LAN connections by maintaining a table of connection profiles. You may set parameters including specified connection direction (dial-in or dial-out), connection peer ID, connection type (VPN connection - including PPTP, IPsec Tunnel, and L2TP by itself or over IPsec) and corresponding security methods, etc.

VPN and Remote Access >> LAN to LAN



LAN-to-LAN Profiles:

[Set to Factory Default](#)

Index	Enable	Name	Remote Network	Status	Index	Enable	Name	Remote Network	Status
<u>1.</u>	<input type="checkbox"/>	???		---	<u>17.</u>	<input type="checkbox"/>	???		---
<u>2.</u>	<input type="checkbox"/>	???		---	<u>18.</u>	<input type="checkbox"/>	???		---
<u>3.</u>	<input type="checkbox"/>	???		---	<u>19.</u>	<input type="checkbox"/>	???		---
<u>4.</u>	<input type="checkbox"/>	???		---	<u>20.</u>	<input type="checkbox"/>	???		---
<u>5.</u>	<input type="checkbox"/>	???		---	<u>21.</u>	<input type="checkbox"/>	???		---
<u>6.</u>	<input type="checkbox"/>	???		---	<u>22.</u>	<input type="checkbox"/>	???		---
<u>7.</u>	<input type="checkbox"/>	???		---	<u>23.</u>	<input type="checkbox"/>	???		---
<u>8.</u>	<input type="checkbox"/>	???		---	<u>24.</u>	<input type="checkbox"/>	???		---
<u>9.</u>	<input type="checkbox"/>	???		---	<u>25.</u>	<input type="checkbox"/>	???		---
<u>10.</u>	<input type="checkbox"/>	???		---	<u>26.</u>	<input type="checkbox"/>	???		---
<u>11.</u>	<input type="checkbox"/>	???		---	<u>27.</u>	<input type="checkbox"/>	???		---
<u>12.</u>	<input type="checkbox"/>	???		---	<u>28.</u>	<input type="checkbox"/>	???		---
<u>13.</u>	<input type="checkbox"/>	???		---	<u>29.</u>	<input type="checkbox"/>	???		---
<u>14.</u>	<input type="checkbox"/>	???		---	<u>30.</u>	<input type="checkbox"/>	???		---
<u>15.</u>	<input type="checkbox"/>	???		---	<u>31.</u>	<input type="checkbox"/>	???		---
<u>16.</u>	<input type="checkbox"/>	???		---	<u>32.</u>	<input type="checkbox"/>	???		---

OK

Cancel

Backup setting to file:

Backup

Upload From File:

選擇檔案 未選擇任何檔案

Restore

Available settings are explained as follows:

Item	Description
Set to Factory Default	Click to clear all indexes.
Index	Click the number link to access into the setting page of a VPN profile.
Enable	Check it to enable such LAN to LAN profile.
Name	Indicate the name of the LAN-to-LAN profile. The symbol ??? represents that the profile is empty.
Remote Network	Display the IP address with the netmask of remote network.
Status	Online - means such LAN to LAN profile is in use. Offline - means such LAN to LAN profile isn't in use even if the profile has been enabled.

To edit each profile:

1. Click each index to edit each profile and you will get the following page. Each LAN-to-LAN profile includes 4 subgroups. If the fields gray out, it means you may leave it untouched. The following explanations will guide you to fill all the necessary fields.

VPN and Remote Access >> LAN to LAN

Profile Index : 1

1. Common Settings

Profile Name <input type="text" value="???"/> <input type="checkbox"/> Enable this profile VPN Dial-Out Through <input type="text" value="WAN1 First"/> Netbios Naming Packet <input checked="" type="radio"/> Pass <input type="radio"/> Block Multicast via VPN <input type="radio"/> Pass <input checked="" type="radio"/> Block <small>(for some IGMP,IP-Camera,DHCP Relay..etc.)</small>	Call Direction <input checked="" type="radio"/> Both <input type="radio"/> Dial-Out <input type="radio"/> Dial-in <input type="checkbox"/> Always on Idle Timeout <input type="text" value="300"/> second(s) <input type="checkbox"/> Enable PING to keep IPsec tunnel alive PING to the IP <input type="text" value=""/>
---	---

2. Dial-Out Settings

Type of Server I am calling <input checked="" type="radio"/> PPTP <input type="radio"/> IPsec Tunnel <input type="text" value="IKEv1"/> <input type="radio"/> L2TP with IPsec Policy <input type="text" value="None"/> <input type="radio"/> SSL Tunnel Server IP/Host Name for VPN. <small>(such as draytek.com or 123.45.67.89)</small> <input type="text" value=""/> <small>Max: 41 characters</small> Server Port (for SSL Tunnel): <input type="text" value="443"/>	Username <input type="text" value="???"/> Password <input type="text" value=""/> <small>Max: 15 characters</small> PPP Authentication <input type="text" value="PAP/CHAP/MS-CHAP/MS-CHAPv2"/> VJ Compression <input checked="" type="radio"/> On <input type="radio"/> Off IKE Authentication Method <input checked="" type="radio"/> Pre-Shared Key <input type="text" value=""/> <small>Max: 64 characters</small> <input type="radio"/> Digital Signature(X.509) Peer ID <input type="text" value="None"/> Local ID <input checked="" type="radio"/> Alternative Subject Name First <input type="radio"/> Subject Name First Local Certificate <input type="text" value="None"/> IPsec Security Method <input type="radio"/> Medium(AH) <input checked="" type="radio"/> High(ESP) <input type="text" value="AES with Authentication"/> <input type="button" value="Advanced"/> Schedule Profile <input type="text" value="None"/> , <input type="text" value="None"/> , <input type="text" value="None"/> , <input type="text" value="None"/>
--	--

Available settings are explained as follows:

Item	Description
Common Settings	Profile Name - Specify a name for the profile of the LAN-to-LAN connection. Enable this profile - Check here to activate this profile.

VPN Dial-Out Through - Use the drop down menu to choose a proper WAN interface for this profile. This setting is useful for dial-out only.

- **WAN1 First/ WAN2 First/ LTE First** - While connecting, the router will use WAN1/WAN2/WAN3 or LTE/WAN4 as the first channel for VPN connection. If WAN1/WAN2/WAN3 or LTE/WAN4 fails, the router will use another WAN interface instead.
- **WAN1 Only /WAN2 Only/ LTE Only** - While connecting, the router will use WAN1/WAN2/WAN3 or LTE/WAN4 as the only channel for VPN connection.
- **WAN1 Only: Only establish VPN if WAN2 down** - If WAN2 failed, the router will use WAN1 for VPN connection.
- **WAN2 Only: Only establish VPN if WAN1 down** - If WAN1 failed, the router will use WAN2 for VPN connection.

Netbios Naming Packet

- **Pass** - click it to have an inquiry for data transmission between the hosts located on both sides of VPN Tunnel while connecting.
- **Block** - When there is conflict occurred between the hosts on both sides of VPN Tunnel in connecting, such function can block data transmission of Netbios Naming Packet inside the tunnel.

Multicast via VPN - Some programs might send multicast packets via VPN connection.

- **Pass** - Click this button to let multicast packets pass through the router.
- **Block** - This is default setting. Click this button to let multicast packets be blocked by the router.

Call Direction - Specify the allowed call direction of this LAN-to-LAN profile.

- **Both**:-initiator/responder
- **Dial-Out**- initiator only
- **Dial-In**- responder only.

Always On-Check to enable router always keep VPN connection.

Idle Timeout: The default value is 300 seconds. If the connection has been idled over the value, the router will drop the connection.

Enable PING to keep IPsec tunnel alive - This function is to help the router to determine the status of IPsec VPN connection, especially useful in the case of abnormal VPN IPsec tunnel disruption. For details, please refer to the note below. Check to enable the transmission of PING packets to a specified IP address.

This function is used to handle abnormal IPsec VPN connection disruption. It will help to provide the state of a VPN connection for router's judgment of redial. Normally, if any one of VPN peers wants to disconnect the connection, it should follow a serial of packet exchange procedure to inform each other. However, if the remote peer disconnects without notice, Vigor router will by no where to know this situation. To resolve this dilemma, by continuously sending PING packets to the remote host, the Vigor router can know

	<p>the true existence of this VPN connection and react accordingly. This is independent of DPD (dead peer detection).</p> <p>PING to the IP - Enter the IP address of the remote host that located at the other-end of the VPN tunnel.</p>
Dial-Out Settings	<p>Type of Server I am calling - PPTP - Build a PPTP VPN connection to the server through the Internet. You should set the identity like User Name and Password below for the authentication of remote server.</p> <p>IPsec Tunnel - Build an IPsec VPN connection to the server through Internet.</p> <p>L2TP with IPsec Policy - Build a L2TP VPN connection through the Internet. You can select to use L2TP alone or with IPsec. Select from below:</p> <ul style="list-style-type: none"> ● None: Do not apply the IPsec policy. Accordingly, the VPN connection employed the L2TP without IPsec policy can be viewed as one pure L2TP connection. ● Nice to Have: Apply the IPsec policy first, if it is applicable during negotiation. Otherwise, the dial-out VPN connection becomes one pure L2TP connection. ● Must: Specify the IPsec policy to be definitely applied on the L2TP connection. <p>SSL Tunnel - Build an SSL VPN connection to the server through Internet.</p> <p>User Name - This field is applicable when you select, PPTP or L2TP with or without IPsec policy above. The length of the name is limited to 49 characters.</p> <p>Password - This field is applicable when you select PPTP or L2TP with or without IPsec policy above. The length of the password is limited to 15 characters.</p> <p>PPP Authentication - This field is applicable when you select, PPTP or L2TP with or without IPsec policy above. PAP/CHAP/MS-CHAP/MS-CHAPv2 is the most common selection due to compatibility.</p> <p>VJ compression - This field is applicable when you select PPTP or L2TP with or without IPsec policy above. VJ Compression is used for TCP/IP protocol header compression. Normally set to On to improve bandwidth utilization.</p> <p>IKE Authentication Method - This group of fields is applicable for IPsec Tunnels and L2TP with IPsec Policy.</p> <ul style="list-style-type: none"> ● Pre-Shared Key - Input 1-63 characters as pre-shared key. ● Digital Signature (X.509) - Select one predefined Profiles set in the VPN and Remote Access >>IPsec Peer Identity. Peer ID - Select one of the predefined Profiles set in VPN and Remote Access >>IPsec Peer Identity. Local ID - Specify a local ID (Alternative Subject Name First or Subject Name First) to be used for Dial-in setting in the LAN-to-LAN Profile setup. This item is optional and can be used only in IKE aggressive mode. ● Local Certificate - Select one of the profiles set in Certificate Management>>Local Certificate. <p>IPsec Security Method - This group of fields is a must for IPsec Tunnels and L2TP with IPsec Policy.</p>

- **Medium AH (Authentication Header)** means data will be authenticated, but not be encrypted. By default, this option is active.
- **High (ESP-Encapsulating Security Payload)**- means payload (data) will be encrypted and authenticated. Select from below:
 - **DES without Authentication** -Use DES encryption algorithm and not apply any authentication scheme.
 - **DES with Authentication**-Use DES encryption algorithm and apply MD5 or SHA-1 authentication algorithm.
 - **3DES without Authentication**-Use triple DES encryption algorithm and not apply any authentication scheme.
 - **3DES with Authentication**-Use triple DES encryption algorithm and apply MD5 or SHA-1 authentication algorithm.
 - **AES without Authentication**-Use AES encryption algorithm and not apply any authentication scheme.
 - **AES with Authentication**-Use AES encryption algorithm and apply MD5 or SHA-1 authentication algorithm.

Advanced - Specify mode, proposal and key life of each IKE phase, Gateway, etc.

The window of advance setup is shown as below:

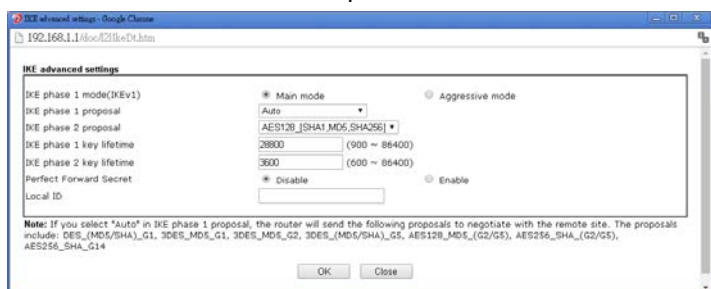

IKE phase 1 mode -Select from **Main mode** and **Aggressive mode**. The ultimate outcome is to exchange security proposals to create a protected secure channel. **Main mode** is more secure than **Aggressive mode** since more exchanges are done in a secure channel to set up the IPsec session. However, the **Aggressive mode** is faster. The default value in Vigor router is **Main mode**.

- **IKE phase 1 proposal**-To propose the local available authentication schemes and encryption algorithms to the VPN peers, and get its feedback to find a match. Two combinations are available for **Aggressive mode** and nine for **Main mode**. We suggest you select the combination that covers the most schemes.
- **IKE phase 2 proposal**-To propose the local available algorithms to the VPN peers, and get its feedback to find a match. Three combinations are available for both modes. We suggest you select the combination that covers the most algorithms.
- **IKE phase 1 key lifetime**-For security reason, the lifetime of key should be defined. The default value is 28800 seconds. You may specify a value in between 900

and 86400 seconds.

- **IKE phase 2 key lifetime**-For security reason, the lifetime of key should be defined. The default value is 3600 seconds. You may specify a value in between 600 and 86400 seconds.
- **Perfect Forward Secret (PFS)**-The IKE Phase 1 key will be reused to avoid the computation complexity in phase 2. The default value is inactive this function.
Local ID-In Aggressive mode, Local ID is on behalf of the IP address while identity authenticating with remote VPN server. The length of the ID is limited to 47 characters.

Schedule Profile - Set the wireless LAN to work at certain time interval only. You may choose up to 4 schedules out of the 15 schedules pre-defined in **Applications >> Schedule** setup. The default setting of this field is blank and the function will always work.

3. Dial-In Settings

<p>Allowed Dial-In Type</p> <p><input checked="" type="checkbox"/> PPTP</p> <p><input checked="" type="checkbox"/> IPsec Tunnel</p> <p><input checked="" type="checkbox"/> L2TP with IPsec Policy None</p> <p><input checked="" type="checkbox"/> SSL Tunnel</p> <p><input type="checkbox"/> Specify Remote VPN Gateway</p> <p>Peer VPN Server IP <input style="width: 100%;" type="text"/></p> <p>or Peer ID <input style="width: 100%;" type="text"/></p>	<p>Username <input data-bbox="1141 831 1345 860" style="width: 100%;" type="text" value="???"/></p> <p>Password(Max 11 char) <input data-bbox="1141 864 1345 893" style="width: 100%;" type="password"/></p> <p>VJ Compression <input checked="" type="radio"/> On <input type="radio"/> Off</p> <hr/> <p>IKE Authentication Method</p> <p><input checked="" type="checkbox"/> Pre-Shared Key</p> <p>IKE Pre-Shared Key <input data-bbox="1141 1010 1345 1039" style="width: 100%;" type="text"/></p> <p><input type="checkbox"/> Digital Signature(X.509)</p> <p>None</p> <p>Local ID</p> <p><input checked="" type="radio"/> Alternative Subject Name First</p> <p><input type="radio"/> Subject Name First</p> <hr/> <p>IPsec Security Method</p> <p><input checked="" type="checkbox"/> Medium(AH)</p> <p>High(ESP) <input checked="" type="checkbox"/> DES <input checked="" type="checkbox"/> 3DES <input checked="" type="checkbox"/> AES</p>
--	--

4. TCP/IP Network Settings

<p>My WAN IP <input data-bbox="635 1350 839 1379" style="width: 100%;" type="text" value="0.0.0.0"/></p> <p>Remote Gateway IP <input data-bbox="635 1384 839 1413" style="width: 100%;" type="text" value="0.0.0.0"/></p> <p>Remote Network IP <input data-bbox="635 1417 839 1447" style="width: 100%;" type="text" value="0.0.0.0"/></p> <p>Remote Network Mask <input data-bbox="635 1451 839 1480" style="width: 100%;" type="text" value="255.255.255.0"/></p> <p>Local Network IP <input data-bbox="635 1485 839 1514" style="width: 100%;" type="text" value="192.168.1.1"/></p> <p>Local Network Mask <input data-bbox="635 1518 839 1547" style="width: 100%;" type="text" value="255.255.255.0"/></p> <p style="text-align: right;"><input data-bbox="639 1563 703 1592" type="button" value="More"/></p>	<p>RIP Direction Disable</p> <p>From first subnet to remote network, you have to do Route</p> <p><input type="checkbox"/> IPsec VPN with the Same Subnets</p> <p><input type="checkbox"/> Change default route to this VPN tunnel (Only active if one single WAN is up)</p>
---	--

Available settings are explained as follows:

Item	Description
Dial-In Settings	<p>Allowed Dial-In Type - Determine the dial-in connection with different types.</p> <ul style="list-style-type: none"> ● PPTP - Allow the remote dial-in user to make a PPTP VPN connection through the Internet. You should set the User Name and Password of remote dial-in user below. ● IPsec Tunnel- Allow the remote dial-in user to trigger

an IPsec VPN connection through Internet.

- **L2TP with IPsec Policy** - Allow the remote dial-in user to make a L2TP VPN connection through the Internet. You can select to use L2TP alone or with IPsec. Select from below:
 - **None** - Do not apply the IPsec policy. Accordingly, the VPN connection employed the L2TP without IPsec policy can be viewed as one pure L2TP connection.
 - **Nice to Have** - Apply the IPsec policy first, if it is applicable during negotiation. Otherwise, the dial-in VPN connection becomes one pure L2TP connection.
 - **Must** - Specify the IPsec policy to be definitely applied on the L2TP connection.
- **SSL Tunnel**- Allow the remote dial-in user to trigger an SSL VPN connection through Internet.

Specify Remote VPN Gateway - You can specify the IP address of the remote dial-in user or peer ID (should be the same with the ID setting in dial-in type) by checking the box. Also, you should further specify the corresponding security methods on the right side.

If you uncheck the checkbox, the connection type you select above will apply the authentication methods and security methods in the general settings.

Username - This field is applicable when you select PPTP or L2TP with or without IPsec policy above. The length of the name is limited to 11 characters.

Password - This field is applicable when you select PPTP or L2TP with or without IPsec policy above. The length of the password is limited to 11 characters.

VJ Compression - VJ Compression is used for TCP/IP protocol header compression. This field is applicable when you select PPTP or L2TP with or without IPsec policy above.

IKE Authentication Method - This group of fields is applicable for IPsec Tunnels and L2TP with IPsec Policy when you specify the IP address of the remote node. The only exception is Digital Signature (X.509) can be set when you select IPsec tunnel either with or without specify the IP address of the remote node.

- **Pre-Shared Key** - Check the box of Pre-Shared Key to invoke this function and Enter the required characters (1-63) as the pre-shared key.
 - **Digital Signature (X.509)** -Check the box of Digital Signature to invoke this function and select one predefined Profiles set in the **VPN and Remote Access >>IPsec Peer Identity**.
 - **Local ID** - Specify which one will be inspected first.
 - **Alternative Subject Name First** - The alternative subject name (configured in **Certificate Management>>Local Certificate**) will be inspected first.
 - **Subject Name First** - The subject name (configured in **Certificate Management>>Local Certificate**) will be inspected first.
-

IPsec Security Method - This group of fields is a must for IPsec Tunnels and L2TP with IPsec Policy when you specify the remote node.

- **Medium-** Authentication Header (AH) means data will be authenticated, but not be encrypted. By default, this option is active.
- **High-** Encapsulating Security Payload (ESP) means payload (data) will be encrypted and authenticated. You may select encryption algorithm from Data Encryption Standard (DES), Triple DES (3DES), and AES.

TCP/IP Network Settings

My WAN IP -This field is only applicable when you select PPTP or L2TP with or without IPsec policy above. The default value is 0.0.0.0, which means the Vigor router will get a PPP IP address from the remote router during the IPCP negotiation phase. If the PPP IP address is fixed by remote side, specify the fixed IP address here. Do not change the default value if you do not select PPTP or L2TP.

Remote Gateway IP - This field is only applicable when you select PPTP or L2TP with or without IPsec policy above. The default value is 0.0.0.0, which means the Vigor router will get a remote Gateway PPP IP address from the remote router during the IPCP negotiation phase. If the PPP IP address is fixed by remote side, specify the fixed IP address here. Do not change the default value if you do not select PPTP or L2TP.

Remote Network IP/ Remote Network Mask - Add a static route to direct all traffic destined to this Remote Network IP Address/Remote Network Mask through the VPN connection. For IPsec, this is the destination clients IDs of phase 2 quick mode.

Local Network IP / Local Network Mask - Display the local network IP and mask for TCP / IP configuration. You can modify the settings if required.

More - Add a static route to direct all traffic destined to more Remote Network IP Addresses/ Remote Network Masks through the VPN connection. This is usually used when you find there are several subnets behind the remote VPN router.

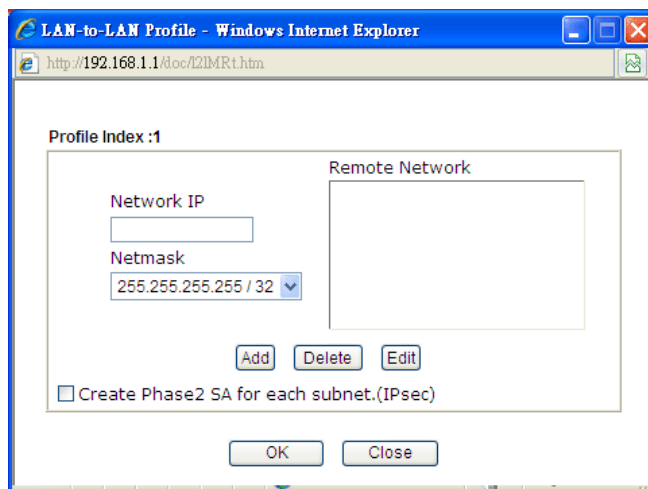

RIP Direction - The option specifies the direction of RIP (Routing Information Protocol) packets. You can enable/disable one of direction here. Herein, we provide four options: TX/RX Both, TX Only, RX Only, and Disable.

From first subnet to remote network, you have to do - If

	<p>the remote network only allows you to dial in with single IP, please choose NAT, otherwise choose Route.</p> <p>Change default route to this VPN tunnel - Check this box to change the default route with this VPN tunnel.</p>								
<p>IPSec VPN with the Same subnet</p>	<p>For both ends (e.g., different sections in a company) are within the same subnet, there is a function which allows you to build Virtual IP mapping between two ends. Thus, when VPN connection established, the router will change the IP address according to the settings configured here and block sessions which are not coming from the IP address defined in the Virtual IP Mapping list.</p> <p>After checking the box of IPSec VPN with the Same subnet, the options under TCP/IP Network Settings will be changed as shown below:</p> <div data-bbox="699 667 1401 842" style="border: 1px solid black; padding: 5px;"> <p>5. TCP/IP Network Settings</p> <table border="0"> <tr> <td style="width: 150px;">Remote Network IP</td> <td><input type="text" value="0.0.0.0"/></td> <td rowspan="2" style="vertical-align: top;">From Local Subnet to Remote network, you have to do</td> </tr> <tr> <td>Remote Network Mask</td> <td><input type="text" value="255.255.255.0"/></td> </tr> <tr> <td><input checked="" type="checkbox"/> Translated Local Network</td> <td> <input type="text" value="LAN1"/> to <input type="text" value="192.168.1.0"/> </td> <td> <input checked="" type="checkbox"/> IPSec VPN with the Same Subnets Translated Type <input checked="" type="radio"/> Whole Subnet <input type="radio"/> Specific IP Address </td> </tr> </table> <p style="text-align: right;"><input type="button" value="Route"/> <input type="button" value="Virtual IP Mapping"/></p> </div> <p>Remote Network IP/ Remote Network Mask - Add a static route to direct all traffic destined to this Remote Network IP Address/Remote Network Mask through the VPN connection. For IPSec, this is the destination clients IDs of phase 2 quick mode.</p> <p>Translated Local Network - This function is enabled in default. Use the drop down list to specify a LAN port as the transferred direction. Then specify an IP address. Click Advanced to configure detailed settings if required.</p> <p>Advanced - Add a static route to direct all traffic destined to more Remote Network IP Addresses/ Remote Network Mask through the VPN connection. This is usually used when you find there are several subnets behind the remote VPN router.</p>	Remote Network IP	<input type="text" value="0.0.0.0"/>	From Local Subnet to Remote network, you have to do	Remote Network Mask	<input type="text" value="255.255.255.0"/>	<input checked="" type="checkbox"/> Translated Local Network	<input type="text" value="LAN1"/> to <input type="text" value="192.168.1.0"/>	<input checked="" type="checkbox"/> IPSec VPN with the Same Subnets Translated Type <input checked="" type="radio"/> Whole Subnet <input type="radio"/> Specific IP Address
Remote Network IP	<input type="text" value="0.0.0.0"/>	From Local Subnet to Remote network, you have to do							
Remote Network Mask	<input type="text" value="255.255.255.0"/>								
<input checked="" type="checkbox"/> Translated Local Network	<input type="text" value="LAN1"/> to <input type="text" value="192.168.1.0"/>	<input checked="" type="checkbox"/> IPSec VPN with the Same Subnets Translated Type <input checked="" type="radio"/> Whole Subnet <input type="radio"/> Specific IP Address							

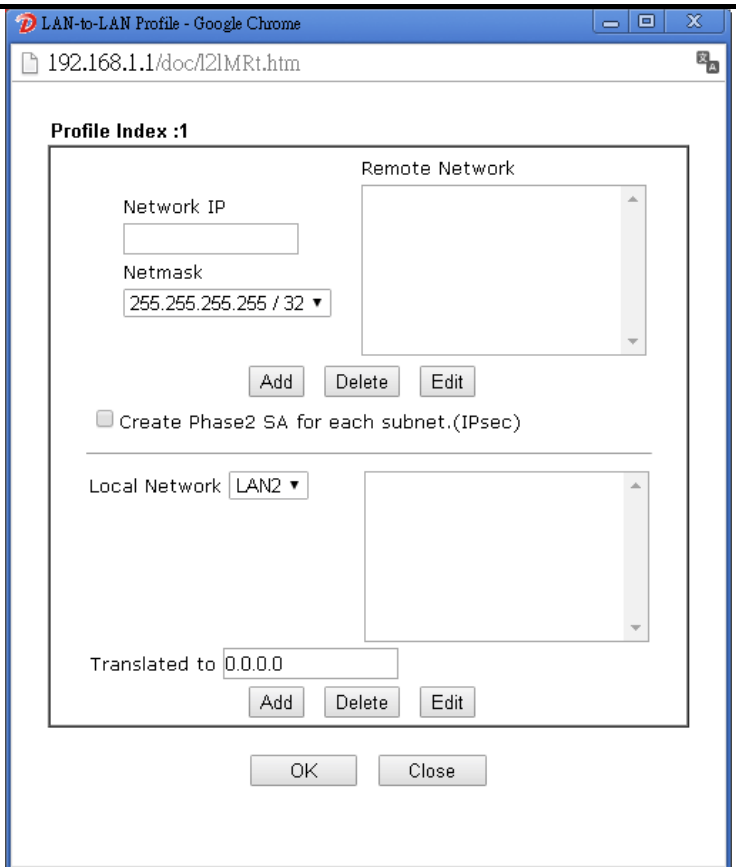

Translated Type - There are two types for you to choose.

- Whole Subnet
- Specific IP Address

Virtual IP Mapping - A pop up dialog will appear for you to specify the local IP address and the mapping virtual IP address.

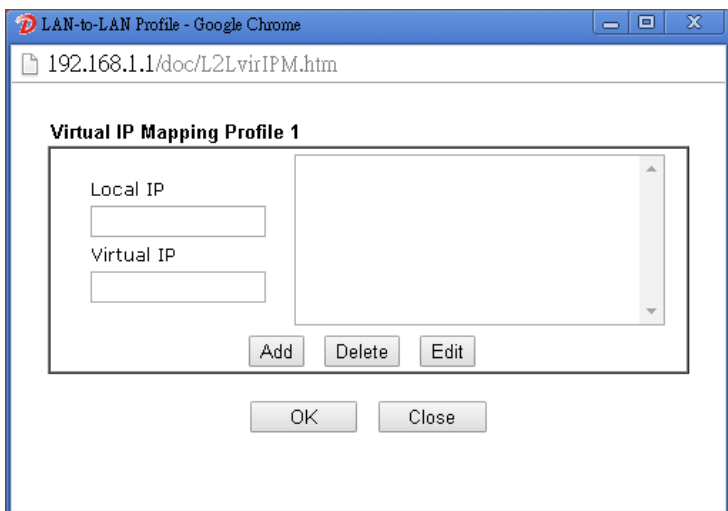

2. After finishing all the settings here, please click **OK** to save the configuration.

IV-1-9 Connection Management

You can find the summary table of all VPN connections. You may disconnect any VPN connection by clicking **Drop** button. You may also aggressively Dial-out by using Dial-out Tool and clicking **Dial** button.

VPN and Remote Access >> Connection Management

Dial-out Tool | [Refresh](#) |

Dial

VPN Connection Status

All VPN Status		LAN-to-LAN VPN Status		Remote Dial-in User Status				
VPN	Type	Remote IP	Virtual Network	Tx Pkts	Tx Rate(bps)	Rx Pkts	Rx Rate(bps)	UpTime

xxxxxxx : Data is encrypted.
xxxxxxx : Data isn't encrypted.

Available settings are explained as follows:

Item	Description
Dial-out Tool	<p>This field displays the profile configured in LAN-to-LAN (with Index number and VPN Server IP address). The VPN connection built by General Mode does not support VPN backup function.</p> <p>Dial - Click this button to execute dial out function.</p>

IV-2 SSL VPN

An SSL VPN (Secure Sockets Layer virtual private network) is a form of VPN that can be used with a standard Web browser.

There are two benefits that SSL VPN provides:

- It is not necessary for users to preinstall VPN client software for executing SSL VPN connection.
- There are less restrictions for the data encrypted through SSL VPN in comparing with traditional VPN.

Web User Interface

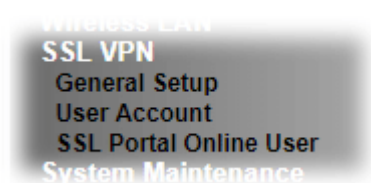

IV-2-1 General Setup

This page determines the general configuration for SSL VPN Server and SSL Tunnel.

SSL VPN >> General Setup

SSL VPN General Setup

Bind to WAN	<input checked="" type="checkbox"/> WAN1	<input checked="" type="checkbox"/> WAN2	<input checked="" type="checkbox"/> LTE
Port	<input type="text" value="443"/>	(Default: 443)	
Server Certificate	<input type="text" value="self-signed"/>		

Note:

1. The settings will act on all SSL applications.
2. Please go to [System Maintenance >> Management](#) to enable SSLv3.0 .
3. Please go to [System Maintenance >> Self-Signed Certificate](#) to generate a new "self-signed" certificate.

Available settings are explained as follows:

Item	Description
Bind to WAN	Choose and check WAN interface(s) for SSL VPN tunnel establishment.
Port	Such port is set for SSL VPN server. It will not affect the HTTPS Port configuration set in System Maintenance>>Management . In general, the default setting is 443.
Server Certificate	When the client does not set any certificate, default certificate will be used for HTTPS and SSL VPN server. Choose any one of the user-defined certificates from the drop down list if users set several certificates previously. Otherwise, choose Self-signed to use the router's built-in default certificate. The default certificate can be used in SSL VPN server and HTTPS Web Proxy.

After finishing all the settings here, please click **OK** to save the configuration.

IV-2-2 User Account

With SSL VPN, VigorLTE 200 series let teleworkers have convenient and simple remote access to central site VPN. The teleworkers do not need to install any VPN software manually. From regular web browser, you can establish VPN connection back to your main office even in a guest network or web cafe. The SSL technology is the same as the encryption that you use for secure web sites such as your online bank. The SSL VPN can be operated in either full tunnel mode or proxy mode. Now, VigorLTE 200 series allows up to 16 simultaneous incoming users.

For SSL VPN, identity authentication and power management are implemented through deploying user accounts. Therefore, the user account for SSL VPN must be set together with remote dial-in user web page. Such menu item will guide to access into VPN and Remote Access>>Remote Dial-in user.

VPN and Remote Access >> Remote Dial-in User



Remote Access User Accounts: [Set to Factory Default](#)

Index	Enable	User	Status	Index	Enable	User	Status
1.	<input type="checkbox"/>	???	---	17.	<input type="checkbox"/>	???	---
2.	<input type="checkbox"/>	???	---	18.	<input type="checkbox"/>	???	---
3.	<input type="checkbox"/>	???	---	19.	<input type="checkbox"/>	???	---
4.	<input type="checkbox"/>	???	---	20.	<input type="checkbox"/>	???	---
5.	<input type="checkbox"/>	???	---	21.	<input type="checkbox"/>	???	---
6.	<input type="checkbox"/>	???	---	22.	<input type="checkbox"/>	???	---
7.	<input type="checkbox"/>	???	---	23.	<input type="checkbox"/>	???	---
8.	<input type="checkbox"/>	???	---	24.	<input type="checkbox"/>	???	---
9.	<input type="checkbox"/>	???	---	25.	<input type="checkbox"/>	???	---
10.	<input type="checkbox"/>	???	---	26.	<input type="checkbox"/>	???	---
11.	<input type="checkbox"/>	???	---	27.	<input type="checkbox"/>	???	---
12.	<input type="checkbox"/>	???	---	28.	<input type="checkbox"/>	???	---
13.	<input type="checkbox"/>	???	---	29.	<input type="checkbox"/>	???	---
14.	<input type="checkbox"/>	???	---	30.	<input type="checkbox"/>	???	---
15.	<input type="checkbox"/>	???	---	31.	<input type="checkbox"/>	???	---
16.	<input type="checkbox"/>	???	---	32.	<input type="checkbox"/>	???	---

OK Cancel

Backup setting to file: <input type="button" value="Backup"/>	Restore From File: <input type="text" value="選擇檔案"/> 未選擇任何檔案 <input type="button" value="Restore"/>
--	--

Download Smart VPN Client:

[Smart VPN Client for Windows PC](#)

[Smart VPN Android/iOS App](#)

Click each index to edit one remote user profile.

VPN and Remote Access >> Remote Dial-in User

Index No. 1

User account and Authentication <input type="checkbox"/> Enable this account Idle Timeout <input type="text" value="300"/> second(s)		Username <input type="text" value="???"/> Password <input type="text" value="Max: 19 characters"/> <input type="checkbox"/> Enable Mobile One-Time Passwords(mOTP) PIN <input type="text"/> Code <input type="text"/> Secret <input type="text"/>
Allowed Dial-In Type <input checked="" type="checkbox"/> PPTP <input checked="" type="checkbox"/> IPsec Tunnel <input checked="" type="checkbox"/> L2TP with IPsec Policy <input type="text" value="None"/> <input checked="" type="checkbox"/> SSL Tunnel <input checked="" type="checkbox"/> IPsec XAuth <input type="checkbox"/> Specify Remote Node Remote Client IP <input type="text"/> or Peer ID <input type="text"/> Netbios Naming Packet <input checked="" type="radio"/> Pass <input type="radio"/> Block Multicast via VPN <input type="radio"/> Pass <input checked="" type="radio"/> Block (for some IGMP,IP-Camera,DHCP Relay..etc.)		IKE Authentication Method <input checked="" type="checkbox"/> Pre-Shared Key <input type="text" value="IKE Pre-Shared Key"/> <input type="text" value="Max: 64 characters"/> <input type="checkbox"/> Digital Signature(X.509) <input type="text" value="None"/>
Subnet <input type="text" value="LAN 1"/> <input type="checkbox"/> Assign Static IP Address <input type="text" value="0.0.0.0"/>		IPsec Security Method <input checked="" type="checkbox"/> Medium(AH) High(ESP) <input checked="" type="checkbox"/> DES <input checked="" type="checkbox"/> 3DES <input checked="" type="checkbox"/> AES Local ID (optional) <input type="text"/>

Note:
Username can not contain characters " and '.

OK Clear Cancel

Available settings are explained as follows:

Item	Description
User account and Authentication	<p>Enable this account - Check the box to enable this function.</p> <p>Idle Timeout- If the dial-in user is idle over the limitation of the timer, the router will drop this connection. By default, the Idle Timeout is set to 300 seconds.</p> <p>Username - This field is applicable when you select PPTP or L2TP with or without IPsec policy above. The length of the name/password is limited to 23 characters.</p> <p>Password - This field is applicable when you select PPTP or L2TP with or without IPsec policy above. The length of the name/password is limited to 19 characters.</p> <p>Enable Mobile One-Time Passwords (mOTP) - Check this box to make the authentication with mOTP function.</p> <p>PIN Code - Enter the code for authentication (e.g, 1234).</p> <p>Secret - Use the 32 digit-secret number generated by mOTP in the mobile phone (e.g., e759bb6f0e94c7ab4fe6).</p>
Allowed Dial-In Type	<p>PPTP - Allow the remote dial-in user to make a PPTP VPN connection through the Internet. You should set the User Name and Password of remote dial-in user below.</p> <p>IPSec Tunnel - Allow the remote dial-in user to make an IPsec VPN connection through Internet.</p>

Item	Description
	<p>L2TP with IPsec Policy - Allow the remote dial-in user to make a L2TP VPN connection through the Internet. You can select to use L2TP alone or with IPsec. Select from below:</p> <ul style="list-style-type: none"> ● None - Do not apply the IPsec policy. Accordingly, the VPN connection employed the L2TP without IPsec policy can be viewed as one pure L2TP connection. ● Nice to Have - Apply the IPsec policy first, if it is applicable during negotiation. Otherwise, the dial-in VPN connection becomes one pure L2TP connection. ● Must -Specify the IPsec policy to be definitely applied on the L2TP connection. <p>SSL Tunnel - It allows the remote dial-in user to make an SSL VPN Tunnel connection through Internet, suitable for the application through network accessing (e.g., PPTP / L2TP / IPsec).</p> <p>If you check this box, the function of SSL Tunnel for this account will be activated immediately.</p> <p>IPsec XAuth - Allow the remote dial-in user to make an IPsec VPN connection through XAuth server in Internet.</p> <p>Specify Remote Node - Check the checkbox to specify the IP address of the remote dial-in user, ISDN number or peer ID (used in IKE aggressive mode). If you uncheck the checkbox, the connection type you select above will apply the authentication methods and security methods in the general settings.</p> <p>Netbios Naming Packet</p> <ul style="list-style-type: none"> ● Pass - Click it to have an inquiry for data transmission between the hosts located on both sides of VPN Tunnel while connecting. ● Block - When there is conflict occurred between the hosts on both sides of VPN Tunnel in connecting, such function can block data transmission of Netbios Naming Packet inside the tunnel. <p>Multicast via VPN - Some programs might send multicast packets via VPN connection.</p> <ul style="list-style-type: none"> ● Pass - Click this button to let multicast packets pass through the router. ● Block - This is default setting. Click this button to let multicast packets be blocked by the router.
Subnet	<p>Chose one of the subnet selections for such VPN profile.</p> <p>Assign Static IP Address - Please type a static IP address for the subnet you specified.</p>
IKE Authentication Method	<p>This group of fields is applicable for IPsec Tunnels and L2TP with IPsec Policy when you specify the IP address of the remote node. The only exception is Digital Signature (X.509) can be set when you select IPsec tunnel either with or without specify the IP address of the remote node.</p> <p>Pre-Shared Key - Check the box of Pre-Shared Key to invoke this function and Enter the required characters (1-63) as the pre-shared key.</p> <p>Digital Signature (X.509) - Check the box of Digital Signature to invoke this function and Select one predefined Profiles set in the VPN and Remote Access >>IPsec Peer Identity.</p>

Item	Description
IPSec Security Method	<p>This group of fields is a must for IPSec Tunnels and L2TP with IPSec Policy when you specify the remote node. Check the Medium, DES, 3DES or AES box as the security method.</p> <p>Medium-Authentication Header (AH) means data will be authenticated, but not be encrypted. By default, this option is invoked. You can uncheck it to disable it.</p> <p>High(ESP-Encapsulating Security Payload) means payload (data) will be encrypted and authenticated. You may select encryption algorithm from Data Encryption Standard (DES), Triple DES (3DES), and AES.</p> <p>Local ID - Specify a local ID to be used for Dial-in setting in the LAN-to-LAN Profile setup. This item is optional and can be used only in IKE aggressive mode.</p>

After finishing all the settings here, please click **OK** to save the configuration.

IV-2-3 SSL Portal Online User

If you have finished the configuration of SSL Web Proxy (server), users can find out corresponding settings when they access into DrayTek SSL VPN portal interface.

The screenshot shows the DrayTek SSL VPN portal interface. At the top left is the DrayTek logo. Below it, the text 'Provide SSL VPN' is visible. The main navigation bar includes 'Home', 'SSL Web Proxy', and 'SSL Tunnel', with a '[logout]' link on the right. The main content area displays a welcome message: 'You have successfully logged in! You are given the following privileges:'. Below this, two links are listed: 'SSL Web Proxy' and 'SSL Tunnel'. On the left side, there is an 'INFO' box containing the user's name 'mike', IP address '(172.17.1.42)', and a 'Welcome to DrayTek SSL VPN!' message. Below the info box, it says 'Timeout after 5 minutes.' with a '[Reset]' link. At the bottom right of the page, the copyright notice 'Copyright © 2006, DrayTek Corp. All Rights Reserved.' is present.

Next, users can open **SSL VPN >> Online Status** to view logging status of SSL VPN.

SSL VPN >> Online User Status

Refresh Seconds :

Active User	Host IP	Time out(seconds)	Action
Kate	192.168.30.14	299	<input type="button" value="Drop"/>

Available settings are explained as follows:

Item	Description
Active User	Display current user who visits SSL VPN server.
Host IP	Display the IP address for the host.
Time out	Display the time remaining for logging out.
Action	You can click Drop to drop certain login user from the router's SSL Portal UI.

IV-3 Certificate Management

A digital certificate works as an electronic ID, which is issued by a certification authority (CA). It contains information such as your name, a serial number, expiration dates etc., and the digital signature of the certificate-issuing authority so that a recipient can verify that the certificate is real. Here Vigor router support digital certificates conforming to standard X.509.

Any entity wants to utilize digital certificates should first request a certificate issued by a CA server. It should also retrieve certificates of other trusted CA servers so it can authenticate the peer with certificates issued by those trusted CA servers.

Here you can manage generate and manage the local digital certificates, and set trusted CA certificates. Remember to adjust the time of Vigor router before using the certificate so that you can get the correct valid period of certificate.

Below shows the menu items for Certificate Management.

Web User Interface

VPN and Remote Access
Certificate Management
Local Certificate
Trusted CA Certificate
Certificate Backup
SSL VPN

IV-3-1 Local Certificate

Certificate Management >> Local Certificate

X509 Local Certificate Configuration

Name	Subject	Status	Modify	
---	---	---	<input type="button" value="View"/>	<input type="button" value="Delete"/>
---	---	---	<input type="button" value="View"/>	<input type="button" value="Delete"/>
---	---	---	<input type="button" value="View"/>	<input type="button" value="Delete"/>

Note:

1. Please setup the "System Maintenance >> **Time and Date**" correctly before signing the local certificate.
2. The Time Zone MUST be setup correctly!!

Available settings are explained as follows:

Item	Description
Generate	Click this button to open Generate Certificate Request window. Enter all the information that the window requests. Then click Generate again.
Import	Click this button to import a saved file as the certification information.
Refresh	Click this button to refresh the information listed below.
View	Click this button to view the detailed settings for certificate request.
Delete	Click this button to delete selected name with certification information.

GENERATE

Click this button to open **Generate Certificate Signing Request** window. Enter all the information that the window request such as certificate name (used for identifying different certificate), subject alternative name type and relational settings for subject name. Then click **GENERATE** again.

Generate Certificate Signing Request

Certificate Name	<input type="text"/>
Subject Alternative Name	
Type	IP Address ▼
IP	<input type="text"/>
Subject Name	
Country (C)	<input type="text"/>
State (ST)	<input type="text"/>
Location (L)	<input type="text"/>
Organization (O)	<input type="text"/>
Organization Unit (OU)	<input type="text"/>
Common Name (CN)	<input type="text"/>
Email (E)	<input type="text"/>
Key Type	RSA ▼
Key Size	1024 Bit ▼
Algorithm	SHA-256 ▼

Generate



Info

Please be noted that "Common Name" must be configured with router's WAN IP or domain name.

After clicking **GENERATE**, the generated information will be displayed on the window below:

X509 Local Certificate Configuration

Name	Subject	Status	Modify	
server	/C=TW/ST=Hsinchu/L=Hsinchu/O...	Requesting	View	Delete
---	---	---	View	Delete
---	---	---	View	Delete

[GENERATE](#) [IMPORT](#) [REFRESH](#)

IMPORT

Vigor router allows you to generate a certificate request and submit it the CA server, then import it as "Local Certificate". If you have already gotten a certificate from a third party, you may import it directly. The supported types are PKCS12 Certificate and Certificate with a private key.

Click this button to import a saved file as the certification information. There are three types of local certificate supported by Vigor router.

Import X509 Local Certificate

Upload Local Certificate
 Select a local certificate file.
 Certificate file:
 Click **Import** to upload the local certificate.

Upload PKCS12 Certificate
 Select a PKCS12 file.
 PKCS12 file:
 Password:
 Click **Import** to upload the PKCS12 file.

Upload Certificate and Private Key
 Select a certificate file and a matchable Private Key.
 Certificate file:
 Key file:
 Password:
 Click **Import** to upload the local certificate and private key.

Available settings are explained as follows:

Item	Description																				
Upload Local Certificate	<p>It allows users to import the certificate which is generated by Vigor router and signed by CA server.</p> <p>If you have done well in certificate generation, the Status of the certificate will be shown as "OK".</p> <div style="border: 1px solid gray; padding: 5px; margin: 5px 0;"> <p style="color: red; font-size: small;">Import X509 Local Certificate</p> <p style="text-align: center;">Congratulation!</p> <p style="text-align: center; font-size: x-small;">Local Certificate has been imported successfully.</p> <p style="text-align: center; font-size: x-small;">Please click <input type="button" value="Back"/> to view the certificate.</p> </div> <div style="border: 1px solid gray; padding: 5px; margin: 5px 0;"> <p style="color: red; font-size: small;">X509 Local Certificate Configuration</p> <table border="1" style="width: 100%; border-collapse: collapse; text-align: center;"> <thead> <tr> <th style="color: red;">Name</th> <th style="color: red;">Subject</th> <th style="color: red;">Status</th> <th colspan="2" style="color: red;">Modify</th> </tr> </thead> <tbody> <tr> <td>draytekdemo</td> <td>/O=Draytek/OU=Draytek Sales/...</td> <td>OK</td> <td><input type="button" value="View"/></td> <td><input type="button" value="Delete"/></td> </tr> <tr> <td>---</td> <td>---</td> <td>---</td> <td><input type="button" value="View"/></td> <td><input type="button" value="Delete"/></td> </tr> <tr> <td>---</td> <td>---</td> <td>---</td> <td><input type="button" value="View"/></td> <td><input type="button" value="Delete"/></td> </tr> </tbody> </table> <p style="text-align: center; font-size: x-small;"> <input type="button" value="GENERATE"/> <input type="button" value="IMPORT"/> <input type="button" value="REFRESH"/> </p> </div>	Name	Subject	Status	Modify		draytekdemo	/O=Draytek/OU=Draytek Sales/...	OK	<input type="button" value="View"/>	<input type="button" value="Delete"/>	---	---	---	<input type="button" value="View"/>	<input type="button" value="Delete"/>	---	---	---	<input type="button" value="View"/>	<input type="button" value="Delete"/>
Name	Subject	Status	Modify																		
draytekdemo	/O=Draytek/OU=Draytek Sales/...	OK	<input type="button" value="View"/>	<input type="button" value="Delete"/>																	
---	---	---	<input type="button" value="View"/>	<input type="button" value="Delete"/>																	
---	---	---	<input type="button" value="View"/>	<input type="button" value="Delete"/>																	
Upload PKCS12 Certificate	<p>It allows users to import the certificate whose extensions are usually .pfx or .p12. And these certificates usually need passwords.</p> <p>Note that PKCS12 is a standard for storing private keys and certificates securely. It is used in (among other things) Netscape and Microsoft Internet Explorer with their import and export options.</p>																				
Upload Certificate and Private Key	<p>It is useful when users have separated certificates and private keys. And the password is needed if the private key is encrypted.</p>																				

REFRESH

Click this button to refresh the information listed below.

View

Click this button to view the detailed settings for certificate request.

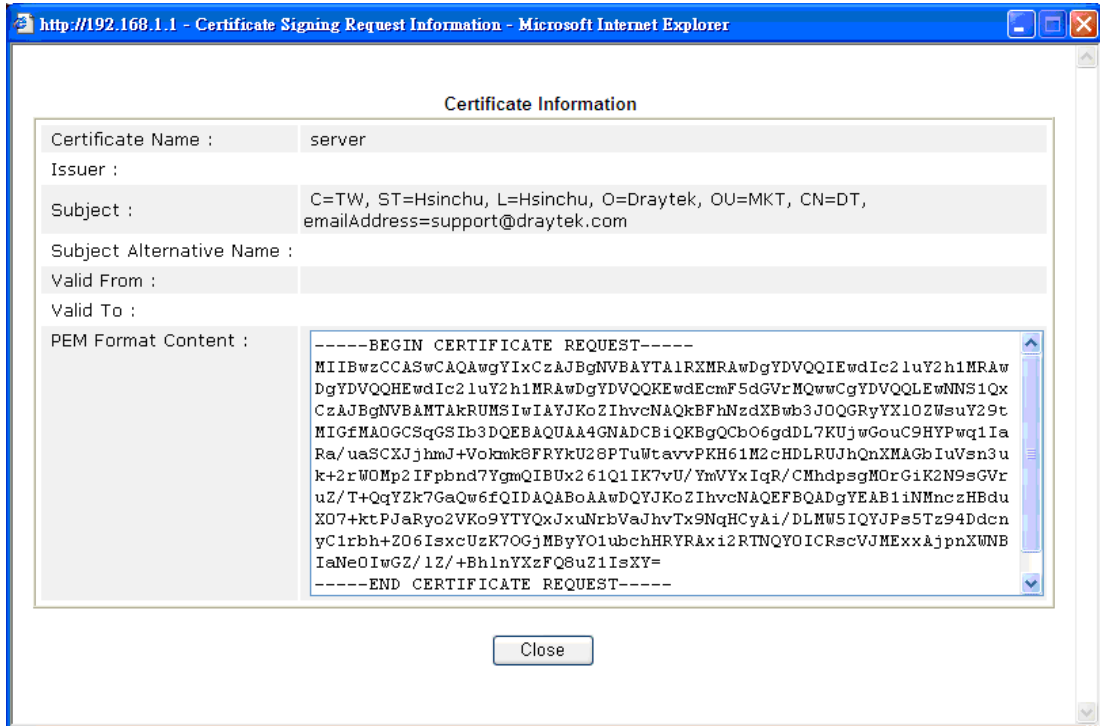

Info

You have to copy the certificate request information from above window. Next, access your CA server and enter the page of certificate request, copy the information into it and submit a request. A new certificate will be issued to you by the CA server. You can save it.

Delete

Click this button to remove the selected certificate.

IV-3-2 Trusted CA Certificate

Trusted CA certificate lists three sets of trusted CA certificate. In addition, you can build a RootCA certificate if required.

When the local client and remote client are required to make certificate authentication (e.g., IPsec X.509) for data passing through SSL tunnel and avoiding the attack of MITM, a trusted root certificate authority (Root CA) will be used to authenticate the digital certificates offered by both ends.

However, the procedure of applying digital certificate from a trusted root certificate authority is complicated and time-consuming. Therefore, Vigor router offers a mechanism which allows you to generate root CA to save time and provide convenience for general user. Later, such root CA generated by DrayTek server can perform the issuing of local certificate.



Info

Root CA can be deleted but not edited. If you want to modify the settings for a Root CA, please delete the one and create another one by clicking Create Root CA.

Certificate Management >> Trusted CA Certificate

X509 Trusted CA Certificate Configuration

Name	Subject	Status	Modify
Root CA	---	---	<input type="button" value="Create"/>
Trusted CA-1	---	---	<input type="button" value="View"/> <input type="button" value="Delete"/>
Trusted CA-2	---	---	<input type="button" value="View"/> <input type="button" value="Delete"/>
Trusted CA-3	---	---	<input type="button" value="View"/> <input type="button" value="Delete"/>

Note:

1. Please setup the "System Maintenance >> **Time and Date**" correctly before you try to generate a RootCA!!
2. The Time Zone MUST be setup correctly!!

Creating a Root CA

Click Create to open the following page. Enter all the information that the window request such as certificate name (used for identifying different certificate), subject alternative name type and relational settings for subject name. Then click **Generate** again.

Generate Root CA

Certificate Name	Root CA
Subject Alternative Name	
Type	IP Address ▾
IP	<input type="text"/>
Subject Name	
Country (C)	<input type="text"/>
State (ST)	<input type="text"/>
Location (L)	<input type="text"/>
Organization (O)	<input type="text"/>
Organization Unit (OU)	<input type="text"/>
Common Name (CN)	<input type="text"/>
Email (E)	<input type="text"/>
Key Type	RSA ▾
Key Size	1024 Bit ▾
Algorithm	SHA-256 ▾

Importing a Trusted CA

To import a pre-saved trusted CA certificate, please click **IMPORT** to open the following window. Use **Browse...** to find out the saved text file. Then click **Import**. The one you imported will be listed on the Trusted CA Certificate window.

Import X509 Trusted CA Certificate

Select a trusted CA certificate file.

Click **Import** to upload the certification.

For viewing each trusted CA certificate, click **View** to open the certificate detail information window. If you want to delete a CA certificate, choose the one and click **Delete** to remove all the certificate information.

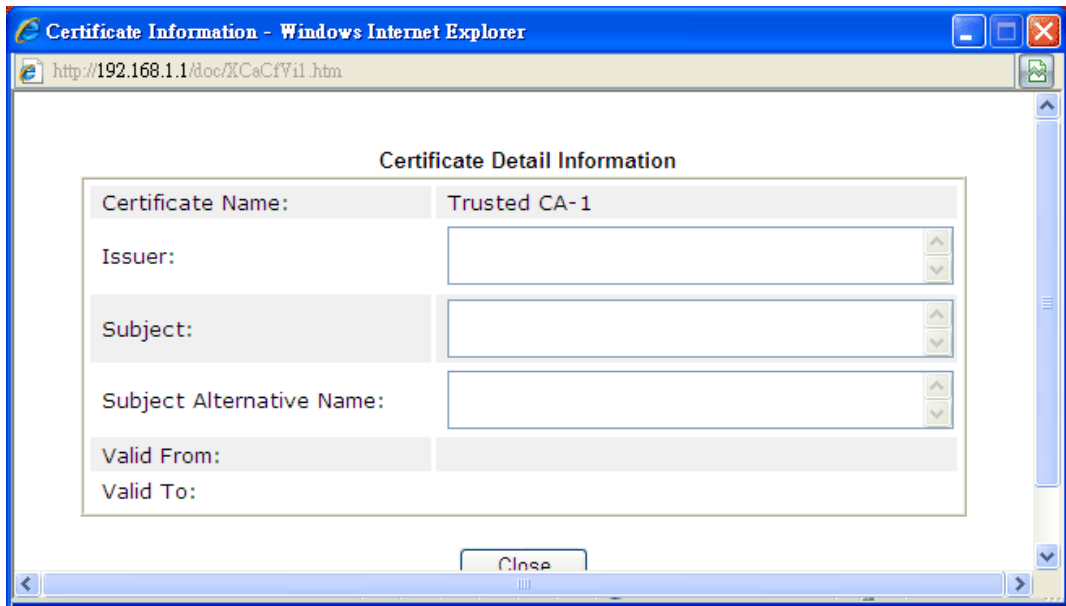

IV-3-3 Certificate Backup

Local certificate and Trusted CA certificate for this router can be saved within one file. Please click **Backup** on the following screen to save them. If you want to set encryption password for these certificates, please type characters in both fields of **Encrypt password** and **Confirm password**.

Also, you can use **Restore** to retrieve these two settings to the router whenever you want.

Certificate Management >> Certificate Backup

Certificate Backup / Restoration

Backup

Encrypt password:

Confirm password:

Click to download certificates to your local PC as a file.

Restoration

Select a backup file to restore.

Decrypt password:

Click to upload the file.

Part V Security



Firewall



CSM

While the broadband users demand more bandwidth for multimedia, interactive applications, or distance learning, security has been always the most concerned. The firewall of the Vigor router helps to protect your local network against attack from unauthorized outsiders. It also restricts users in the local network from accessing the Internet.

CSM is an abbreviation of Central Security Management which is used to control IM/P2P usage, filter the web content and URL content to reach a goal of security management.

V-1 Firewall

While the broadband users demand more bandwidth for multimedia, interactive applications, or distance learning, security has been always the most concerned. The firewall of the Vigor router helps to protect your local network against attack from unauthorized outsiders. It also restricts users in the local network from accessing the Internet. Furthermore, it can filter out specific packets that trigger the router to build an unwanted outgoing connection.

Firewall Facilities

The users on the LAN are provided with secured protection by the following firewall facilities:

- User-configurable IP filter (Call Filter/ Data Filter).
- Stateful Packet Inspection (SPI): tracks packets and denies unsolicited incoming data
- Selectable Denial of Service (DoS) /Distributed DoS (DDoS) attacks protection

IP Filters

Depending on whether there is an existing Internet connection, or in other words “the WAN link status is up or down”, the IP filter architecture categorizes traffic into two: Call Filter and Data Filter.

- **Call Filter** - When there is no existing Internet connection, Call Filter is applied to all traffic, all of which should be outgoing. It will check packets according to the filter rules. If legal, the packet will pass. Then the router shall “initiate a call” to build the Internet connection and send the packet to Internet.
- **Data Filter** - When there is an existing Internet connection, Data Filter is applied to incoming and outgoing traffic. It will check packets according to the filter rules. If legal, the packet will pass the router.

The following illustrations are flow charts explaining how router will treat incoming traffic and outgoing traffic respectively.

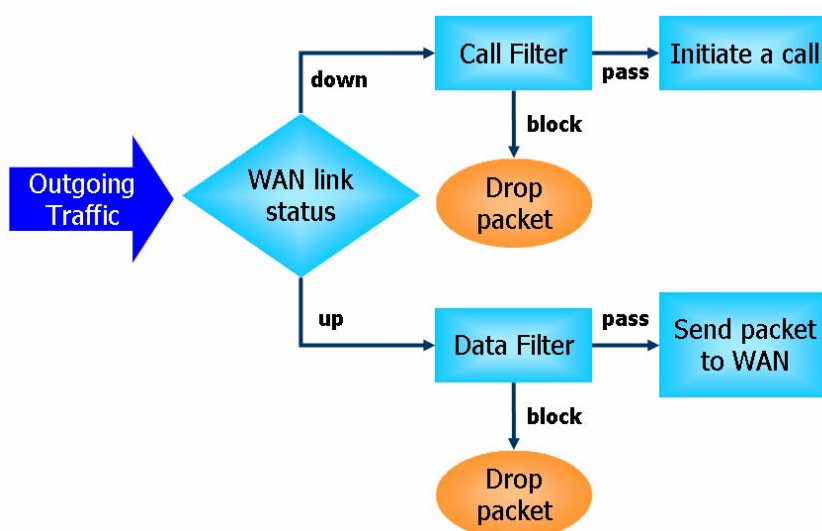

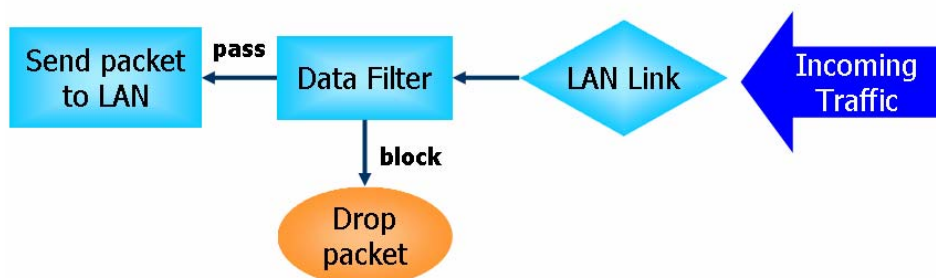

Stateful Packet Inspection (SPI)

Stateful inspection is a firewall architecture that works at the network layer. Unlike legacy static packet filtering, which examines a packet based on the information in its header, stateful inspection builds up a state machine to track each connection traversing all interfaces of the firewall and makes sure they are valid. The stateful firewall of Vigor router not only examines the header information also monitors the state of the connection.

Denial of Service (DoS) Defense

The DoS Defense functionality helps you to detect and mitigate the DoS attack. The attacks are usually categorized into two types, the flooding-type attacks and the vulnerability attacks. The flooding-type attacks will attempt to exhaust all your system's resource while the vulnerability attacks will try to paralyze the system by offending the vulnerabilities of the protocol or operation system.

The DoS Defense function enables the Vigor router to inspect every incoming packet based on the attack signature database. Any malicious packet that might duplicate itself to paralyze the host in the secure LAN will be strictly blocked and a Syslog message will be sent as warning, if you set up Syslog server.

Also the Vigor router monitors the traffic. Any abnormal traffic flow violating the pre-defined parameter, such as the number of thresholds, is identified as an attack and the Vigor router will activate its defense mechanism to mitigate in a real-time manner.

The below shows the attack types that DoS/DDoS defense function can detect:

- | | |
|----------------------|--------------------------|
| 1. SYN flood attack | 9. SYN fragment |
| 2. UDP flood attack | 10. Fraggle attack |
| 3. ICMP flood attack | 11. TCP flag scan |
| 4. Port Scan attack | 12. Tear drop attack |
| 5. IP options | 13. Ping of Death attack |
| 6. Land attack | 14. ICMP fragment |
| 7. Smurf attack | 15. Unassigned Numbers |
| 8. Trace route | |

Web User Interface

Below shows the menu items for Firewall.

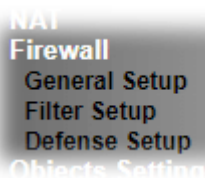

V-1-1 General Setup

General Setup allows you to adjust settings of IP Filter and common options. Here you can enable or disable the **Call Filter** or **Data Filter**. Under some circumstance, your filter set can be linked to work in a serial manner. So here you assign the **Start Filter Set** only. Also you can configure the **Log Flag** settings, **Apply IP filter to VPN incoming packets**, and **Accept incoming fragmented UDP packets**.

Click **Firewall** and click **General Setup** to open the general setup page.

General Setup Page

Such page allows you to enable / disable Call Filter and Data Filter, determine general rule for filtering the incoming and outgoing data.

Firewall >> General Setup

General Setup

General Setup	Default Rule
<p>Call Filter</p> <p> <input checked="" type="radio"/> Enable Start Filter Set: <input type="text" value="Set#1"/> <input type="radio"/> Disable </p> <p>Data Filter</p> <p> <input checked="" type="radio"/> Enable Start Filter Set: <input type="text" value="Set#2"/> <input type="radio"/> Disable </p> <hr/> <p> <input checked="" type="checkbox"/> Always pass inbound fragmented large packets (required for certain games and streaming) </p> <p> <input checked="" type="checkbox"/> Enable Strict Security Firewall </p> <p> Block connections initiated from WAN <input type="checkbox"/> IPv4 <input checked="" type="checkbox"/> IPv6 </p>	

Note:

Packets are filtered by firewall functions in the following order:
 1.Data Filter Sets and Rules 2.Block connections initiated from WAN 3.Default Rule

Backup Firewall : <input type="button" value="Backup"/>	Restore Firewall: <input type="button" value="選擇檔案"/> 未選擇任何檔案 <input type="button" value="Restore"/>
---	--

Note:

This will not backup the detail setting of Quality of Service and Schedule.

Available settings are explained as follows:

Item	Description
Call Filter	Check Enable to activate the Call Filter function. Assign a start filter set for the Call Filter.

Data Filter	Check Enable to activate the Data Filter function. Assign a start filter set for the Data Filter.
Always pass inbound fragmented large packets...	Some on-line games (for example: Half Life) will use lots of fragmented UDP packets to transfer game data. Instinctively as a secure firewall, Vigor router will reject these fragmented packets to prevent attack unless you enable " Always pass inbound fragmented large packets... ". By checking this box, you can play these kinds of on-line games. If security concern is in higher priority, you cannot enable " Always pass inbound fragmented large packets... ".
Enable Strict Security Firewall	For the sake of security, the router will execute strict security checking for data transmission. Such feature is enabled in default. All the packets, while transmitting through Vigor router, will be filtered by firewall. If the firewall system (e.g., content filter server) does not make any response (pass or block) for these packets, then the router's firewall will block the packets directly.
Block routing connections initiated from WAN	Usually, IPv6 network sessions/traffic from WAN to LAN will be accepted by IPv6 firewall in default. IPv6 - To prevent remote client accessing into the PCs on LAN, check the box to make the packets (routed from WAN to LAN) via IPv6 being blocked by such router. It is effective only for the packets routed but not for packets translated by NAT. IPv4 - To prevent remote client accessing into the PCs on LAN, check the box to make the incoming packets via IPv4 being blocked by such router. It is effective only for the packets routed but not for packets translated by NAT.
Backup Firewall	Click Backup to save the firewall configuration.
Restore Firewall	Click Select to choose a firewall configuration file. Then click Restore to apply the file.

Default Rule Page

Such page allows you to choose filtering profiles including QoS, Load-Balance policy, WCF, APP Enforcement, URL Content Filter, for data transmission via Vigor router.

Firewall >> General Setup

General Setup

General Setup
Default Rule

Actions for default rule:

Application	Action/Profile	Syslog
Filter	Pass ▼	<input type="checkbox"/>
Sessions Control	0 / 30000	<input type="checkbox"/>
Quality of Service	None ▼	<input type="checkbox"/>
APP Enforcement	None ▼	<input type="checkbox"/>
URL Content Filter	None ▼	<input type="checkbox"/>
Web Content Filter	None ▼	<input type="checkbox"/>

Advance Setting Edit

OK Cancel

Backup Firewall : Backup

Restore Firewall: 選擇檔案 未選擇任何檔案

Restore

Note:

This will not backup the detail setting of Quality of Service and Schedule.

Available settings are explained as follows:

Item	Description
Filter	Select Pass or Block for the packets that do not match with the filter rules.
Sessions Control	The number typed here is the total sessions of the packets that do not match the filter rule configured in this page. The default setting is 60000.
Quality of Service	Choose one of the QoS rules to be applied as firewall rule. For detailed information of setting QoS, please refer to the related section later.
APP Enforcement	Select an APP Enforcement profile for global IM/P2P application blocking. If there is no profile for you to select, please choose [Create New] from the drop down list in this page to create a new profile. All the hosts in LAN must follow the standard configured in the APP Enforcement profile selected here. For detailed information, refer to the section of APP Enforcement profile setup. For troubleshooting needs, you can specify to record information for IM/P2P by checking the Log box. It will be sent to Syslog server. Please refer to section Syslog/Mail Alert for more detailed information.

<p>URL Content Filter</p>	<p>Select one of the URL Content Filter profile settings (created in CSM>> URL Content Filter) for applying with this router. Please set at least one profile for choosing in CSM>> URL Content Filter web page first. Or choose [Create New] from the drop down list in this page to create a new profile. For troubleshooting needs, you can specify to record information for URL Content Filter by checking the Log box. It will be sent to Syslog server. Please refer to section Syslog/Mail Alert for more detailed information.</p>
<p>Web Content Filter</p>	<p>Select one of the Web Content Filter profile settings (created in CSM>> Web Content Filter) for applying with this router. Please set at least one profile for anti-virus in CSM>> Web Content Filter web page first. Or choose [Create New] from the drop down list in this page to create a new profile. For troubleshooting needs, you can specify to record information for Web Content Filter by checking the Log box. It will be sent to Syslog server. Please refer to section Syslog/Mail Alert for more detailed information.</p>
<p>Advance Setting</p>	<p>Click Edit to open the following window. However, it is strongly recommended to use the default settings here.</p> <p>Firewall >> General Setup</p> <div data-bbox="715 936 1385 1167" data-label="Image"> </div> <p>Codepage - This function is used to compare the characters among different languages. Choose correct codepage can help the system obtain correct ASCII after decoding data from URL and enhance the correctness of URL Content Filter. The default value for this setting is ANSI 1252 Latin I. If you do not choose any codepage, no decoding job of URL will be processed. Please use the drop-down list to choose a codepage.</p> <p>If you do not have any idea of choosing suitable codepage, please open Syslog. From Codepage Information of Setup dialog, you will see the recommended codepage listed on the dialog box.</p> <div data-bbox="703 1574 1401 1995" data-label="Image"> </div> <p>Window size - It determines the size of TCP protocol (0-65535). The more the value is, the better the</p>

	performance will be. However, if the network is not stable, small value will be proper. Session timeout - Setting timeout for sessions can make the best utilization of network resources.
Backup Firewall	Click Backup to save the firewall configuration.
Restore Firewall	Click Select to choose a firewall configuration file. Then click Restore to apply the file.

After finishing all the settings here, please click **OK** to save the configuration.

V-1-2 Filter Setup

Click Firewall and click Filter Setup to open the setup page.

Firewall >> Filter Setup

Filter Setup				Set to Factory Default
Set	Comments	Set	Comments	
1.	Default Call Filter	7.		
2.	Default Data Filter	8.		
3.		9.		
4.		10.		
5.		11.		
6.		12.		

To edit or add a filter, click on the set number to edit the individual set. The following page will be shown. Each filter set contains up to 7 rules. Click on the rule number button to edit each rule. Check **Active** to enable the rule.

Firewall >> Filter Setup >> Edit Filter Set

Filter Set 1
 Comments :

Rule	Enable	Comments	Direction	Src IP	Dst IP	Service Type	Action	CSM	Move Up	Move Down
1	<input checked="" type="checkbox"/>	Block NetBios	LAN/RT/VPN -> WAN	Any	Any	TCP/UDP, Port: from 137~139 to any	Block Immediately			Down
2	<input type="checkbox"/>		LAN/RT/VPN -> WAN	Any	Any	Any	Pass Immediately		UP	Down
3	<input type="checkbox"/>		LAN/RT/VPN -> WAN	Any	Any	Any	Pass Immediately		UP	Down
4	<input type="checkbox"/>		LAN/RT/VPN -> WAN	Any	Any	Any	Pass Immediately		UP	Down
5	<input type="checkbox"/>		LAN/RT/VPN -> WAN	Any	Any	Any	Pass Immediately		UP	Down
6	<input type="checkbox"/>		LAN/RT/VPN -> WAN	Any	Any	Any	Pass Immediately		UP	Down
7	<input type="checkbox"/>		LAN/RT/VPN -> WAN	Any	Any	Any	Pass Immediately		UP	

Filter Set [1](#) [2](#) [3](#) [4](#) [5](#) [6](#) [7](#) [8](#) [9](#) [10](#) [11](#) [12](#) Next Filter Set

Wizard Mode: most frequently used settings in three pages
 Advance Mode: all settings in one page

Available settings are explained as follows:

Item	Description
Rule	Click a button numbered (1 ~ 7) to edit the filter rule. Click the button will open Edit Filter Rule web page. For the detailed information, refer to the following page.
Enable	Check the box to enable the filter rule.
Comments	Enter filter set comments/description. Maximum length is 23-character long.
Direction	Display the direction of packet.
Src IP / Dst IP	Display the IP address of source /destination.
Service Type	Display the type and port number of the packet.

Action	Display the packets to be passed /blocked.
CSM	Display the content security managed
Move Up/Down	Use Up or Down link to move the order of the filter rules.
Next Filter Set	Set the link to the next filter set to be executed after the current filter run. Do not make a loop with many filter sets.
Wizard Mode	Allow to configure frequently used settings for filter rule via several setting pages.
Advance Mode	Allow to configure detailed settings of filter rule.

To use Wizard Mode, simple do the following steps:

1. Click the **Wizard Mode** radio button.
2. Click **Index 1**. The setting page will appear as follows:

Firewall >> Edit Filter Set >> Edit Filter Rule Wizard

Filter Set 1 Rule 1

Firewall Rule applies to packets that meet the following criteria

Comments:

Direction:

Source IP:

Start IP Address:

End IP Address:

Subnet Mask:

Destination IP:

Start IP Address:

End IP Address:

Subnet Mask:

Protocol:

Source Port:

Destination Port:

Available settings are explained as follows:

Item	Description
Comments	Enter filter set comments/description. Maximum length is 14- character long.
Direction	Set the direction of packet flow. It is for Data Filter only. For the Call Filter , this setting is not available since Call Filter is only applied to outgoing traffic. Note: RT means routing domain for 2nd subnet or other LAN.

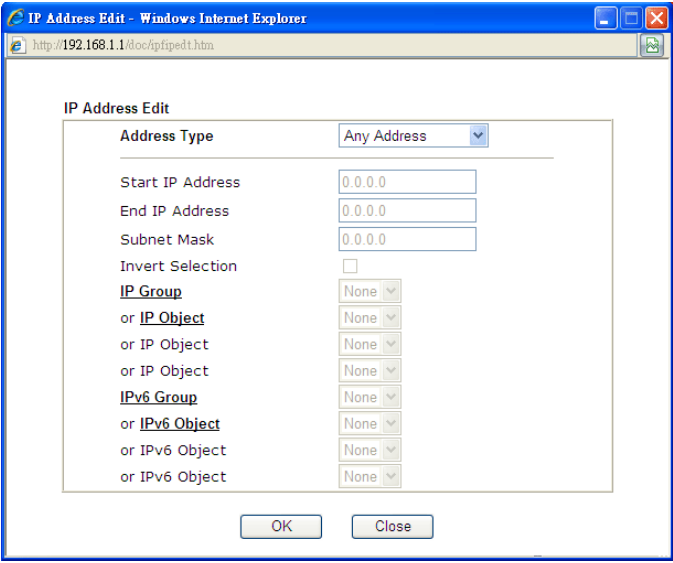
Source/Destination IP	<p>Click Edit to access into the following dialog to choose the source/destination IP or IP ranges.</p> 
Protocol	Specify the protocol(s) which this filter rule will apply to.
Source Port / Destination Port	<p>(=) - when the first and last value are the same, it indicates one port; when the first and last values are different, it indicates a range for the port and available for this service type.</p> <p>(!=) - when the first and last value are the same, it indicates all the ports except the port defined here; when the first and last values are different, it indicates that all the ports except the range defined here are available for this service type.</p> <p>(>) - the port number greater than this value is available.</p> <p>(<) - the port number less than this value is available for this profile.</p>

3. Click **Next** to get the following page.

Firewall >> Edit Filter Set >> Edit Filter Rule Wizard

Filter Set 1 Rule 1

Based on the settings in the previous pages, we guess you want to have: **Pass**
The current setting is :

Pass Immediately
APP Enforcement: None
URL Content Filter: None
Web Content Filter: None

Block Immediately

Buttons: Back, Next, Finish, Cancel

Available settings are explained as follows:

Item	Description
Pass Immediately	Packets matching the rule will be passed immediately. APP Enforcement - Select an APP Enforcement profile for global IM/P2P application blocking. If there is no profile for you to select, please choose [Create New] from the drop

	<p>down list in this page to create a new profile. All the hosts in LAN must follow the standard configured in the APP Enforcement profile selected here. For detailed information, refer to the section of APP Enforcement profile setup. For troubleshooting needs, you can specify to record information for IM/P2P by checking the Log box. It will be sent to Syslog server. Please refer to section Syslog/Mail Alert for more detailed information.</p> <p>URL Content Filter - Select one of the URL Content Filter profile settings (created in CSM>> URL Content Filter) for applying with this router. Please set at least one profile for choosing in CSM>> URL Content Filter web page first. Or choose [Create New] from the drop down list in this page to create a new profile. For troubleshooting needs, you can specify to record information for URL Content Filter by checking the Log box. It will be sent to Syslog server. Please refer to section Syslog/Mail Alert for more detailed information.</p> <p>Web Content Filter - Select one of the Web Content Filter profile settings (created in CSM>> Web Content Filter) for applying with this router. Please set at least one profile for anti-virus in CSM>> Web Content Filter web page first. Or choose [Create New] from the drop down list in this page to create a new profile. For troubleshooting needs, you can specify to record information for Web Content Filter by checking the Log box. It will be sent to Syslog server. Please refer to section Syslog/Mail Alert for more detailed information.</p>
Block Immediately	Packets matching the rule will be dropped immediately.

4. After choosing the mechanism, click **Next** to get the summary page for reference.

Firewall >> Edit Filter Set >> Edit Filter Rule Wizard

Filter Set 1 Rule 1 Configuration Summary

Comments :	Block NetBios
Direction	
LAN/RT/VPN -> WAN	
Criteria	
Source IP	Any
Destination IP	Any
Protocol	TCP/UDP, Port: from 137 ~ 139 to any
More options	
Pass Immediately	
APP Enforcement :	None
URL Content Filter :	None
Web Content Filter :	None

5. If there is no error, click **Finish** to complete wizard setting.

To use **Advance Mode**, do the following steps:

1. Click the **Advance Mode** radio button.
2. Click **Index 1** to access into the following page.

Firewall >> Edit Filter Set >> Edit Filter Rule

Filter Set 1 Rule 1

Enable

Comments: Block NetBios

Schedule Profile: None, None, None, None

Clear sessions when schedule is ON

Direction: LAN/RT/VPN -> WAN [Advanced]

Source IP: Any [Edit]

Destination IP: Any [Edit]

Service Type: TCP/UDP, Port: from 137~139 to any [Edit]

Fragments: Don't Care

Application	Action/Profile	Syslog
Filter	Block Immediately	<input type="checkbox"/>
Branch to Other Filter Set	None	<input type="checkbox"/>
Sessions Control	0 / 30000	<input type="checkbox"/>
MAC Bind IP	Non-Strict	<input type="checkbox"/>
Quality of Service	None	<input type="checkbox"/>
APP Enforcement	None	<input type="checkbox"/>
URL Content Filter	None	<input type="checkbox"/>
Web Content Filter	None	<input type="checkbox"/>

Advance Setting [Edit]

OK Clear Cancel

Available settings are explained as follows:

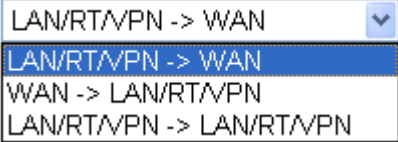
Item	Description
Enable	Check this box to enable the filter rule.
Comments	Enter filter set comments/description. Maximum length is 14- character long.
Schedule Profile	Set PCs on LAN to work at certain time interval only. You may choose up to 4 schedules out of the 15 schedules pre-defined in Applications >> Schedule setup. The default setting of this field is blank and the function will always work.
Clear sessions when schedule ON	Check this box to clear the sessions when the above schedule profiles are applied.
Direction	Set the direction of packet flow. It is for Data Filter only. For the Call Filter , this setting is not available since Call Filter is only applied to outgoing traffic.  Note: RT means routing domain for 2nd subnet or other LAN.
Source/Destination IP	Click Edit to access into the following dialog to choose the

source/destination IP or IP ranges.

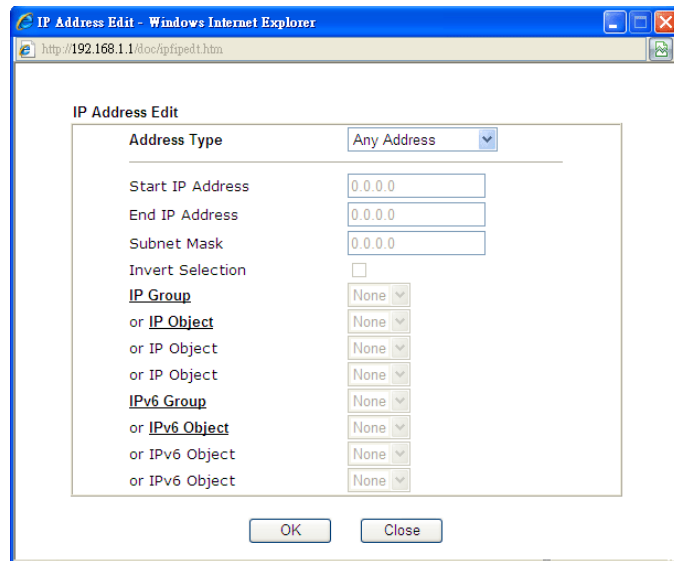

To set the IP address manually, please choose **Any Address/Single Address/Range Address/Subnet Address** as the Address Type and type them in this dialog. In addition, if you want to use the IP range from defined groups or objects, please choose **Group and Objects** as the Address Type.

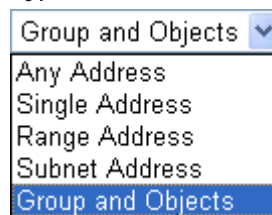

From the **IP Group** drop down list, choose the one that you want to apply. Or use the **IP Object** drop down list to choose the object that you want.

Service Type

Click **Edit** to access into the following dialog to choose a suitable service type.

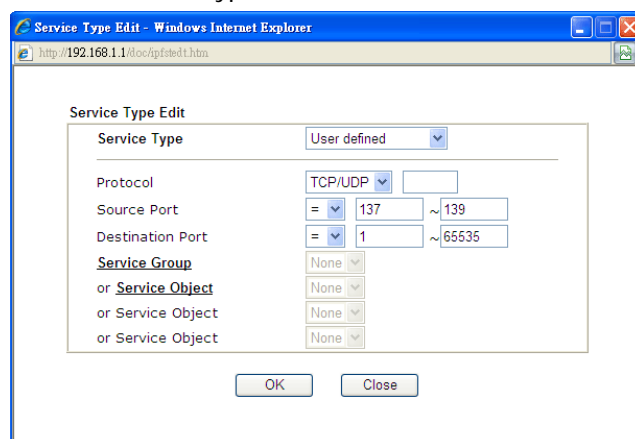

To set the service type manually, please choose **User defined** as the Service Type and type them in this dialog. In addition, if you want to use the service type from defined groups or objects, please choose **Group and Objects** as the Service Type.

	<div style="border: 1px solid black; padding: 2px;"> User defined ▼ User defined Group and Objects </div> <p>Protocol - Specify the protocol(s) which this filter rule will apply to.</p> <p>Source/Destination Port -</p> <p>(=) - when the first and last value are the same, it indicates one port; when the first and last values are different, it indicates a range for the port and available for this service type.</p> <p>(!=) - when the first and last value are the same, it indicates all the ports except the port defined here; when the first and last values are different, it indicates that all the ports except the range defined here are available for this service type.</p> <p>(>) - the port number greater than this value is available.</p> <p>(<) - the port number less than this value is available for this profile.</p> <p>Service Group/Object - Use the drop down list to choose the one that you want.</p>
Fragments	Specify the action for fragmented packets. And it is used for Data Filter only. <i>Don't care</i> -No action will be taken towards fragmented packets. <i>Unfragmented</i> -Apply the rule to unfragmented packets. <i>Fragmented</i> - Apply the rule to fragmented packets. <i>Too Short</i> - Apply the rule only to packets that are too short to contain a complete header.
Filter	Specifies the action to be taken when packets match the rule. Block Immediately - Packets matching the rule will be dropped immediately. Pass Immediately - Packets matching the rule will be passed immediately. Block If No Further Match - A packet matching the rule, and that does not match further rules, will be dropped. Pass If No Further Match - A packet matching the rule, and that does not match further rules, will be passed through.
Branch to other Filter Set	If the packet matches the filter rule, the next filter rule will branch to the specified filter set. Select next filter rule to branch from the drop-down menu. Be aware that the router will apply the specified filter rule for ever and will not return to previous filter rule any more.
Sessions Control	The number typed here is the total sessions of the packets that do not match the filter rule configured in this page. The default setting is 60000.
MAC Bind IP	Strict - Make the MAC address and IP address settings configured in IP Object for Source IP and Destination IP are bound for applying such filter rule. No-Strict - no limitation.
Quality of Service	Choose one of the QoS rules to be applied as firewall rule. For detailed information of setting QoS, please refer to the

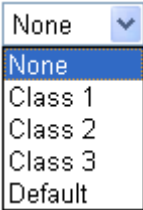
	<p>related section later.</p> 
<p>APP Enforcement</p>	<p>Select an APP Enforcement profile for global IM/P2P application blocking. If there is no profile for you to select, please choose [Create New] from the drop down list in this page to create a new profile. All the hosts in LAN must follow the standard configured in the APP Enforcement profile selected here. For detailed information, refer to the section of APP Enforcement profile setup. For troubleshooting needs, you can specify to record information for IM/P2P by checking the Log box. It will be sent to Syslog server. Please refer to section Syslog/Mail Alert for more detailed information.</p>
<p>URL Content Filter</p>	<p>Select one of the URL Content Filter profile settings (created in CSM>> URL Content Filter) for applying with this router. Please set at least one profile for choosing in CSM>> URL Content Filter web page first. Or choose [Create New] from the drop down list in this page to create a new profile. For troubleshooting needs, you can specify to record information for URL Content Filter by checking the Log box. It will be sent to Syslog server. Please refer to section Syslog/Mail Alert for more detailed information.</p>
<p>Web Content Filter</p>	<p>Select one of the Web Content Filter profile settings (created in CSM>> Web Content Filter) for applying with this router. Please set at least one profile for anti-virus in CSM>> Web Content Filter web page first. Or choose [Create New] from the drop down list in this page to create a new profile. For troubleshooting needs, you can specify to record information for Web Content Filter by checking the Log box. It will be sent to Syslog server. Please refer to section Syslog/Mail Alert for more detailed information.</p>
<p>Advance Setting</p>	<p>Click Edit to open the following window. However, it is strongly recommended to use the default settings here.</p> <p>Firewall >> Edit Filter Set >> Edit Filter Rule</p> <hr/> <p>Filter Set 1 Rule 1</p> <div data-bbox="715 1579 1385 1892"> <p>Advance Setting</p> <p>Codepage: <input type="text" value="ANSI(1252)-Latin I"/></p> <p>Window size: <input type="text" value="65535"/></p> <p>Session timeout: <input type="text" value="1440"/> Minute</p> <p>DrayTek Banner: <input checked="" type="checkbox"/></p> <hr/> <p>Strict Security Checking</p> <p><input type="checkbox"/> APP Enforcement</p> <p><input type="button" value="OK"/> <input type="button" value="Close"/></p> </div> <p>Codepage - This function is used to compare the characters among different languages. Choose correct codepage can help the system obtaining correct ASCII after decoding data from URL and enhance the correctness of URL Content Filter. The default value for this setting is ANSI 1252 Latin I.</p>

If you do not choose any codepage, no decoding job of URL will be processed. Please use the drop-down list to choose a codepage.

If you do not have any idea of choosing suitable codepage, please open Syslog. From Codepage Information of Setup dialog, you will see the recommended codepage listed on the dialog box.

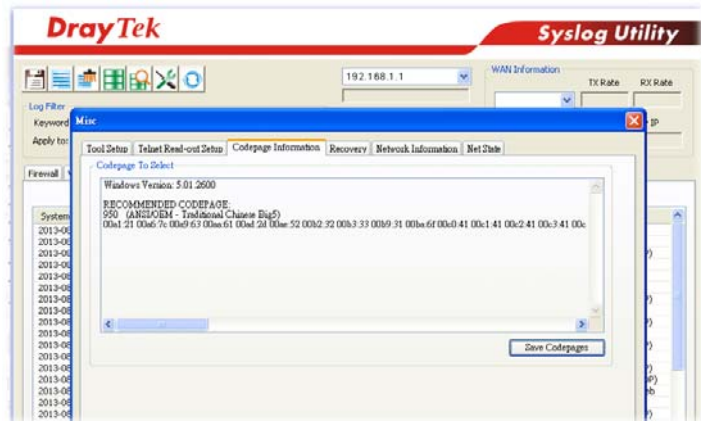

Window size - It determines the size of TCP protocol (0-65535). The more the value is, the better the performance will be. However, if the network is not stable, small value will be proper.

Session timeout-Setting timeout for sessions can make the best utilization of network resources. However, Queue timeout is configured for TCP protocol only; session timeout is configured for the data flow which matched with the firewall rule.

DrayTek Banner - Please uncheck this box and the following screen will not be shown for the unreachable web page. The default setting is Enabled.

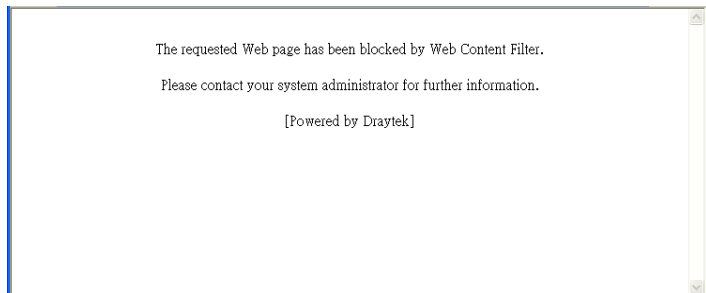

Strict Security Checking - All the packets, while transmitting through Vigor router, will be filtered by firewall settings configured by Vigor router. When the resource is inadequate, the packets will be blocked if Strict Security Checking is enabled. If Strict Security Checking is not enabled, then the packets will pass through the router.

3. When you finish the configuration, please click OK to save and exit this page.

V-1-3 DoS Defense

As a sub-functionality of IP Filter/Firewall, there are 15 types of detect/ defense function in the DoS Defense setup. The DoS Defense functionality is disabled for default.

V-1-3-1 DoS Defense

Click Firewall and click DoS Defense to open the setup page.

Firewall >> Defense Setup

DoS Defense
Spoofing Defense

DoS defense

Enable DoS Defense Select All

<input type="checkbox"/> Enable SYN flood defense	Threshold	<input type="text" value="2000"/>	packets / sec
	Timeout	<input type="text" value="10"/>	sec
<input type="checkbox"/> Enable UDP flood defense	Threshold	<input type="text" value="2000"/>	packets / sec
	Timeout	<input type="text" value="10"/>	sec
<input type="checkbox"/> Enable ICMP flood defense	Threshold	<input type="text" value="250"/>	packets / sec
	Timeout	<input type="text" value="10"/>	sec
<input type="checkbox"/> Enable Port Scan detection	Threshold	<input type="text" value="2000"/>	packets / sec
<input type="checkbox"/> Block IP options	<input type="checkbox"/> Block TCP flag scan		
<input type="checkbox"/> Block Land	<input type="checkbox"/> Block Tear Drop		
<input type="checkbox"/> Block Smurf	<input type="checkbox"/> Block Ping of Death		
<input type="checkbox"/> Block trace route	<input type="checkbox"/> Block ICMP fragment		
<input type="checkbox"/> Block SYN fragment	<input type="checkbox"/> Block Unassigned Numbers		
<input type="checkbox"/> Block Fraggle Attack			

OK
Clear All
Cancel

Available settings are explained as follows:

Item	Description
Enable Dos Defense	Check the box to activate the DoS Defense Functionality. Select All - Click this button to select all the items listed below. White/Black List Option - Set white/black list of IPv4/IPv6 address.
Enable SYN flood defense	Check the box to activate the SYN flood defense function. Once detecting the Threshold of the TCP SYN packets from the Internet has exceeded the defined value, the Vigor router will start to randomly discard the subsequent TCP SYN packets for a period defined in Timeout. The goal for this is prevent the TCP SYN packets' attempt to exhaust the limited-resource of Vigor router. By default, the threshold and timeout values are set to 2000 packets per second and 10 seconds, respectively. That means, when 2000 packets per second received, they will be regarded as "attack event" and the session will be paused for 10 seconds.

Enable UDP flood defense	<p>Check the box to activate the UDP flood defense function. Once detecting the Threshold of the UDP packets from the Internet has exceeded the defined value, the Vigor router will start to randomly discard the subsequent UDP packets for a period defined in Timeout.</p> <p>The default setting for threshold and timeout are 2000 packets per second and 10 seconds, respectively. That means, when 2000 packets per second received, they will be regarded as "attack event" and the session will be paused for 10 seconds.</p>
Enable ICMP flood defense	<p>Check the box to activate the ICMP flood defense function. Similar to the UDP flood defense function, once if the Threshold of ICMP packets from Internet has exceeded the defined value, the router will discard the ICMP echo requests coming from the Internet.</p> <p>The default setting for threshold and timeout are 250 packets per second and 10 seconds, respectively. That means, when 250 packets per second received, they will be regarded as "attack event" and the session will be paused for 10 seconds.</p>
Enable Port Scan detection	<p>Port Scan attacks the Vigor router by sending lots of packets to many ports in an attempt to find ignorant services would respond. Check the box to activate the Port Scan detection. Whenever detecting this malicious exploration behavior by monitoring the port-scanning Threshold rate, the Vigor router will send out a warning.</p> <p>By default, the Vigor router sets the threshold as 2000 packets per second. That means, when 2000 packets per second received, they will be regarded as "attack event".</p>
Block IP options	<p>Check the box to activate the Block IP options function. The Vigor router will ignore any IP packets with IP option field in the datagram header. The reason for limitation is IP option appears to be a vulnerability of the security for the LAN because it will carry significant information, such as security, TCC (closed user group) parameters, a series of Internet addresses, routing messages...etc. An eavesdropper outside might learn the details of your private networks.</p>
Block Land	<p>Check the box to enforce the Vigor router to defense the Land attacks. The Land attack combines the SYN attack technology with IP spoofing. A Land attack occurs when an attacker sends spoofed SYN packets with the identical source and destination addresses, as well as the port number to victims.</p>
Block Smurf	<p>Check the box to activate the Block Smurf function. The Vigor router will ignore any broadcasting ICMP echo request.</p>
Block trace route	<p>Check the box to enforce the Vigor router not to forward any trace route packets.</p>
Block SYN fragment	<p>Check the box to activate the Block SYN fragment function. The Vigor router will drop any packets having SYN flag and more fragment bit set.</p>
Block Fraggle Attack	<p>Check the box to activate the Block fraggle Attack function. Any broadcast UDP packets received from the Internet is blocked.</p>

	<p>Activating the DoS/DDoS defense functionality might block some legal packets. For example, when you activate the fraggle attack defense, all broadcast UDP packets coming from the Internet are blocked. Therefore, the RIP packets from the Internet might be dropped.</p>		
Block TCP flag scan	<p>Check the box to activate the Block TCP flag scan function. Any TCP packet with anomaly flag setting is dropped. Those scanning activities include <i>no flag scan</i>, <i>FIN without ACK scan</i>, <i>SYN FINscan</i>, <i>Xmas scan</i> and <i>full Xmas scan</i>.</p>		
Block Tear Drop	<p>Check the box to activate the Block Tear Drop function. Many machines may crash when receiving ICMP datagrams (packets) that exceed the maximum length. To avoid this type of attack, the Vigor router is designed to be capable of discarding any fragmented ICMP packets with a length greater than 1024 octets.</p>		
Block Ping of Death	<p>Check the box to activate the Block Ping of Death function. This attack involves the perpetrator sending overlapping packets to the target hosts so that those target hosts will hang once they re-construct the packets. The Vigor routers will block any packets realizing this attacking activity.</p>		
Block ICMP Fragment	<p>Check the box to activate the Block ICMP fragment function. Any ICMP packets with more fragment bit set are dropped.</p>		
Block Unassigned Numbers	<p>Check the box to activate the Block Unknown Protocol function. Individual IP packet has a protocol field in the datagram header to indicate the protocol type running over the upper layer. However, the protocol types greater than 100 are reserved and undefined at this time. Therefore, the router should have ability to detect and reject this kind of packets.</p>		
Warning Messages	<p>We provide Syslog function for user to retrieve message from Vigor router. The user, as a Syslog Server, shall receive the report sending from Vigor router which is a Syslog Client.</p> <p>All the warning messages related to DoS Defense will be sent to user and user can review it through Syslog daemon. Look for the keyword DoS in the message, followed by a name to indicate what kind of attacks is detected.</p> <p>System Maintenance >> SysLog / Mail Alert Setup</p> <div style="border: 1px solid black; padding: 5px;"> <p>SysLog / Mail Alert Setup</p> <table border="1" style="width: 100%; border-collapse: collapse;"> <tr> <td style="width: 50%; vertical-align: top;"> <p>SysLog Access Setup</p> <p><input checked="" type="checkbox"/> Enable</p> <p>Syslog Save to:</p> <p><input checked="" type="checkbox"/> Syslog Server</p> <p><input type="checkbox"/> USB Disk</p> <p>Router Name <input type="text" value="DrayTek"/></p> <p>Server IP/Hostname <input type="text"/></p> <p>Destination Port <input type="text" value="514"/></p> <p>Mail Syslog <input type="checkbox"/> Enable</p> <p>Enable syslog message:</p> <p><input checked="" type="checkbox"/> Firewall Log</p> <p><input checked="" type="checkbox"/> VPN Log</p> <p><input checked="" type="checkbox"/> User Access Log</p> <p><input checked="" type="checkbox"/> Call Log</p> <p><input checked="" type="checkbox"/> WAN Log</p> <p><input checked="" type="checkbox"/> Router/DSL information</p> <p><input checked="" type="checkbox"/> WLAN Log</p> </td> <td style="width: 50%; vertical-align: top;"> <p>Mail Alert Setup</p> <p><input type="checkbox"/> Enable <input type="button" value="Send a test e-mail"/></p> <p>SMTP Server <input type="text"/></p> <p>SMTP Port <input type="text" value="25"/></p> <p>Mail To <input type="text"/></p> <p>Return-Path <input type="text"/></p> <p><input type="checkbox"/> Use SSL</p> <p><input type="checkbox"/> Authentication</p> <p>Username <input type="text"/></p> <p>Password <input type="text"/></p> <p>Enable E-Mail Alert:</p> <p><input checked="" type="checkbox"/> DoS Attack</p> <p><input checked="" type="checkbox"/> APPE</p> <p><input checked="" type="checkbox"/> VPN LOG</p> <p><input type="checkbox"/> APPE Signature</p> <p><input type="checkbox"/> Debug Log</p> </td> </tr> </table> <p>Note:</p> <ol style="list-style-type: none"> Mail Syslog cannot be activated unless USB Disk is ticked for "Syslog Save to". Mail Syslog feature sends a Syslog file when its size reaches 1M Bytes. We only support secured SMTP connection on port 465. <p style="text-align: right;"><input type="button" value="OK"/> <input type="button" value="Clear"/></p> </div>	<p>SysLog Access Setup</p> <p><input checked="" type="checkbox"/> Enable</p> <p>Syslog Save to:</p> <p><input checked="" type="checkbox"/> Syslog Server</p> <p><input type="checkbox"/> USB Disk</p> <p>Router Name <input type="text" value="DrayTek"/></p> <p>Server IP/Hostname <input type="text"/></p> <p>Destination Port <input type="text" value="514"/></p> <p>Mail Syslog <input type="checkbox"/> Enable</p> <p>Enable syslog message:</p> <p><input checked="" type="checkbox"/> Firewall Log</p> <p><input checked="" type="checkbox"/> VPN Log</p> <p><input checked="" type="checkbox"/> User Access Log</p> <p><input checked="" type="checkbox"/> Call Log</p> <p><input checked="" type="checkbox"/> WAN Log</p> <p><input checked="" type="checkbox"/> Router/DSL information</p> <p><input checked="" type="checkbox"/> WLAN Log</p>	<p>Mail Alert Setup</p> <p><input type="checkbox"/> Enable <input type="button" value="Send a test e-mail"/></p> <p>SMTP Server <input type="text"/></p> <p>SMTP Port <input type="text" value="25"/></p> <p>Mail To <input type="text"/></p> <p>Return-Path <input type="text"/></p> <p><input type="checkbox"/> Use SSL</p> <p><input type="checkbox"/> Authentication</p> <p>Username <input type="text"/></p> <p>Password <input type="text"/></p> <p>Enable E-Mail Alert:</p> <p><input checked="" type="checkbox"/> DoS Attack</p> <p><input checked="" type="checkbox"/> APPE</p> <p><input checked="" type="checkbox"/> VPN LOG</p> <p><input type="checkbox"/> APPE Signature</p> <p><input type="checkbox"/> Debug Log</p>
<p>SysLog Access Setup</p> <p><input checked="" type="checkbox"/> Enable</p> <p>Syslog Save to:</p> <p><input checked="" type="checkbox"/> Syslog Server</p> <p><input type="checkbox"/> USB Disk</p> <p>Router Name <input type="text" value="DrayTek"/></p> <p>Server IP/Hostname <input type="text"/></p> <p>Destination Port <input type="text" value="514"/></p> <p>Mail Syslog <input type="checkbox"/> Enable</p> <p>Enable syslog message:</p> <p><input checked="" type="checkbox"/> Firewall Log</p> <p><input checked="" type="checkbox"/> VPN Log</p> <p><input checked="" type="checkbox"/> User Access Log</p> <p><input checked="" type="checkbox"/> Call Log</p> <p><input checked="" type="checkbox"/> WAN Log</p> <p><input checked="" type="checkbox"/> Router/DSL information</p> <p><input checked="" type="checkbox"/> WLAN Log</p>	<p>Mail Alert Setup</p> <p><input type="checkbox"/> Enable <input type="button" value="Send a test e-mail"/></p> <p>SMTP Server <input type="text"/></p> <p>SMTP Port <input type="text" value="25"/></p> <p>Mail To <input type="text"/></p> <p>Return-Path <input type="text"/></p> <p><input type="checkbox"/> Use SSL</p> <p><input type="checkbox"/> Authentication</p> <p>Username <input type="text"/></p> <p>Password <input type="text"/></p> <p>Enable E-Mail Alert:</p> <p><input checked="" type="checkbox"/> DoS Attack</p> <p><input checked="" type="checkbox"/> APPE</p> <p><input checked="" type="checkbox"/> VPN LOG</p> <p><input type="checkbox"/> APPE Signature</p> <p><input type="checkbox"/> Debug Log</p>		

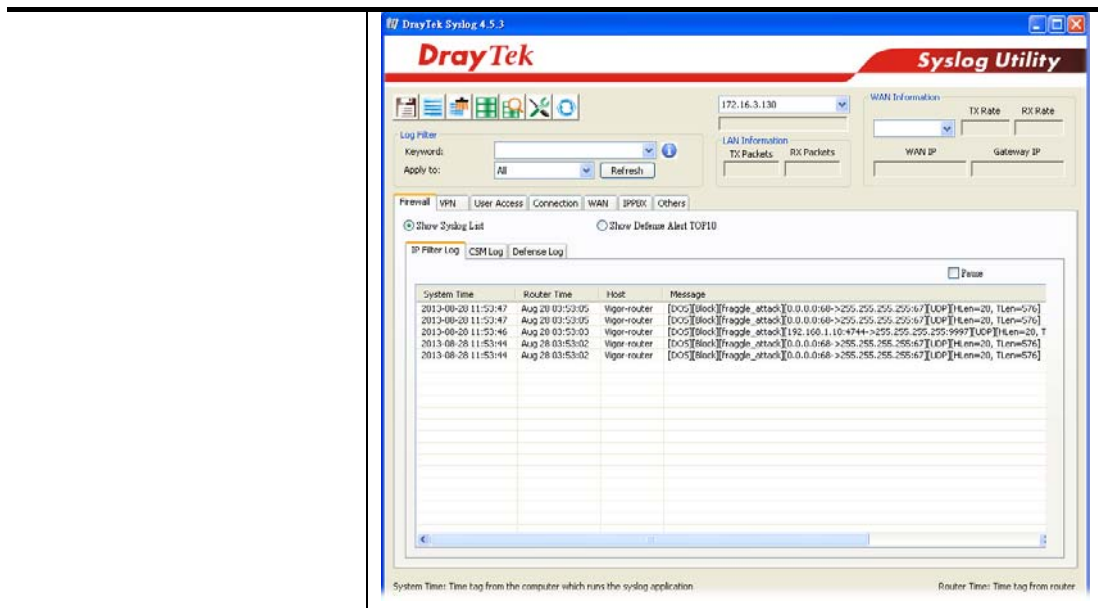

After finishing all the settings here, please click OK to save the configuration.

V-1-3-2 Spoofing Defense

Click the Spoofing Defense tab to open the setup page.

Firewall >> Defense Setup

DoS Defense Spoofing Defense

ARP Spoofing Defense

- Block ARP replies with inconsistent source MAC addresses.
- Block ARP replies with inconsistent destination MAC addresses.
- Decline VRRP MAC into ARP table.

IP Spoofing Defense

- Block IP packet from WAN with inconsistent source IP addresses.
- Block IP packet from LAN with inconsistent source IP addresses.

OK Cancel

Application Notes

A-1 How to Configure Certain Computers Accessing to Internet

We can specify certain computers (e.g., 192.168.1.10 ~ 192.168.1.20) accessing to Internet through Vigor router. Others (e.g., 192.168.1.31 and 192.168.1.32) outside the range can get the source from LAN only.

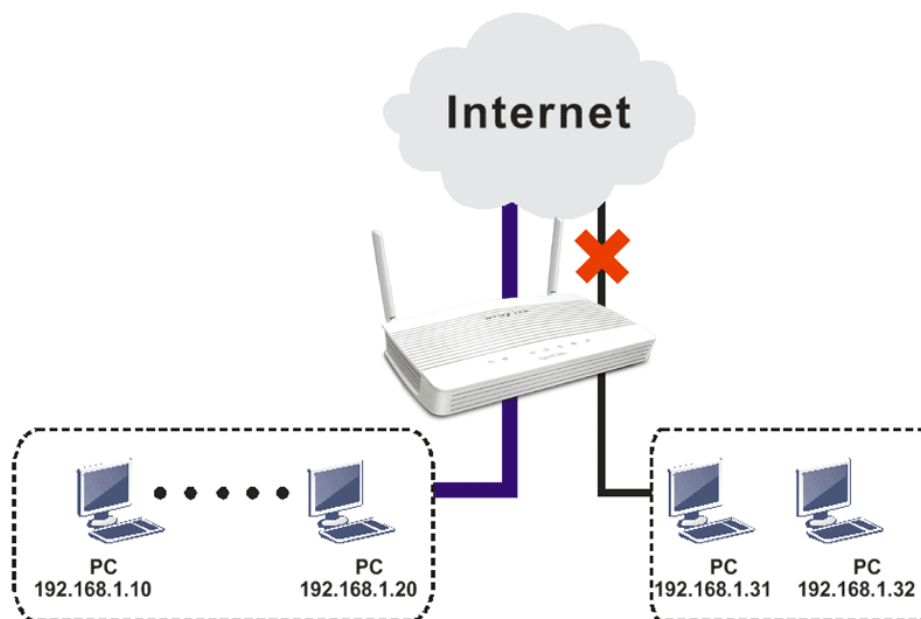

The way we can use is to set two rules under Firewall. For Rule 1 of Set 2 under Firewall>>Filter Setup is used as the default setting, we have to create a new rule starting from Filter Rule 2 of Set 2.

1. Access into the web user interface of Vigor router.
2. Open Firewall>>Filter Setup. Click the Set 2 link, choose Advance Mode and choose the Filter Rule 2 button.

Firewall >> Filter Setup

Filter Setup		Set to Factory Default	
Set	Comments	Set	Comments
1.	Default Call Filter	7.	
2.	Default Data Filter	8.	
		9.	
		10.	
		11.	
		12.	

3. Check the box of Check to enable the Filter Rule. Enter the comments (e.g., block_all). Choose Block If No Further Match for the Filter setting. Then, click OK.

Filter Set 2 Rule 2

Check to enable the Filter Rule

Comments:

Index(1-15) in **Schedule** Setup: , , ,

Clear sessions when schedule ON: Enable

Direction: LAN/RT/VPN -> WAN

Source IP:

Destination IP:

Service Type:

Fragments:

Application **Action/Profile** **Syslog**

Filter:

Branch to Other Filter Set:

Sessions Control:



Info

In default, the router will check the packets starting with Set 2, Filter Rule 2 to Filter Rule 7. If Block If No Further Match for is selected for Filter, the firewall of the router would check the packets with the rules starting from Rule 3 to Rule 7. The packets not matching with the rules will be processed according to Rule 2.

4. Next, set another rule. Just open Firewall>>Filter Setup. Click the Set 2 link and choose the Filter Rule 3 button.
5. Check the box of Check to enable the Filter Rule. Enter the comments (e.g., open_ip). Click the Edit button for Source IP.

Filter Set 2 Rule 3

Check to enable the Filter Rule

Comments:

Index(1-15) in **Schedule** Setup: , , ,

Clear sessions when schedule ON: Enable

Direction: LAN/RT/VPN -> WAN

Source IP:

Destination IP:

Service Type:

Fragments:

Application **Action/Profile** **Syslog**

Filter:

Branch to Other Filter Set:

- A dialog box will be popped up. Choose **Range Address** as **Address Type** by using the drop down list. Type 192.168.1.10 in the field of **Start IP**, and type 192.168.1.20 in the field of **End IP**. Then, click **OK** to save the settings. The computers within the range can access into the Internet.

IP Address Edit

Address Type	Range Address
Start IP Address	192.168.1.10
End IP Address	192.168.1.20
Subnet Mask	0.0.0.0
Invert Selection	<input type="checkbox"/>
IP Group	None
or IP Object	None
or IP Object	None
or IP Object	None
IPv6 Group	None
or IPv6 Object	None
or IPv6 Object	None
or IPv6 Object	None

OK Close

- Now, check the content of **Source IP** is correct or not. The action for **Filter** shall be set with **Pass Immediately**. Then, click **OK** to save the settings.

Firewall >> Edit Filter Set >> Edit Filter Rule

Filter Set 2 Rule 3

<input checked="" type="checkbox"/> Check to enable the Filter Rule	
Comments:	open_ip
Index(1-15) in Schedule Setup:	
Clear sessions when schedule ON:	<input type="checkbox"/> Enable
Direction:	LAN/RT/VPN -> WAN
Source IP:	192.168.1.10~192.168.1.20
Destination IP:	Any
Service Type:	Any
Fragments:	Don't Care
Application	Action/Profile
Filter:	Pass Immediately
Branch to Other Filter Set:	None
	Syslog <input type="checkbox"/>

8. Both filter rules have been created. Click OK.

Firewall >> Filter Setup >> Edit Filter Set

Filter Set 2

Comments :

Filter Rule	Active	Comments	Move Up	Move Down
<input type="button" value="1"/>	<input checked="" type="checkbox"/>	xNetBios -> DNS		<u>Down</u>
<input type="button" value="2"/>	<input checked="" type="checkbox"/>	block_all	<u>UP</u>	<u>Down</u>
<input type="button" value="3"/>	<input checked="" type="checkbox"/>	open_ip	<u>UP</u>	<u>Down</u>
<input type="button" value="4"/>	<input type="checkbox"/>		<u>UP</u>	<u>Down</u>
<input type="button" value="5"/>	<input type="checkbox"/>		<u>UP</u>	<u>Down</u>
<input type="button" value="6"/>	<input type="checkbox"/>		<u>UP</u>	<u>Down</u>
<input type="button" value="7"/>	<input type="checkbox"/>		<u>UP</u>	

Next Filter Set

Now, all the settings are configured well. Only the computers with the IP addresses within 192.168.1.10 ~ 192.168.1.20 can access to Internet.

V-2 Central Security Management (CSM)

CSM is an abbreviation of **Central Security Management** which is used to control IM/P2P usage, filter the web content and URL content to reach a goal of security management.

APP Enforcement Filter

As the popularity of all kinds of instant messenger application arises, communication cannot become much easier. Nevertheless, while some industry may leverage this as a great tool to connect with their customers, some industry may take reserved attitude in order to reduce employee misuse during office hour or prevent unknown security leak. It is similar situation for corporation towards peer-to-peer applications since file-sharing can be convenient but insecure at the same time. To address these needs, we provide CSM functionality.

URL Content Filter

To provide an appropriate cyberspace to users, Vigor router equips with **URL Content Filter** not only to limit illegal traffic from/to the inappropriate web sites but also prohibit other web feature where malicious code may conceal.

Once a user Enter or click on an URL with objectionable keywords, URL keyword blocking facility will decline the HTTP request to that web page thus can limit user's access to the website. You may imagine **URL Content Filter** as a well-trained convenience-store clerk who won't sell adult magazines to teenagers. At office, **URL Content Filter** can also provide a job-related only environment hence to increase the employee work efficiency. How can URL Content Filter work better than traditional firewall in the field of filtering? Because it checks the URL strings or some of HTTP data hiding in the payload of TCP packets while legacy firewall inspects packets based on the fields of TCP/IP headers only.

On the other hand, Vigor router can prevent user from accidentally downloading malicious codes from web pages. It's very common that malicious codes conceal in the executable objects, such as ActiveX, Java Applet, compressed files, and other executable files. Once downloading these types of files from websites, you may risk bringing threat to your system. For example, an ActiveX control object is usually used for providing interactive web feature. If malicious code hides inside, it may occupy user's system.

Web Content Filter

We all know that the content on the Internet just like other types of media may be inappropriate sometimes. As a responsible parent or employer, you should protect those in your trust against the hazards. With Web filtering service of the Vigor router, you can protect your business from common primary threats, such as productivity, legal liability, network and security threats. For parents, you can protect your children from viewing adult websites or chat rooms.

Once you have activated your Web Filtering service in Vigor router and chosen the categories of website you wish to restrict, each URL address requested (e.g. www.bbc.co.uk) will be checked against our server database. This database is updated as frequent as daily by a global team of Internet researchers. The server will look up the URL and return a category to your router. Your Vigor router will then decide whether to allow access to this site according to the categories you have selected. Please note that this action will not introduce any delay in your Web surfing because each of multiple load balanced database servers can handle millions of requests for categorization.



Info

The priority of URL Content Filter is higher than Web Content Filter.

Web User Interface

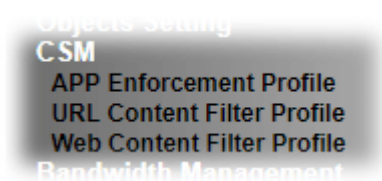

V-2-1 APP Enforcement Profile

You can define policy profiles for IM (Instant Messenger)/P2P (Peer to Peer)/Protocol/Misc application. This page allows you to set 32 profiles for different requirements. The APP Enforcement Profile will be applied in **Default Rule of Firewall>>General Setup** for filtering.

CSM >> APP Enforcement Profile

APP Enforcement Profile Table: [Set to Factory Default](#)

Profile	Name	Profile	Name
1.		17.	
2.		18.	
3.		19.	
4.		20.	
5.		21.	
6.		22.	
7.		23.	
8.		24.	
9.		25.	
10.		26.	
11.		27.	
12.		28.	
13.		29.	
14.		30.	
15.		31.	
16.		32.	

Available settings are explained as follows:

Item	Description
Set to Factory Default	Clear all profiles.
Profile	Display the number of the profile which allows you to click to set different policy.
Name	Display the name of the APP Enforcement Profile.

Click the number under Index column for settings in detail.

Profile Index : 1

Profile Name:

Category	Application		
Instant Message	<input type="checkbox"/> AIM +	<input type="checkbox"/> AIM Login	<input type="checkbox"/> AliWW
<input type="button" value="Select All"/>	<input type="checkbox"/> Ares	<input type="checkbox"/> BaiduHi	<input type="checkbox"/> Facebook
<input type="button" value="Clear All"/>	<input type="checkbox"/> Fetion	<input type="checkbox"/> GaduGadu Protocol	<input type="checkbox"/> Google Hangouts
	<input type="checkbox"/> ICQ	<input type="checkbox"/> iMessage	<input type="checkbox"/> iSpQ
	<input type="checkbox"/> KC	<input type="checkbox"/> LINE	<input type="checkbox"/> Paltalk
	<input type="checkbox"/> PocoCall	<input type="checkbox"/> Qnext	<input type="checkbox"/> Tencent QQ
	<input type="checkbox"/> UC	<input type="checkbox"/> WebIM URLs	<input type="checkbox"/> WhatsApp
	<input type="checkbox"/> Yahoo! Messenger +		
VoIP	<input type="checkbox"/> RC Voice	<input type="checkbox"/> Skype	<input type="checkbox"/> TeamSpeak
<input type="button" value="Select All"/>	<input type="checkbox"/> TelTel		
<input type="button" value="Clear All"/>			
P2P	<input type="checkbox"/> BitTorrent	<input type="checkbox"/> eDonkey	<input type="checkbox"/> FastTrack
<input type="button" value="Select All"/>	<input type="checkbox"/> Gnutella	<input type="checkbox"/> OpenFT	<input type="checkbox"/> OpenNap
<input type="button" value="Clear All"/>	<input type="checkbox"/> SoulSeek	<input type="checkbox"/> Ares	<input type="checkbox"/> ClubBox
	<input type="checkbox"/> Huntmine	<input type="checkbox"/> Kuwo	<input type="checkbox"/> Pando
	<input type="checkbox"/> Spotify	<input type="checkbox"/> Vagaa	<input type="checkbox"/> Xunlei(Thunder)

Available settings are explained as follows:

Item	Description
Profile Name	Type a name for the CSM profile. The maximum length of the name you can set is 15 characters.
Select All	Click it to choose all of the items in this page.
Clear All	Uncheck all the selected boxes.
Enable	Check the box to select the APP to be blocked by Vigor router.

The profiles configured here can be applied in the **Firewall>>General Setup** and **Firewall>>Filter Setup** pages as the standard for the host(s) to follow.

V-2-2 URL Content Filter Profile

To provide an appropriate cyberspace to users, Vigor router equips with **URL Content Filter** not only to limit illegal traffic from/to the inappropriate web sites but also prohibit other web feature where malicious code may conceal.

Once a user Enter or click on an URL with objectionable keywords, URL keyword blocking facility will decline the HTTP request to that web page thus can limit user's access to the website. You may imagine **URL Content Filter** as a well-trained convenience-store clerk who won't sell adult magazines to teenagers. At office, **URL Content Filter** can also provide a job-related only environment hence to increase the employee work efficiency. How can URL Content Filter work better than traditional firewall in the field of filtering? Because it checks the URL strings or some of HTTP data hiding in the payload of TCP packets while legacy firewall inspects packets based on the fields of TCP/IP headers only.

On the other hand, Vigor router can prevent user from accidentally downloading malicious codes from web pages. It's very common that malicious codes conceal in the executable objects, such as ActiveX, Java Applet, compressed files, and other executable files. Once downloading these types of files from websites, you may risk bringing threat to your system. For example, an ActiveX control object is usually used for providing interactive web feature. If malicious code hides inside, it may occupy user's system.

For example, if you add key words such as "sex", Vigor router will limit web access to web sites or web pages such as "www.sex.com", "www.backdoor.net/images/sex/p_386.html". Or you may simply specify the full or partial URL such as "www.sex.com" or "sex.com".

Also the Vigor router will discard any request that tries to retrieve the malicious code.

Click CSM and click **URL Content Filter Profile** to open the profile setting page.

CSM >> URL Content Filter Profile



URL Content Filter Profile Table:

| [Set to Factory Default](#) |

Profile	Name	Profile	Name
1.		5.	
2.		6.	
3.		7.	
4.		8.	

Note:

To make URL Content Filter profile effective, please go to [Firewall >> Filter Setup](#) page to create a firewall rule and select the desired profile.

Administration Message (Max 255 characters)

Default Message

```
<body><center><br><p>The requested Web page has been blocked by URL Content Filter.<p>Please contact your system administrator for further information.</center></body>
```

OK

Each item is explained as follows:

Item	Description
Set to Factory Default	Clear all profiles.
Profile	Display the number of the profile which allows you to click to set different policy.
Name	Display the name of the URL Content Filter Profile.

Administration Message	You can Enter the message manually for your necessity. Default Message - You can Enter the message manually for your necessity or click this button to get the default message which will be displayed on the field of Administration Message .
-------------------------------	--

You can set eight profiles as URL content filter. Simply click the index number under Profile to open the following web page.

CSM >> URL Content Filter Profile

Profile Index: 1

Profile Name:

Priority: **Log:**

1.URL Access Control

Enable URL Access Control Prevent web access from IP address

Action: Group/Object Selections

Exception List

2.Web Feature

Enable Web Feature Restriction

Action: **File Extension Profile:** Cookie Proxy Upload

Available settings are explained as follows:

Item	Description
Profile Name	Type a name for the CSM profile. The maximum length of the name you can set is 15 characters.
Priority	<p>It determines the action that this router will apply.</p> <p>Both: Pass - The router will let all the packages that match with the conditions specified in URL Access Control and Web Feature below passing through. When you choose this setting, both configuration set in this page for URL Access Control and Web Feature will be inactive.</p> <p>Both:Block -The router will block all the packages that match with the conditions specified in URL Access Control and Web Feature below. When you choose this setting, both configuration set in this page for URL Access Control and Web Feature will be inactive.</p> <p>Either: URL Access Control First - When all the packages matching with the conditions specified in URL Access Control and Web Feature below, such function can determine the priority for the actions executed. For this one, the router will process the packages with the conditions set below for URL first, then Web feature second.</p> <p>Either: Web Feature First -When all the packages matching with the conditions specified in URL Access Control and Web Feature below, such function can determine the priority for the actions executed. For this one, the router will process the packages with the conditions set below for web feature first, then URL second.</p>

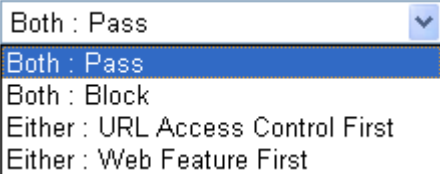
	
Log	<p>Pass - Only the log about Pass will be recorded in Syslog. Block - Only the log about Block will be recorded in Syslog. All - All the actions (Pass and Block) will be recorded in Syslog.</p>
URL Access Control	<p>Enable URL Access Control - Check the box to activate URL Access Control. Note that the priority for URL Access Control is higher than Restrict Web Feature. If the web content match the setting set in URL Access Control, the router will execute the action specified in this field and ignore the action specified under Restrict Web Feature.</p> <p>Prevent web access from IP address - Check the box to deny any web surfing activity using IP address, such as http://202.6.3.2. The reason for this is to prevent someone dodges the URL Access Control. You must clear your browser cache first so that the URL content filtering facility operates properly on a web page that you visited before.</p> <p>Action - This setting is available only when Either : URL Access Control First or Either : Web Feature First is selected.</p> <ul style="list-style-type: none"> ● Pass - Allow accessing into the corresponding webpage with the keywords listed on the box below. ● Block - Restrict accessing into the corresponding webpage with the keywords listed on the box below. If the web pages do not match with the keyword set here, it will be processed with reverse action. <p>Exception List - Specify the object profile(s) as the exception list which will be processed in an opposite manner to the action selected above.</p> <p>Group/Object Selections - The Vigor router provides several frames for users to define keywords and each frame supports multiple keywords. The keyword could be a noun, a partial noun, or a complete URL string. Multiple keywords within a frame are separated by space, comma, or semicolon. In addition, the maximal length of each frame is 32-character long. After specifying keywords, the Vigor router will decline the connection request to the website whose URL string matched to any user-defined keyword. It should be noticed that the more simplified the blocking keyword list is, the more efficiently the Vigor router performs.</p>

Object/Group Edit	
<u>Keyword Object</u>	None ▾
or Keyword Object	None ▾
or Keyword Object	None ▾
or Keyword Object	None ▾
or Keyword Object	None ▾
or Keyword Object	None ▾
or Keyword Object	None ▾
or Keyword Object	None ▾
or <u>Keyword Group</u>	None ▾
or Keyword Group	None ▾
or Keyword Group	None ▾
or Keyword Group	None ▾
or Keyword Group	None ▾
or Keyword Group	None ▾
or Keyword Group	None ▾
or Keyword Group	None ▾

Web Feature

Enable Web Feature Restriction- Check this box to make the keyword being blocked or passed.

Action - This setting is available only when **Either: URL Access Control First** or **Either: Web Feature First** is selected.

Pass - Allow accessing into the corresponding webpage with the keywords listed on the box below.

Block - Restrict accessing into the corresponding webpage with the keywords listed on the box below.

If the web pages do not match with the specified feature set here, it will be processed with reverse action.

File Extension Profile - Choose one of the profiles that you configured in **Object Setting>> File Extension Objects** previously for passing or blocking the file downloading.

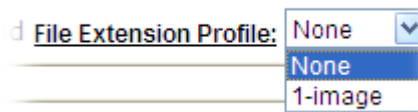

Cookie - Check the box to filter out the cookie transmission from inside to outside world to protect the local user's privacy.

Proxy - Check the box to reject any proxy transmission. To control efficiently the limited-bandwidth usage, it will be of great value to provide the blocking mechanism that filters out the multimedia files downloading from web pages.

Upload - Check the box to block the file upload by way of web page.

After finishing all the settings, please click **OK** to save the configuration.

V-2-3 Web Content Filter Profile

There are three ways to activate WCF on vigor router, using **Service Activation Wizard**, by means of **CSM>>Web Content Filter Profile** or via **System Maintenance>>Activation**.

Service Activation Wizard allows you to use trial version of WCF directly without accessing into the server (**MyVigor**) located on <http://myvigor.draytek.com>.

However, if you use the **Web Content Filter Profile** page to activate WCF feature, it is necessary for you to access into the server (**MyVigor**) located on <http://myvigor.draytek.com>. Therefore, you need to register an account on <http://myvigor.draytek.com> for using corresponding service. Please refer to section of creating MyVigor account.

WCF adopts the mechanism developed and offered by certain service provider (e.g., DrayTek). No matter activating WCF feature or getting a new license for web content filter, you have to click **Activate** to satisfy your request. Be aware that service provider matching with Vigor router currently offers a period of time for trial version for users to experiment. If you want to purchase a formal edition, simply contact with the channel partner or your dealer.

Click **CSM** and click **Web Content Filter Profile** to open the profile setting page. The default setting for Setup Query Server /Setup Test Server is **auto-selected**. You can choose another server for your necessity by clicking **Find more** to open <http://myvigor.draytek.com> for searching another qualified and suitable one.



Info 1

Web Content Filter (WCF) is not a built-in service of Vigor router but a service powered by Commtouch. If you want to use such service (trial or formal edition), you have to perform the procedure of activation first. For the service of formal edition, please contact with your dealer/distributor for detailed information.

Info 2

Commtouch is merged by Cyren, and GlobalView services will be continued to deliver powerful cloud-based information security solutions! Refer to: <http://www.prnewswire.com/news-releases/commtouch-is-now-cyren-239025151.html>



Web-Filter License

[Activate](#)

[Status:Not Activated]

Setup Query Server	auto-selected	Find more
Setup Test Server	auto-selected	Find more

Web Content Filter Profile Table: Cache : **L1 + L2 Cache** | [Set to Factory Default](#) |

Profile	Name	Profile	Name
1.	Default	5.	
2.		6.	
3.		7.	
4.		8.	

Note:

To make Web Content Filter profile effective, please go to [Firewall >> Filter Setup](#) page to create a firewall rule and select the desired profile.

Administration Message (Max 255 characters)

[Default Message](#)

```
<body><center><br><br><br><p>The requested Web page <br> from %SIP% <br>to %URL% <br>that is categorized with %CL% <br>has been blocked by %RNAME% Web Content Filter.<p>Please contact your system administrator for further information.</center></body>
```

Legend:

%SIP% - Source IP , %DIP% - Destination IP , %URL% - URL
 %CL% - Category , %RNAME% - Router Name

OK

Available settings are explained as follows:

Item	Description
Activate	Click it to access into MyVigor for activating WCF service.
Setup Query Server	It is recommended for you to use the default setting, auto-selected. You need to specify a server for categorize searching when you type URL in browser based on the web content filter profile. Find more - Click it to open http://myvigor.draytek.com for searching another qualified and suitable server.
Setup Test Server	It is recommended for you to use the default setting, auto-selected. Find more - Click it to open http://myvigor.draytek.com for searching another qualified and suitable server.
Cache	None - the router will check the URL that the user wants to access via WCF precisely, however, the processing rate is normal. Such item can provide the most accurate URL matching. L1 - the router will check the URL that the user wants to access via WCF. If the URL has been accessed previously, it will be stored in the router to be accessed quickly if required. Such item can provide accurate URL matching with faster rate. L2 - the router will check the URL that the user wants to access via WCF. If the data has been accessed previously, the IP addresses of source and destination IDs will be memorized for a short time (about 1 second) in the router. When the

	<p>user tries to access the same destination ID, the router will check it by comparing the record stored. If it matches, the page will be retrieved quickly. Such item can provide URL matching with the fastest rate.</p> <p>L1+L2 Cache - the router will check the URL with fast processing rate combining the feature of L1 and L2.</p>
Set to Factory Default	Click this link to retrieve the factory settings.
Administration Message	You can Enter the message manually for your necessity or click Default Message button to get the default text displayed on the field of Administration Message .

Eight profiles are provided here as Web content filters. Simply click the index number under Profile to open the following web page. The items listed in Categories will be changed according to the different service providers. If you have and activate another web content filter license, the items will be changed simultaneously. All of the configuration made for web content filter will be deleted automatically. Therefore, please backup your data before you change the web content filter license.

CSM >> Web Content Filter Profile

Profile Index: 1

Profile Name:

Log:

Black/White List

Enable

Action:

URL keywords:

Action:

<p>Groups</p> <p>Child Protection</p> <p><input type="button" value="Select All"/></p> <p><input type="button" value="Clear All"/></p> <p>Leisure</p> <p><input type="button" value="Select All"/></p> <p><input type="button" value="Clear All"/></p> <p>Business</p> <p><input type="button" value="Select All"/></p>	<p>Categories</p> <p><input checked="" type="checkbox"/> Alcohol & Tobacco</p> <p><input checked="" type="checkbox"/> Hate & Intolerance</p> <p><input checked="" type="checkbox"/> Porn & Sexually</p> <p><input checked="" type="checkbox"/> School Cheating</p> <p><input checked="" type="checkbox"/> Child Abuse Images</p> <p><input type="checkbox"/> Entertainment</p> <p><input type="checkbox"/> Travel</p>	<p><input checked="" type="checkbox"/> Criminal Activity</p> <p><input checked="" type="checkbox"/> Illegal Drug</p> <p><input checked="" type="checkbox"/> Violence</p> <p><input checked="" type="checkbox"/> Sex Education</p> <p><input type="checkbox"/> Games</p> <p><input type="checkbox"/> Leisure & Recreation</p>	<p><input checked="" type="checkbox"/> Gambling</p> <p><input checked="" type="checkbox"/> Nudity</p> <p><input checked="" type="checkbox"/> Weapons</p> <p><input checked="" type="checkbox"/> Tasteless</p> <p><input type="checkbox"/> Sports</p> <p><input type="checkbox"/> Fashion & Beauty</p>
--	--	--	---

Available settings are explained as follows:

Item	Description
Profile Name	Type a name for the CSM profile. The maximum length of the name you can set is 15 characters.
Black/White List	<p>Enable - Activate white/black list function for such profile.</p> <p>URL keywords - Click Edit to choose the group or object profile as the content of white/black list.</p> <p>Pass - allow accessing into the corresponding webpage with the characters listed on Group/Object Selections. If the web pages do not match with the specified feature set here, they will be processed with the categories listed on the box below.</p> <p>Block - restrict accessing into the corresponding webpage with the characters listed on Group/Object Selections.</p>

	If the web pages do not match with the specified feature set here, they will be processed with the categories listed on the box below.
Action	<p>Pass - allow accessing into the corresponding webpage with the categories listed on the box below.</p> <p>Block - restrict accessing into the corresponding webpage with the categories listed on the box below.</p> <p>If the web pages do not match with the specified feature set here, it will be processed with reverse action.</p>
Log	<p>Pass - Only the log about Pass will be recorded in Syslog.</p> <p>Block - Only the log about Block will be recorded in Syslog.</p> <p>All - All the actions (Pass and Block) will be recorded in Syslog.</p>

After finishing all the settings, please click OK to save the configuration.

Application Notes

A-1 How to Create an Account for MyVigor

The website of MyVigor (a server located on <http://myvigor.draytek.com>) provides several useful services (such as Anti-Spam, Web Content Filter, Anti-Intrusion, and etc.) to filtering the web pages for the sake of protecting your system.

To access into MyVigor for getting more information, please create an account for MyVigor.

Create an Account via Vigor Router

1. Click CSM>> Web Content Filter Profile. The following page will appear.

CSM >> Web Content Filter Profile ?

Web-Filter License
[Status:Not Activated] **Activate**

Setup Query Server	auto-selected	Find more
Setup Test Server	auto-selected	Find more

Web Content Filter Profile Table: Cache : L1 + L2 Cache ▾ | [Set to Factory Default](#) |

Profile	Name	Profile	Name
1.	Default	5.	
2.		6.	
3.		7.	
4.		8.	

Note:
To make Web Content Filter profile effective, please go to [Firewall >> Filter Setup](#) page to create a firewall rule and select the desired profile.

Administration Message (Max 255 characters) Default Message

```
<body><center><br><br><br><p>The requested Web page <br> from %STP% <br>to %URL% <br>that is
```

Or

Click System Maintenance>>Activation to open the following page.

System Maintenance >> Activation Activate via interface : auto-selected ▾

Web-Filter License
[Status:Not Activated] **Activate**

Authentication Message

Note: If you want to use email alert or syslog, please configure the [SysLog/Mail Alert Setup](#) page.

2. Click the **Activate** link. A login page for MyVigor web site will pop up automatically.

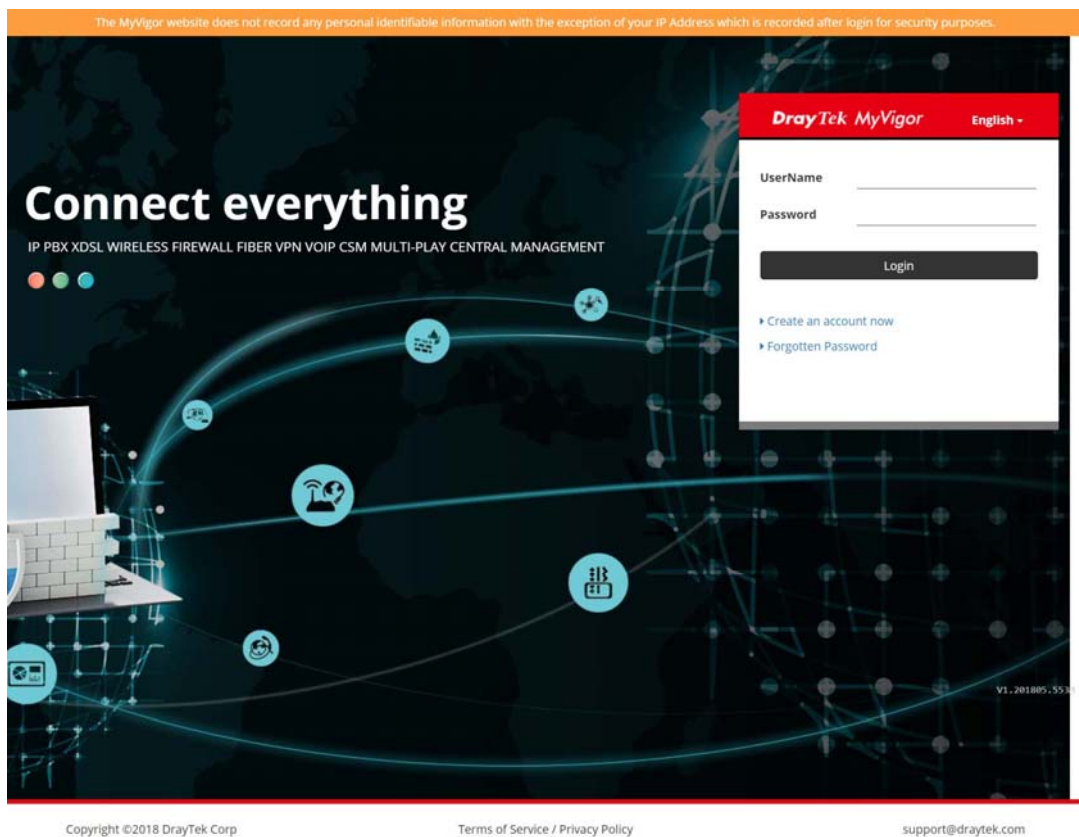

3. Click the link of **Create an account now**.
4. The system will ask if you are 16 years old or over.
 - If yes, click **I am 16 or over**.

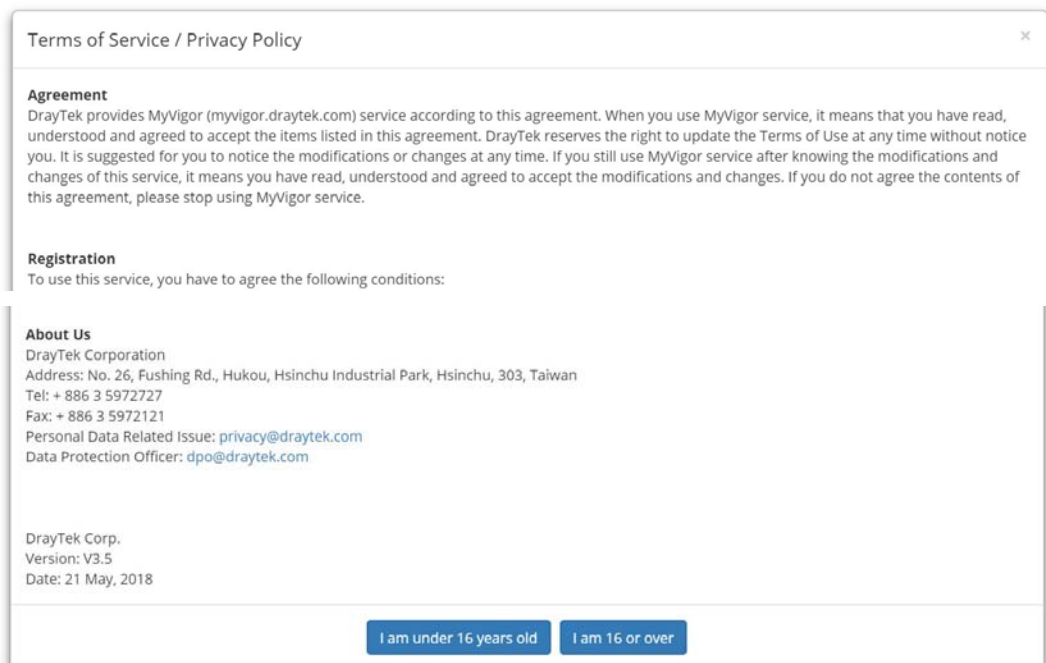

- If not, click I am under 16 years old to get the following page. Then, click I and my legal guardian agree.

this section 8.

About Us
 DrayTek Corporation
 Address: No. 26, Fushing Rd., Hukou, Hsinchu Industrial Park, Hsinchu, 303, Taiwan
 Tel: + 886 3 5972727
 Fax: + 886 3 5972121
 Personal Data Related Issue: privacy@draytek.com
 Data Protection Officer: dpo@draytek.com

DrayTek Corp.
 Version: V3.5
 Date: 21 May, 2018

5. After reading the terms of service/privacy policy, click Agree.

this section 8.

About Us
 DrayTek Corporation
 Address: No. 26, Fushing Rd., Hukou, Hsinchu Industrial Park, Hsinchu, 303, Taiwan
 Tel: + 886 3 5972727
 Fax: + 886 3 5972121
 Personal Data Related Issue: privacy@draytek.com
 Data Protection Officer: dpo@draytek.com

DrayTek Corp.
 Version: V3.5
 Date: 21 May, 2018

6. In the following page, enter your personal information in this page and then click Continue.

DrayTek MyVigor English ▾

Create an account - Please enter personal profile.

UserName Draytek_Document	Email Address draytek@draytek.com
<input type="text"/>	<input type="text"/>
Country TAIWAN	<input type="text"/>
Industry Other	<input type="text"/>
Password	<input type="text"/>
Confirm Password	<input type="text"/>

Do you agree to share your information to DrayTek office, regional distributor, local dealer and third party, in order to receive the newsletter or information from us?

Do you agree that MyVigor website can record your IP Address for security purposes?
 Your IP Address record will only be used for the purposes of detecting and preventing malicious login attempts.
 You can change the setting or clear the record at anytime.

I'm not a robot 

7. Choose proper selection for your computer and click **Continue**.

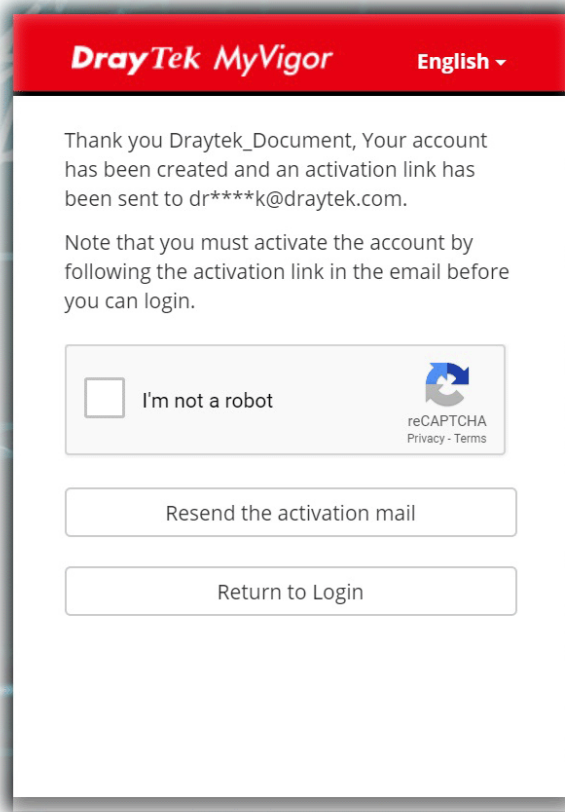

8. Now you have created an account successfully.
9. Check to see the confirmation *email* with the title of **New Account Confirmation Letter from myvigor.draytek.com**.

***** This is an automated message from myvigor.draytek.com.*****

Thank you (**Mary**) for creating an account.

Please click on the activation link below to activate your account

Link : [Activate my Account](#)

10. Click the **Activate my Account** link to enable the account that you created. The following screen will be shown to verify the register process is finished. Please click **Login**.

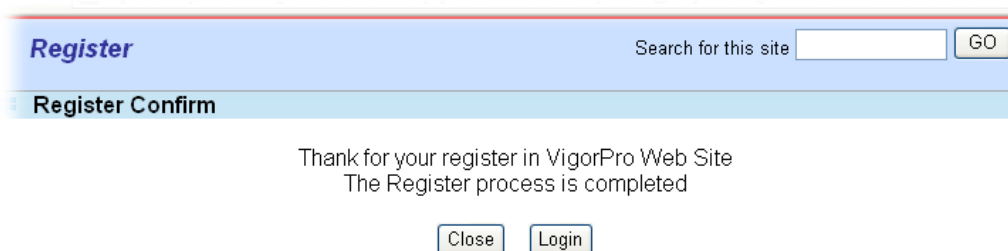

11. When you see the following page, please type in the account and password (that you just created) in the fields of **UserName** and **Password**.

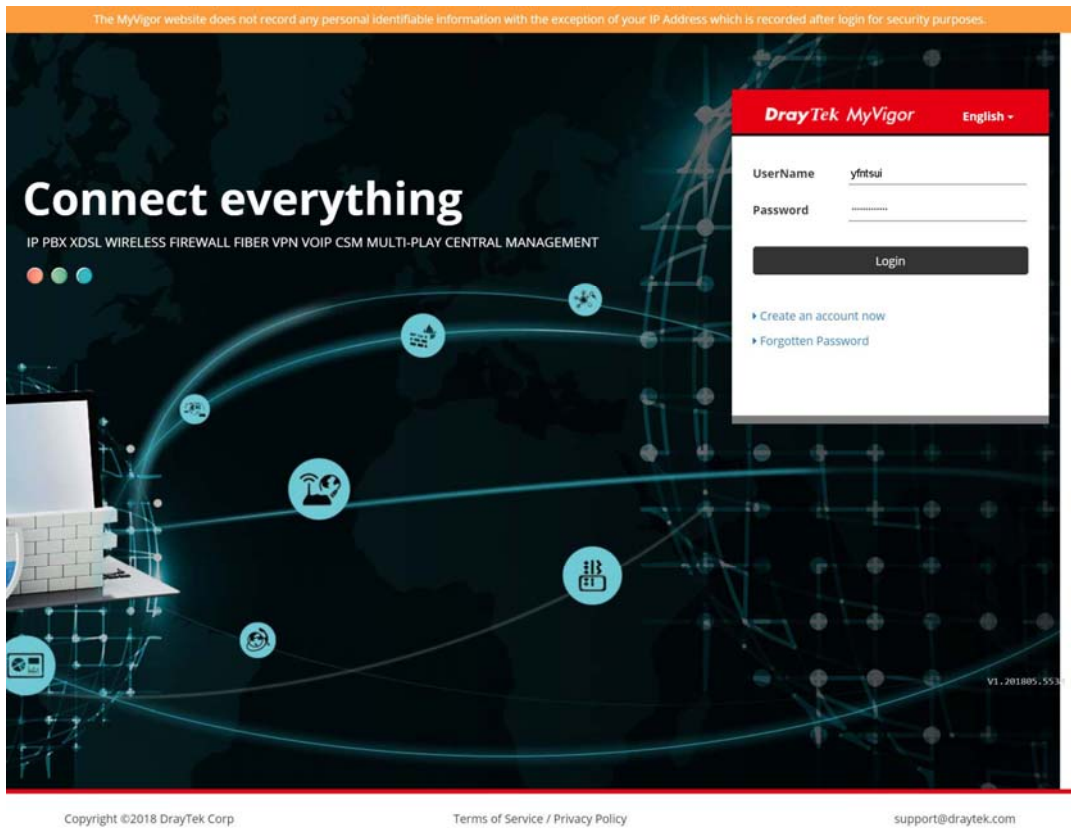

12. Now, click **Login**. Your account has been activated. You can access into MyVigor server to activate the service (e.g., WCF) that you want.

A-2 How to Block Facebook Service Accessed by the Users via Web Content Filter / URL Content Filter

There are two ways to block the facebook service, Web Content Filter and URL Content Filter.

Web Content Filter,

Benefits: Easily and quickly implement the category/website that you want to block.

Note: License is required.

URL Content Filter,

Benefits: Free, flexible for customize webpage.

Note: Manual setting (e.g., one keyword for one website.)

I. Via Web Content Filter

1. Make sure the Web Content Filter (powered by Commtouch) license is valid.

CSM >> Web Content Filter Profile

Web-Filter License

[Activate](#)

[Status: **Commtouch**] [Start Date: **2012-12-31** Expire Date: **2013-01-08**]

Setup Query Server

auto-selected

[Find more](#)

Setup Test Server

auto-selected

[Find more](#)

Web Content Filter Profile Table:

[Set to Factory Default](#)

Profile	Name	Profile	Name
1.	Default	5.	
2.		6.	
3.		7.	
4.		8.	

Administration Message (Max 255 characters)

Cache : [L1 + L2 Cache](#)

```
<body><center><br><br><br><p>The requested Web page <br> from %SIP% <br>to %URL%
<br>that is categorized with %CL% <br>has been blocked by %RNAME% Web Content
Filter.<p>Please contact your system administrator for further
information.</center></body>
```

- Open CSM >> Web Content Filter Profile to create a WCF profile. Check Social Networking with Action, Block.

The screenshot shows the 'Web Content Filter Profile' configuration page. It is divided into several sections: Business, Chatting, Computer-Internet, and Other. Each section has a 'Select All' and 'Clear All' button. The 'Computer-Internet' section contains a grid of checkboxes for various categories. The 'Social Networking' checkbox is checked and highlighted with a red box. Other categories include Anonymizers, Download Sites, Search Engine, Portals, Malware, Illegal Software, Forums & Newsgroups, Streaming, Downloads, Botnets, Information Security, Computers, Technology, Phishing & Fraud, Spam Sites, Hacking, Peer-to-Peer, Adv & Pop-Ups, Compromised, Finance, News, Arts, Dating & Personals, Government, Non-profits & NGOs, Real Estate, Transportation, Education, Health & Medicine, and Personal Sites.

- Enable this profile in Firewall >> General Setup >> Default Rule.

Firewall >> General Setup

General Setup

General Setup Default Rule

Actions for default rule:

Application	Action/Profile	Syslog
Filter	Pass	<input type="checkbox"/>
Sessions Control	65 / 60000	<input type="checkbox"/>
Quality of Service	None	<input type="checkbox"/>
Load-Balance policy	Auto-Select	<input type="checkbox"/>
User Management	None	<input type="checkbox"/>
APP Enforcement	None	<input type="checkbox"/>
URL Content Filter	None	<input type="checkbox"/>
Web Content Filter	1-Default	<input type="checkbox"/>
Advance Setting	None [Create New] 1-Default	

- Next time when someone accesses facebook via this router, the web page would be blocked and the following message would be displayed instead.

The requested Web page
from 192.168.2.114
to www.facebook.com/
that is categorized with [Social Networking]
has been blocked by Web Content Filter.

Please contact your system administrator for further information.

[Powered by DrayTek]

II. Via URL Content Filter

A. Block the web page containing the word of “Facebook”

1. Open Object Settings>>Keyword Object. Click an index number to open the setting page.
2. In the field of Contents, please type *facebook*. Configure the settings as the following figure.

Objects Setting >> Keyword Object Setup

Profile Index : 1

Name	Facebook
Contents	facebook

Limit of Contents: Max 3 Words and 63 Characters.
Each word should be separated by a single space.

You can replace a character with %HEX.
Example:
Contents: backdoo%72 virus keep%20out

Result:

1. backdoor
2. virus
3. keep out

OK Clear Cancel

3. Open CSM>>URL Content Filter Profile. Click an index number to open the setting page.
4. Configure the settings as the following figure.

CSM >> URL Content Filter Profile

Profile Index: 1

Profile Name: Facebook

Priority: Either : URL Access Control First Log: None

1.URL Access Control

Enable URL Access Control Prevent web access from IP address

Action: Block Group/Object Selections: Facebook

2.Web Feature

Enable Restrict Web Feature

Action: Pass Cookie Proxy Upload File Extension Profile: None

OK Clear Cancel

5. When you finished the above steps, click OK. Then, open Firewall>>General Setup.

- Click the **Default Rule** tab. Choose the profile just configured from the drop down list in the field of **URL Content Filter**. Now, users cannot open any web page with the word "facebook" inside.

Firewall >> General Setup

General Setup

General Setup Default Rule

Actions for default rule:	Action/Profile	Syslog
Application	Pass	<input type="checkbox"/>
Filter	0 / 60000	<input type="checkbox"/>
Sessions Control	None	<input type="checkbox"/>
Quality of Service	Auto-Select	<input type="checkbox"/>
Load-Balance policy	None	<input type="checkbox"/>
User Management	None	<input type="checkbox"/>
APP Enforcement	None	<input type="checkbox"/>
URL Content Filter	1-Facebook	<input type="checkbox"/>
Web Content Filter	None	<input type="checkbox"/>

Advance Setting Edit

B. Disallow users to play games on Facebook

- Open **Object Settings>>Keyword Object**. Click an index number to open the setting page.
- In the field of **Contents**, please type *apps.facebook*. Configure the settings as the following figure.

Objects Setting >> Keyword Object Setup

Profile Index : 2

Name	facebook-apps
Contents	apps.facebook

Limit of Contents: Max 3 Words and 63 Characters.
Each word should be separated by a single space.

You can replace a character with %HEX.
Example:
Contents: backdoo%72 virus keep%20out

Result:
1. backdoor
2. virus
3. keep out

OK Clear Cancel

- Open **CSM>>URL Content Filter Profile**. Click an index number to open the setting page.
- Configure the settings as the following figure.

Profile Index: 2

Profile Name:

Priority: Log:

1.URL Access Control

Enable URL Access Control Prevent web access from IP address

Action: Group/Object Selections:

2.Web Feature

Enable Restrict Web Feature

Action: Cookie Proxy Upload File Extension Profile:

5. When you finished the above steps, please open Firewall>>General Setup.
6. Click the **Default Rule** tab. Choose the profile just configured from the drop down list in the field of URL Content Filter. Now, users cannot open any web page with the word "facebook" inside.

General Setup

General Setup Default Rule

Actions for default rule:

Application	Action/Profile	Syslog
Filter	<input type="text" value="Pass"/>	<input type="checkbox"/>
Sessions Control	0 / <input type="text" value="60000"/>	<input type="checkbox"/>
<u>Quality of Service</u>	<input type="text" value="None"/>	<input type="checkbox"/>
Load-Balance policy	<input type="text" value="Auto-Select"/>	<input type="checkbox"/>
<u>User Management</u>	<input type="text" value="None"/>	<input type="checkbox"/>
<u>APP Enforcement</u>	<input type="text" value="None"/>	<input type="checkbox"/>
URL Content Filter	<input type="text" value="2-face.apps"/>	<input type="checkbox"/>
<u>Web Content Filter</u>	<input type="text" value="None"/>	<input type="checkbox"/>

Advance Setting

Part VI Management



System
Maintenance

There are several items offered for the Vigor router system setup: System Status, TR-069, Administrator Password, User Password, Configuration Backup, Syslog /Mail Alert, Time and Date, SNMP, Management, Panel Control, Self-Signed Certificate, Reboot System, Firmware Upgrade, and Activation.



Bandwidth
Management

It is used to control the bandwidth of data transmission through configuration of Sessions Limit, Bandwidth Limit, and Quality of Service (QoS).

VI-1 System Maintenance

For the system setup, there are several items that you have to know the way of configuration: System Status, TR-069, Administrator Password, User Password, Configuration Backup, Syslog /Mail Alert, Time and Date, SNMP, Management, Panel Control, Self-Signed Certificate, Reboot System, Firmware Upgrade and Activation.

Below shows the menu items for System Maintenance.

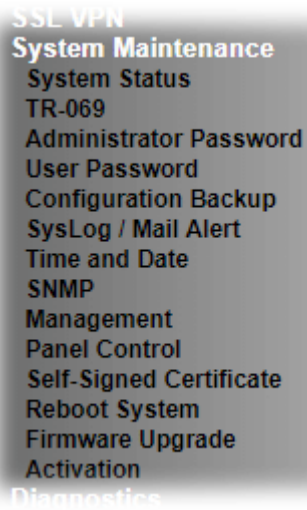

The image shows a screenshot of a web interface menu. The menu items are listed vertically and are highlighted with a grey background. The items are: SSL VPN, System Maintenance, System Status, TR-069, Administrator Password, User Password, Configuration Backup, SysLog / Mail Alert, Time and Date, SNMP, Management, Panel Control, Self-Signed Certificate, Reboot System, Firmware Upgrade, Activation, and Diagnostics.

- SSL VPN
- System Maintenance**
- System Status
- TR-069
- Administrator Password
- User Password
- Configuration Backup
- SysLog / Mail Alert
- Time and Date
- SNMP
- Management
- Panel Control
- Self-Signed Certificate
- Reboot System
- Firmware Upgrade
- Activation
- Diagnostics

Web User Interface

VI-1-1 System Status

The System Status provides basic network settings of Vigor router. It includes LAN and WAN interface information. Also, you could get the current running firmware version or firmware related information from this presentation.

System Status

Model Name : VigorLTE200n
 Firmware Version : 3.8.11
 Build Date/Time : Apr 17 2019 19:00:48

LAN					
	MAC Address	IP Address	Subnet Mask	DHCP Server	DNS
LAN1	00-1D-AA-93-AE-94	192.168.1.1	255.255.255.0	ON	8.8.8.8
LAN2	00-1D-AA-93-AE-94	192.168.2.1	255.255.255.0	ON	8.8.8.8
IP Routed Subnet	00-1D-AA-93-AE-94	192.168.0.1	255.255.255.0	ON	8.8.8.8

Wireless LAN				
MAC Address	Frequency Domain	Firmware Version	SSID	
00-1D-AA-93-AE-94	Europe	4.0.1.0rev2.P1	DrayTek	

WAN					
	Link Status	MAC Address	Connection	IP Address	Default Gateway
WAN2	Disconnected	00-1D-AA-93-AE-96	PPPoE	---	---
LTE	Disconnected	00-1D-AA-93-AE-97	---	---	---

IPv6			
	Address	Scope	Internet Access Mode
LAN	FE80::21D:AAFF:FE93:AE94/64	Link	---

User Mode is **OFF** now.

Available settings are explained as follows:

Item	Description
Model Name	Display the model name of the router.
Firmware Version	Display the firmware version of the router.
Build Date/Time	Display the date and time of the current firmware build.
LAN	MAC Address - Display the MAC address of the LAN Interface. IP Address - Display the IP address of the LAN interface. Subnet Mask - Display the subnet mask address of the LAN interface. DHCP Server - Display the current status of DHCP server of the LAN interface. DNS - Display the assigned IP address of the primary DNS.
WAN	Link Status - Display current connection status. MAC Address

	<ul style="list-style-type: none"> - Display the MAC address of the WAN Interface. <p>Connection</p> <ul style="list-style-type: none"> - Display the connection type. <p>IP Address</p> <ul style="list-style-type: none"> - Display the IP address of the WAN interface. <p>Default Gateway</p> <ul style="list-style-type: none"> - Display the assigned IP address of the default gateway.
IPv6	<p>Address - Display the IPv6 address for LAN.</p> <p>Scope - Display the scope of IPv6 address. For example, IPv6 Link Local could only be used for direct IPv6 link. It can't be used for IPv6 internet.</p> <p>Internet Access Mode - Display the connection mode chosen for accessing into Internet.</p>

VI-1-2 TR-069

This device supports TR-069 standard. It is very convenient for an administrator to manage a TR-069 device through an Auto Configuration Server, e.g., VigorACS.

System Maintenance >> TR-069 Setting

ACS and CPE Settings	Export Parameters
Tr069 <input checked="" type="radio"/> Disable <input type="radio"/> Enable ACS Server On <input type="text" value="Internet"/>	
ACS Server URL <input type="text"/> <input type="button" value="Wizard"/> <input type="checkbox"/> Acquire URL from DHCP option 43 Username <input type="text" value="Max: 31 characters"/> Password <input type="text" value="Max: 31 characters"/> <input type="button" value="Test With Inform"/> Event Code <input type="text" value="PERIODIC"/>	
Last Inform Response Time :(NA) ●	
CPE Client <input checked="" type="radio"/> Http <input type="radio"/> Https URL <input type="text"/> Port <input type="text" value="8069"/> Username <input type="text" value="vigor"/> Password <input type="text" value="*****"/>	
Periodic Inform Settings <input checked="" type="radio"/> Disable <input type="radio"/> Enable Interval Time <input type="text" value="900"/> second(s)	
STUN Settings <input checked="" type="radio"/> Disable <input type="radio"/> Enable Server Address <input type="text"/> Server Port <input type="text" value="3478"/> Minimum Keep Alive Period <input type="text" value="60"/> second(s) Maximum Keep Alive Period <input type="text" value="-1"/> second(s)	
Apply Settings to APs <input checked="" type="radio"/> Disable <input type="radio"/> Enable AP Password <input type="text"/> <input type="checkbox"/> Apply Specific STUN Settings to APs	
Note: If "Apply Specific STUN Settings to APs" is enabled, router STUN Settings would be discarded.	
<input type="button" value="OK"/> <input type="button" value="Clear"/>	

Available settings are explained as follows:

Item	Description
Tr069	Click Enable to activate the settings on this page.
ACS Server On	Choose the interface for the router connecting to ACS server.
ACS Server	URL/Username/Password - Such data must be typed according to the ACS (Auto Configuration Server) you want to link. Please refer to Auto Configuration Server user's manual for detailed information. Wizard - Click it to enter the IP address of VigorACS server, port number and the handler.

	<p>Test With Inform - Click it to send a message based on the event code selection to test if such CPE is able to communicate with VigorACS SI server.</p> <p>Event Code - Use the drop down menu to specify an event to perform the test.</p> <p>Last Inform Response Time - Display the time that VigorACS server made a response while receiving Inform message from CPE last time.</p>
CPE Client	<p>Such information is useful for Auto Configuration Server.</p> <p>Enable/Disable - Allow/Deny the CPE Client to connect with Auto Configuration Server.</p> <p>Port - Sometimes, port conflict might be occurred. To solve such problem, you might change port number for CPE.</p> <p>Username and Password - Enter the username and password that VigorACS can use to access into such CPE.</p>
Periodic Inform Settings	<p>The default setting is Enable. Please set interval time or schedule time for the router to send notification to CPE. Or click Disable to close the mechanism of notification.</p>
STUN Settings	<p>The default is Disable. If you click Enable, please Enter the relational settings listed below:</p> <p>Server Address - Enter the IP address of the STUN server.</p> <p>Server Port - Enter the port number of the STUN server.</p> <p>Minimum Keep Alive Period - If STUN is enabled, the CPE must send binding request to the server for the purpose of maintaining the binding in the Gateway. Please type a number as the minimum period. The default setting is "60 seconds".</p> <p>Maximum Keep Alive Period - If STUN is enabled, the CPE must send binding request to the server for the purpose of maintaining the binding in the Gateway. Please type a number as the maximum period. A value of "-1" indicates that no maximum period is specified.</p>
Apply Settings to APs	<p>This feature is able to apply TR-069 settings (including STUN and ACS server settings) to all of APs managed by VigorLTE 200 at the same time.</p> <p>Disable - Related settings will not be applied to VigorAP.</p> <p>Enable - Above STUN settings will be applied to VigorAP after clicking OK. If such feature is enabled, you have to Enter the password for accessing VigorAP.</p> <p>AP Password - Enter the password of the VigorAP that you want to apply VigorLTE 200's TR-069 settings.</p> <p>Apply Specific STUN Settings to APs - After clicking the Enable radio button for Apply Settings to APs, if you want to apply specific STUN settings (not the STUN Settings configured for VigorLTE 200) to VigorAPs to meet specific requirements, simply check this box. Then, Enter the server IP address, server port, minimum keep alive period and maxmum keep alive period respectively.</p>

After finishing all the settings here, please click OK to save the configuration.

VI-1-3 Administrator Password

This page allows you to set new password.

System Maintenance >> Administrator Password Setup

Administrator Password

Old Password	<input type="text"/>	Max: 23 characters
New Password	<input type="text"/>	(Max. 23 characters allowed)
Confirm Password	<input type="text"/>	(Max. 23 characters allowed)

Note:

Password can contain only a-z A-Z 0-9 , ; : . " < > * + = | ? @ # ^ ! ()

OK

Available settings are explained as follows:

Item	Description
Administrator Password	<p>Old Password - Enter the old password. The factory default setting for password is "admin".</p> <p>New Password -Enter new password in this field. The length of the password is limited to 23 characters.</p> <p>Confirm Password -Enter the new password again.</p>

When you click OK, the login window will appear. Please use the new password to access into the web user interface again.

VI-1-4 User Password

This page allows you to set new password for user operation.

System Maintenance >> User Password

Enable User Mode for simple web configuration

User Password

| [Set to Factory Default](#) |

Password	<input type="password"/>	
Confirm Password	<input type="password"/>	(Max. 23 characters allowed)
Password Strength:	Weak Medium Strong	
Strong password requirements:		
1. Have at least one upper-case letter and one lower-case letter.		
2. Including non-alphanumeric characters is a plus.		

Note:

1. Password can contain a-z A-Z 0-9 , ; : . " < > * + = | ? @ # ^ ! ()
2. Password can't be all asterisks(*). For example, '*' or '***' is illegal, but '*23*' or '*45' is OK.

OK

Available settings are explained as follows:

Item	Description
Enable User Mode for simple web configuration	After checking this box, you can access into the web user interface with the password typed here for simple web configuration. The settings on simple web user interface will be different with full web user interface accessed by using the administrator password.
Password	Enter new password in this field. The length of the password is limited to 31 characters.
Confirm Password	Enter the new password again.
Password Strength	Display the security strength of the password specified above.
Set to Factory Default	Click to return to the factory default setting.

When you click OK, the login window will appear. Please use the new password to access into the web user interface again. Below shows an example for accessing into User Operation with User Password.

1. Open System Maintenance>>User Password.
2. Check the box of **Enable User Mode for simple web configuration** to enable user mode operation. Type a new password in the field of New Password and click OK.

System Maintenance >> User Password

Enable User Mode for simple web configuration

User Password

| [Set to Factory Default](#) |

Password	<input type="password"/>	(Max. 23 characters allowed)
Confirm Password	<input type="password"/>	(Max. 23 characters allowed)
Password Strength:	Weak Medium Strong	
Strong password requirements:		
1. Have at least one upper-case letter and one lower-case letter.		
2. Including non-alphanumeric characters is a plus.		

3. The following screen will appear. Simply click **OK**.

System Maintenance >> User Password

Active Configuration

Password : *****

4. Log out Vigor router web user interface by clicking the Logout button.



5. The following window will be open to ask for username and password. Enter the new user password in the field of Password and click **Login**.



DrayTek VigorLTE 200 Series

Login

Username

Password

Login

Security Warning: You are logging in without encryption which is not recommended. To login securely [click here](#).

Copyright © 2000- 2018 DrayTek Corp. All Rights Reserved.

6. The main screen with User Mode will be shown on the web page.
Settings to be configured in User Mode will be less than settings in Admin Mode. Only basic configuration settings will be available in User Mode.



Info

Setting in User Mode can be configured as same as in Admin Mode.

VI-1-5 Configuration Backup

Such function can be used to apply the router settings configured by other Vigor router to VigorLTE 200.

Backup the Configuration

Follow the steps below to backup your configuration.

1. Go to **System Maintenance >> Configuration Backup**. The following page will be popped-up, as shown below.

System Maintenance >> Configuration Backup

Configuration Backup / Restoration

Restore

Restore settings from a configuration file.

選擇檔案 未選擇任何檔案

Click Restore to upload the file.

Backup

Back up the current settings into a configuration file.

Available settings are explained as follows:

Item	Description
Restore	Choose File - Click it to specify a file to be restored. Restore - Restore the configuration. If the file is encrypted, the system will ask you to Enter the password to decrypt the configuration file.
Backup	Click it to perform the configuration backup of this router.

2. Click **Backup** button to get into the following dialog. Click **Save** button to open another dialog for saving configuration as a file.

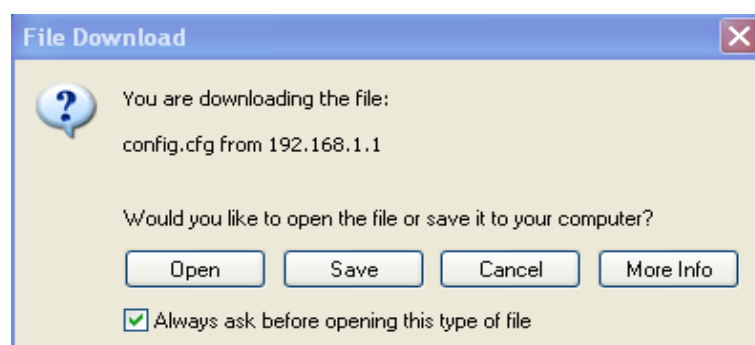

3. In **Save As** dialog, the default filename is **config.cfg**. You could give it another name by yourself.

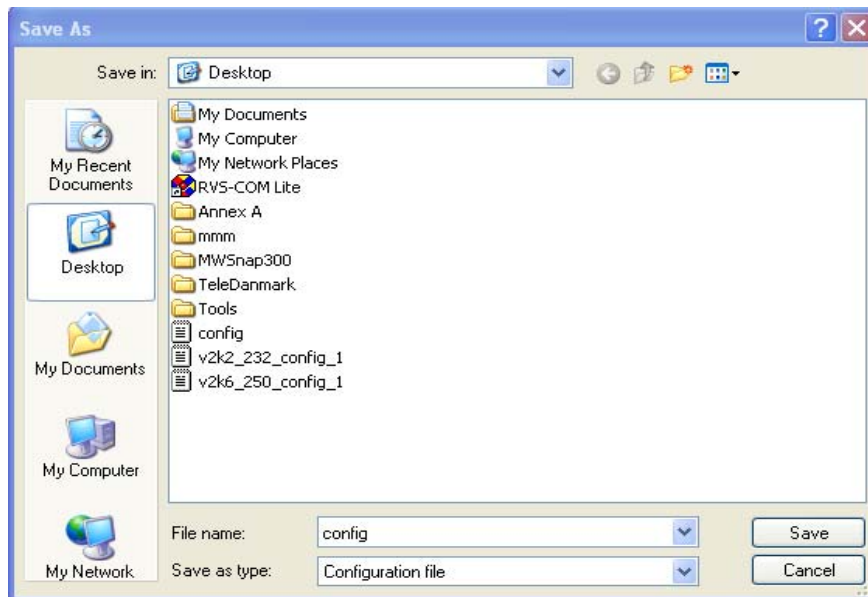

4. Click **Save** button, the configuration will download automatically to your computer as a file named **config.cfg**.

The above example is using **Windows** platform for demonstrating examples. The **Mac** or **Linux** platform will appear different windows, but the backup function is still available.



Info

Backup for Certification must be done independently. The Configuration Backup does not include information of Certificate.

Restore Configuration

1. Go to **System Maintenance >> Configuration Backup**. The following windows will be popped-up, as shown below.

System Maintenance >> Configuration Backup

Configuration Backup / Restoration

<p>Restore</p> <p>Restore settings from a configuration file.</p> <p><input checked="" type="radio"/> 選擇檔案 <input type="radio"/> 未選擇任何檔案</p> <p>Click Restore to upload the file.</p> <p><input type="button" value="Restore"/></p>
<p>Backup</p> <p>Back up the current settings into a configuration file.</p> <p><input type="button" value="Backup"/></p>

2. Click **Choose File** button to choose the correct configuration file for uploading to the router.
3. Click **Restore** button and wait for few seconds, the following picture will tell you that the restoration procedure is successful.

VI-1-6 Syslog/Mail Alert

SysLog function is provided for users to monitor router.

System Maintenance >> SysLog / Mail Alert Setup

SysLog / Mail Alert Setup

<p>SysLog Access Setup</p> <p><input type="checkbox"/> Enable</p> <p>Syslog Save to:</p> <p><input checked="" type="checkbox"/> Syslog Server</p> <p>Router Name <input style="width: 100%;" type="text" value="DrayTek"/></p> <p>Server IP/Hostname <input style="width: 100%;" type="text"/></p> <p>Destination Port <input style="width: 100%;" type="text" value="514"/></p> <p>Enable syslog message:</p> <p><input checked="" type="checkbox"/> Firewall Log</p> <p><input checked="" type="checkbox"/> VPN Log</p> <p><input checked="" type="checkbox"/> User Access Log</p> <p><input checked="" type="checkbox"/> WAN Log</p> <p><input checked="" type="checkbox"/> Router/DSL information</p> <p><input checked="" type="checkbox"/> WLAN Log</p>	<p>Mail Alert Setup</p> <p><input type="checkbox"/> Enable <input style="float: right;" type="button" value="Send a test e-mail"/></p> <p>SMTP Server <input style="width: 100%;" type="text"/></p> <p>SMTP Port <input style="width: 100%;" type="text" value="25"/></p> <p>Mail To <input style="width: 100%;" type="text"/></p> <p>Return-Path <input style="width: 100%;" type="text"/></p> <p><input type="checkbox"/> Use SSL</p> <p><input type="checkbox"/> Authentication</p> <p>Username <input style="width: 100%;" type="text"/></p> <p>Password <input style="width: 100%;" type="text"/></p> <p>Enable E-Mail Alert:</p> <p><input checked="" type="checkbox"/> DoS Attack</p> <p><input checked="" type="checkbox"/> APPE</p> <p><input checked="" type="checkbox"/> VPN LOG</p> <p><input type="checkbox"/> Debug Log</p>
---	--

Available settings are explained as follows:

Item	Description
SysLog Access Setup	<p>Enable - Check Enable to activate function of syslog.</p> <p>Syslog Save to - Check Syslog Server to save the log to Syslog server.</p>
Router Name	<p>Display the name for such router configured in System Maintenance>>Management.</p> <p>If there is no name here, simply lick the link to access into System Maintenance>>Management to set the router name.</p> <p>Server IP /Hostname -The IP address of the Syslog server.</p> <p>Destination Port - Assign a port for the Syslog protocol.</p> <p>Enable syslog message - Check the box listed on this web page to send the corresponding message of firewall, VPN, User Access, WAN, Router/DSL information and WLAN to Syslog.</p>
Mail Alert Setup	<p>Check Enable to activate function of mail alert.</p> <p>Send a test e-mail - Make a simple test for the e-mail address specified in this page. Please assign the mail address first and click this button to execute a test for verify the mail address is available or not.</p> <p>SMTP Server/SMTP Port - The IP address/Port number of the SMTP server.</p> <p>Mail To - Assign a mail address for sending mails out.</p> <p>Return-Path - Assign a path for receiving the mail from outside.</p> <p>Use SSL - Check this box to use port 465 for SMTP server for</p>

some e-mail server uses https as the transmission method.

Authentication - Check this box to activate this function while using e-mail application.

User Name - Enter the user name for authentication.

Password - Enter the password for authentication.

Enable E-mail Alert - Check the box to send alert message to the e-mail box while the router detecting the item(s) you specify here.

Click OK to save these settings.

For viewing the Syslog, please do the following:

1. Just set your monitor PC's IP address in the field of Server IP Address
2. Install the Router Tools in the Utility within provided CD. After installation, click on the Router Tools>>Syslog from program menu.

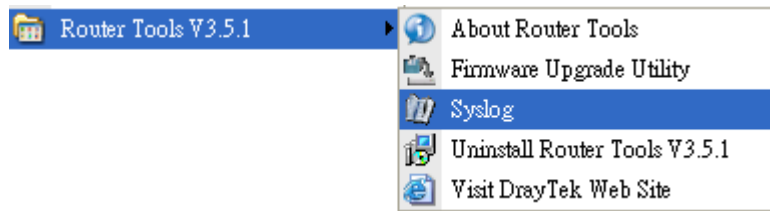

3. From the Syslog screen, select the router you want to monitor. Be reminded that in **Network Information**, select the network adapter used to connect to the router. Otherwise, you won't succeed in retrieving information from the router.

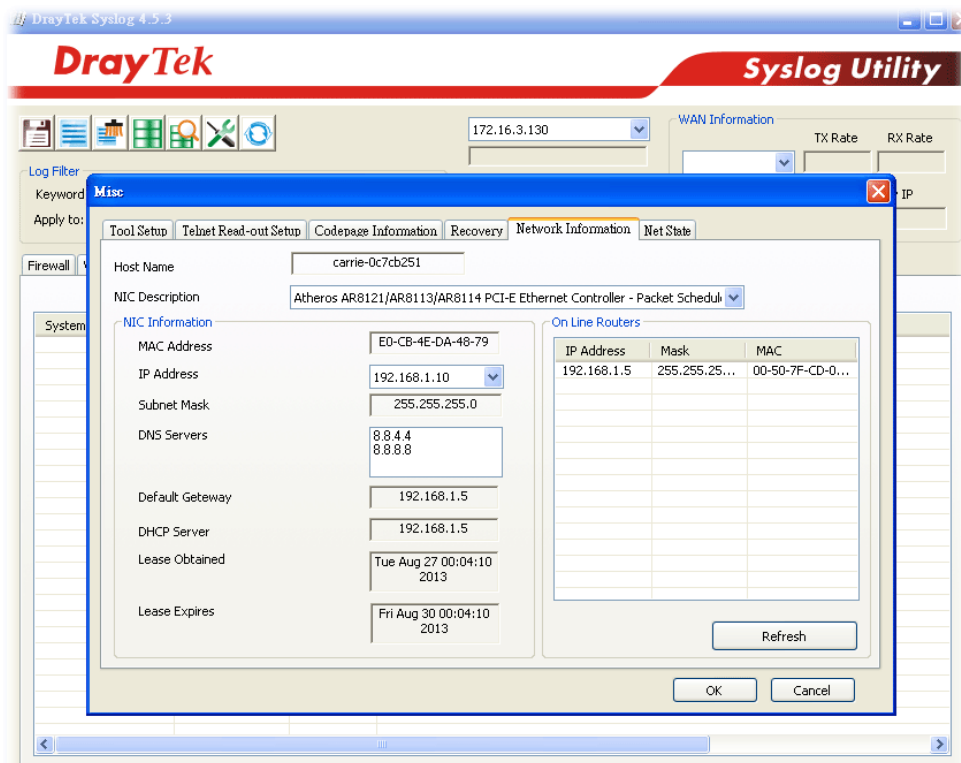

System Time: Time taken from the computer which runs the custom application.

Router Time: Time taken from router.

VI-1-7 Time and Date

It allows you to specify where the time of the router should be inquired from.

System Maintenance >> Time and Date

Time Information

Current System Time	2000 Jan 4 Tue 18 : 22 : 53	Inquire Time
---------------------	-----------------------------	--------------

Time Setup

<input type="radio"/> Use Browser Time	
<input checked="" type="radio"/> Use Internet Time	
Time Server	pool.ntp.org
Priority	Auto
Time Zone	(GMT) Greenwich Mean Time : Dublin
Enable Daylight Saving	<input type="checkbox"/> Advanced
Automatically Update Interval	30 min
Send NTP Request Through	Auto

OK Cancel

Available settings are explained as follows:

Item	Description									
Current System Time	Click Inquire Time to get the current time.									
Use Browser Time	Select this option to use the browser time from the remote administrator PC host as router's system time.									
Use Internet Time	Select to inquire time information from Time Server on the Internet using assigned protocol.									
Time Server	Enter the web site of the time server.									
Priority	Choose Auto or IPv6 First as the priority.									
Time Zone	Select the time zone where the router is located.									
Enable Daylight Saving	Check the box to enable the daylight saving. Such feature is available for certain area. Advanced - Click it to open a pop up dialog. <div data-bbox="715 1541 1406 1895" data-label="Form"> <p>Daylight Saving Advanced</p> <table border="1"> <tr> <td><input checked="" type="radio"/> Default</td> <td>Start: Last Sunday in March</td> <td>End: Last Sunday in October</td> </tr> <tr> <td><input type="radio"/> Customized: By Date</td> <td>Start: Month Day 00:00</td> <td>End: Month Day 00:00</td> </tr> <tr> <td><input type="radio"/> Customized: By Weekday</td> <td>Start: January First Sunday 00:00</td> <td>End: January First Sunday 00:00</td> </tr> </table> <p>OK Close</p> </div>	<input checked="" type="radio"/> Default	Start: Last Sunday in March	End: Last Sunday in October	<input type="radio"/> Customized: By Date	Start: Month Day 00:00	End: Month Day 00:00	<input type="radio"/> Customized: By Weekday	Start: January First Sunday 00:00	End: January First Sunday 00:00
<input checked="" type="radio"/> Default	Start: Last Sunday in March	End: Last Sunday in October								
<input type="radio"/> Customized: By Date	Start: Month Day 00:00	End: Month Day 00:00								
<input type="radio"/> Customized: By Weekday	Start: January First Sunday 00:00	End: January First Sunday 00:00								
Automatically Update	Select a time interval for updating from the NTP server.									

Interval	
Send NTP Request Through	Specify a WAN interface to send NTP request for time synchronization.

Click OK to save these settings.

VI-1-8 SNMP

This page allows you to configure settings for SNMP and SNMPV3 services.

The SNMPv3 is more secure than SNMP through the encryption method (support AES and DES) and authentication method (support MD5 and SHA) for the management needs.

System Maintenance >> SNMP

SNMP Setup

Enable SNMP Agent

Get Community

Set Community

Manager Host IP(IPv4)

Index	IP	Subnet Mask
1	<input type="text"/>	<input type="text"/>
2	<input type="text"/>	<input type="text"/>
3	<input type="text"/>	<input type="text"/>

Manager Host IP(IPv6)

Index	IPv6 Address	/ Prefix Length
1	<input type="text"/>	<input type="text" value="/0"/>
2	<input type="text"/>	<input type="text" value="/0"/>
3	<input type="text"/>	<input type="text" value="/0"/>

Trap Community

Notification Host IP(IPv4)

Index	IP
1	<input type="text"/>
2	<input type="text"/>

Notification Host IP(IPv6)

Index	IPv6 Address
1	<input type="text"/>
2	<input type="text"/>

Trap Timeout

Enable SNMPV3 Agent

USM User

Auth Algorithm

Auth Password

Privacy Algorithm

Privacy Password

Note:

SNMP service also shall be enabled for Internet access in [System Maintenance >> Management](#).

OK Cancel

Available settings are explained as follows:

Item	Description
Enable SNMP Agent	Check it to enable this function.
Get Community	Set the name for getting community by typing a proper character. The default setting is public . The maximum length of the text is limited to 23 characters.
Set Community	Set community by typing a proper name. The default setting is private .

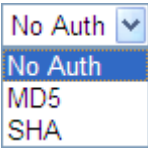
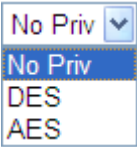
	The maximum length of the text is limited to 23 characters.
Manager Host IP (IPv4)	Set one host as the manager to execute SNMP function. Please Enter IPv4 address to specify certain host.
Manager Host IP (IPv6)	Set one host as the manager to execute SNMP function. Please Enter IPv6 address to specify certain host.
Trap Community	Set trap community by typing a proper name. The default setting is public . The maximum length of the text is limited to 23 characters.
Notification Host IP (IPv4)	Set the IPv4 address of the host that will receive the trap community.
Notification Host IP (IPv6)	Set the IPv6 address of the host that will receive the trap community.
Trap Timeout	The default setting is 10 seconds.
Enable SNMPV3 Agent	Check it to enable this function.
USM User	USM means user-based security mode. Type a username which will be used for authentication. The maximum length of the text is limited to 23 characters.
Auth Algorithm	Choose one of the encryption methods listed below as the authentication algorithm. 
Auth Password	Type a password for authentication. The maximum length of the text is limited to 23 characters.
Privacy Algorithm	Choose one of the methods listed below as the privacy algorithm. 
Privacy Password	Type a password for privacy. The maximum length of the text is limited to 23 characters.

Click OK to save these settings.

VI-1-9 Management

This page allows you to manage the settings for Internet/LAN Access Control, Access List from Internet, Management Port Setup, TLS/SSL Encryption Setup, CVM Access Control and Device Management.

The management pages for IPv4 and IPv6 protocols are different.

For IPv4

System Maintenance >> Management



IPv4 Management Setup	IPv6 Management Setup												
Router Name: <input type="text" value="DrayTek"/>													
<input type="checkbox"/> Default: Disable Auto-Logout													
Internet Access Control <input type="checkbox"/> Allow management from the Internet Domain name allowed: <input type="text"/>													
<input type="checkbox"/> FTP Server <input type="checkbox"/> HTTP Server <input type="checkbox"/> Enforce HTTPS Access <input checked="" type="checkbox"/> HTTPS Server <input type="checkbox"/> Telnet Server <input type="checkbox"/> TR069 Server <input type="checkbox"/> SSH Server <input checked="" type="checkbox"/> Disable PING from the Internet													
LAN Access Control <input checked="" type="checkbox"/> Allow management from LAN <input checked="" type="checkbox"/> FTP Server <input checked="" type="checkbox"/> HTTP Server <input type="checkbox"/> Enforce HTTPS Access <input checked="" type="checkbox"/> HTTPS Server <input checked="" type="checkbox"/> Telnet Server <input checked="" type="checkbox"/> TR069 Server <input checked="" type="checkbox"/> SSH Server Apply To Subnet <input checked="" type="checkbox"/> LAN1 <input checked="" type="checkbox"/> LAN2 <input checked="" type="checkbox"/> IP Routed Subnet													
Access List from the Internet <table border="1"> <thead> <tr> <th>List</th> <th>IP</th> <th>Subnet Mask</th> </tr> </thead> <tbody> <tr> <td>1</td> <td><input type="text"/></td> <td><input type="text"/></td> </tr> <tr> <td>2</td> <td><input type="text"/></td> <td><input type="text"/></td> </tr> <tr> <td>3</td> <td><input type="text"/></td> <td><input type="text"/></td> </tr> </tbody> </table>	List	IP	Subnet Mask	1	<input type="text"/>	<input type="text"/>	2	<input type="text"/>	<input type="text"/>	3	<input type="text"/>	<input type="text"/>	
List	IP	Subnet Mask											
1	<input type="text"/>	<input type="text"/>											
2	<input type="text"/>	<input type="text"/>											
3	<input type="text"/>	<input type="text"/>											
	Management Port Setup <input checked="" type="radio"/> User Define Ports <input type="radio"/> Default Ports Telnet Port: <input type="text" value="23"/> (Default: 23) HTTP Port: <input type="text" value="80"/> (Default: 80) HTTPS Port: <input type="text" value="443"/> (Default: 443) FTP Port: <input type="text" value="21"/> (Default: 21) TR069 Port: <input type="text" value="8069"/> (Default: 8069) SSH Port: <input type="text" value="22"/> (Default: 22)												
	Brute Force Protection <input type="checkbox"/> Enable brute force login protection <input type="checkbox"/> FTP Server <input type="checkbox"/> HTTP Server <input type="checkbox"/> HTTPS Server <input type="checkbox"/> Telnet Server <input type="checkbox"/> TR069 Server <input type="checkbox"/> SSH Server Maximum login failures: <input type="text" value="0"/> times Penalty period: <input type="text" value="0"/> seconds												
	Blocked IP List TLS/SSL Encryption Setup <input checked="" type="checkbox"/> Enable TLS 1.2 <input checked="" type="checkbox"/> Enable TLS 1.1 <input checked="" type="checkbox"/> Enable TLS 1.0 <input type="checkbox"/> Enable SSL 3.0												
	AP Management <input checked="" type="checkbox"/> Enable AP Management Device Management <input type="checkbox"/> Respond to external device												
<input type="button" value="OK"/>													

Available settings are explained as follows:

Item	Description
Router Name	Enter the router name provided by ISP.
Default: Disable Auto-Logout	If it is enabled, the function of auto-logout for web user interface will be disabled.  The web user interface will be open until you click the

	<p>Logout icon manually.</p> 
Internet Access Control	<p>Allow management from the Internet - Enable the checkbox to allow system administrators to login from the Internet. There are several servers provided by the system to allow you managing the router from Internet. Check the box(es) to specify.</p> <p>Disable PING from the Internet - Check the checkbox to reject all PING packets from the Internet. For security issue, this function is enabled by default.</p>
LAN Access Control	<p>Allow management from LAN - Enable the checkbox to allow system administrators to login from LAN interface. There are several servers provided by the system which allow you to manage the router from LAN interface. Check the box(es) to specify.</p> <p>Apply To Subnet - Check the LAN interface for the administrator to use for accessing into web user interface of Vigor router.</p>
Access List from the Internet	<p>You could specify that the system administrator can only login from a specific host or network defined in the list. A maximum of three IPs/subnet masks is allowed.</p>
Management Port Setup	<p>User Define Ports - Check to specify user-defined port numbers for the Telnet, HTTP, HTTPS, FTP, TR-069 and SSH servers.</p> <p>Default Ports - Check to use standard port numbers for the Telnet and HTTP servers.</p>
Brute Force Protection	<p>Any client trying to access into Internet via Vigor router will be asked for passing through user authentication. Such feature can prevent Vigor router from attacks when a hacker tries every possible combination of letters, numbers and symbols until find out the correct combination of password.</p> <p>Enable brute force login protection - Enable the protection mechanism.</p> <p>Maximum login failure - Specify the maximum number of wrong password that client can try for logging to Vigor router.</p> <p>Penalty period - Set a period of time to block the IP address which is used (by user or hacker) for passing through the user authentication again and again but failed always. When the time is up, Vigor system will unblock that IP and allow it to access into Vigor router again.</p> <p>Blocked IP List - Open another web page which displays current blocked IPs.</p>
TLS/SSL Encryption Setup	<p>Enable SSL 3.0 and / or TLS 1.0/1.1/1.2 - Check the box to enable the function of SSL 3.0 and/or TLS 1.0/1.1/1.2 if required.</p> <p>Due to security consideration, the built-in HTTPS and SSL VPN server of the router had upgraded to TLS1.x protocol. If you are using old browser(eg. IE6.0) or old SmartVPN Client, you may still need to enable SSL 3.0 to make sure you can</p>

	connect, however, it's not recommended.
AP Management	Enable AP Management - Check it to enable the function of Central Management>>AP . If unchecked, menu items related to Central Management>>AP will be hidden.
Device Management	Check the box to enable the device management function for VigorLTE 200. Respond to external device - If it is enabled, VigorLTE 200 will be regarded as slave device. When the external device (master device) sends request packet to VigorLTE 200, VigorLTE 200 would send back information to respond the request coming from the external device which is able to manage VigorLTE 200.

After finished the above settings, click **OK** to save the configuration.

For IPv6

System Maintenance >> Management ?

IPv4 Management Setup	IPv6 Management Setup
<p>Management Access Control</p> <p><input type="checkbox"/> Allow management from the Internet</p> <ul style="list-style-type: none"> <input type="checkbox"/> Telnet Server (Port : 23) <input type="checkbox"/> HTTP Server (Port : 80) <input type="checkbox"/> HTTPS Server (Port : 443) <input type="checkbox"/> SSH Server (Port : 22) <p><input checked="" type="checkbox"/> Disable PING from the Internet</p> <hr/> <p>Access List</p> <p>List IPv6 Address / Prefix Length</p> <p>1. <input style="width: 150px;" type="text"/> / <input style="width: 50px;" type="text"/></p> <p>2. <input style="width: 150px;" type="text"/> / <input style="width: 50px;" type="text"/></p> <p>3. <input style="width: 150px;" type="text"/> / <input style="width: 50px;" type="text"/></p> <p>Note: Telnet / Http server port is the same as IPv4.</p>	
<input type="button" value="OK"/>	

Available settings are explained as follows:

Item	Description
Management Access Control	Allow management from the Internet - Enable the checkbox to allow system administrators to login from the Internet. There are several servers provided by the system to allow you managing the router from Internet. Check the box(es) to specify. Disable PING from the Internet - Check the checkbox to disable all PING packets from the Internet. For security issue, this function is enabled by default.
Access List	You could specify that the system administrator can only login from a specific host or network defined in the list. A maximum of three IPs/subnet masks is allowed.

After finished the above settings, click **OK** to save the configuration.

VI-1-10 Panel Control

The behavior of the buttons on the front panel of the Vigor router can be customized as desired.

For Button

The **Factory Reset** and **Wireless ON/OFF/WPS** buttons on the front panel are enabled by default and can be enabled or disabled if required. Disabling the **Factory Reset** button will prevent tampering by unauthorized parties, or to avoid accidental triggering of a router reset when being used wake up LEDs. Disabling the wireless button will prevent changing the wireless setting when LED Sleep Mode is enabled, and the buttons are primarily used to turn the LEDs on and off.

Click the **Button** tab to get the following page.

System Maintenance >> Panel Control

Enable	Button
<input checked="" type="checkbox"/>	Wireless
<input checked="" type="checkbox"/>	Factory Reset

OK

Available settings are explained as follows:

Item	Description
Refresh	Click to refresh the page to display the latest information.
Enable Wireless Button	The default value is Enabled . Deselect to disable the ability of the Wireless button to control WLAN and WPS functions. Disabling the wireless button only prevents it from being used to control WLAN functions. It can still be used to wake up the LEDs when LED sleep mode is enabled.
Enable Factory Reset Button	The default value is Enabled . Deselect to disable the reset function of the factory reset button. Disabling the Factory Reset button only prevents it from being used to reboot Vigor router with default settings. It can still be used to wake up the LEDs when LED sleep mode is enabled.

After finished the above settings, click **OK** to save the configuration.

VI-1-11 Self-Signed Certificate

A self-signed certificate is a *unique* identification for the device (e.g., Vigor router) which generates the certificate by itself to ensure the router security. Such self-signed certificate is signed with its own private key.

The self-signed certificate will be applied in SSL VPN, HTTPS, and so on. In addition, it can be created for free by using a wide variety of tools.

System Maintenance >> Self-Signed Certificate

Self-Signed Certificate Information

Certificate Name :	self-signed
Issuer :	C=TW, ST=HsinChu, L=HuKou, O=DrayTek Corp., OU=DrayTek Support, CN=Vigor Router
Subject :	C=TW, ST=HsinChu, L=HuKou, O=DrayTek Corp., OU=DrayTek Support, CN=Vigor Router
Subject Alternative Name :	
Valid From :	Feb 11 12:29:49 2019 GMT
Valid To :	Feb 10 12:29:49 2049 GMT
PEM Format Content :	<pre> -----BEGIN CERTIFICATE----- MIIDIjCCAnKgAwIBAgIJAJKzi/STtveRMA0GCSqGSIb3DQEBCwUAMHgx CzA JBgNV BAYTA1RXMRAwDgYDVQQIDAdIc2luQ2h1MQ4wDAYDVQQHDAVIdUvdtdEWMBQGA1UE CgwNRHJheVRlayBDb3JwLjEYMBYGA1UECwwPRHJheVRlayBtdXBw3J0MRUwEwYD VQDDAxwldvc iBSb3V0ZXIwHhcNMTkwMjExMTIyOTQ5wHcNNDkwMjEwMTIyOTQ5 WjB4MQswCQYDVQQGEwJUVzEQMA4GA1UECAwHSHNpbkNodTEOMAwGA1UEBwwvFShVL b3Ux FjAUBGNVBAoMDURyYX1UZnsgQ29ycC4xGDAwBgNVBA sMD0RyYX1UZnsgU3Vw cG9ydEVMbMGA1UEAwwMVm1nb3I gUm91dGVyMIIBIjANBgkqhkiG9w0BAQEFAAOC AQ8AMIIBCGKCAQEAtga60wzf3htgFPMDT2JI tRMsu02yviXPskck/ j j03phNf8 7EgIj3QutBhId+DGXvBv3M+EbsbMZXPL0HVepF1sDZRZ0ZvedfE1kh4rRZ09boug 56QqLxUg1zGR+jWzozEn8SCcpvJ8r5Lwq78JQWn+XXFe9Kth3W8MVP0Z7T ip1uaN VX71IacZqjwNQwyEw+7NHc rLH/xGj0nZ3rdbJhYdHh iu62wgxnA203Zq2A2fzw1 rBB8N1weISDDZyk/wOHLn6JwJz0Tz3Wj5kz pynUIkHo0Qoas2YbxoWm3DRNiT0b4 AMxthJ2PakRAq648d4KAmwbZxgChw3DyGXaFUQIDAQABoxcwfTATBgNVHUEDDAK BggrBgEFBQcDATANBgkqhkiG9w0BAQsFAAOCAQEAnA+05/ kppOxKpv8K766tKWXd s25b1ypQGFf qxHXbX0dhkAsBceHp4TeCnFuuc88UCxsrs6vw6kQfio+08rLVTzp1 PqKr8+t0pcbADn9LLwzLk5UKI7eoLnfZvtiktSKpzF68SYZDXDIZjG AJnY21t6 18z14/ sioMDCZZIU2nmmRdkRVG9Q6xe5gY/ TfJw5+vI8LfcNU52PJNeH4XM0AnmG kaDQZdpM2rsep9t57sh15JxRXPuYrJZkL6Z/zMZA6FQJpE1kraVT1oCYNiyQQRzB MH07pC0gJdw4hB6gElwku3J/RnnFNpvudRRHJHBK9i6kMEFbjGyHdt31BdvsDEw= -----END CERTIFICATE----- </pre>

Note:

1. Please setup the **System Maintenance >> Time and Date** correctly before you try to regenerate a self-signed certificate!!
2. The Time Zone MUST be setup correctly!!

Regenerate

Click Regeneration to open Regenerate Self-Signed Certificate window. Enter all the information that the window request such as certificate name (used for identifying different certificate), subject alternative name type and relational settings for subject name. Then click GENERATE.

Regenerate Self-Signed Certificate

Certificate Name	self-signed
Subject Alternative Name	
Type	IP Address ▾
IP	<input type="text"/>
Domain Name	<input type="text"/>
E-Mail	<input type="text"/>
Subject Name	
Country (C)	<input type="text"/>
State (ST)	<input type="text"/>
Location (L)	<input type="text"/>
Organization (O)	<input type="text"/>
Organization Unit (OU)	<input type="text"/>
Common Name (CN)	<input type="text"/>
Email (E)	<input type="text"/>
Key Type	RSA ▾
Key Size	2048 Bit ▾

VI-1-12 Reboot System

The Web user interface may be used to restart your router. Click **Reboot System** from **System Maintenance** to open the following page.

System Maintenance >> Reboot System

Reboot System

Do you want to reboot your router ?

Using current configuration
 Using factory default configuration

Auto Reboot Time Schedule

Schedule Profile : , , ,

Note: Action and Idle Timeout settings will be ignored.

Schedule Profile - You can Enter four sets of time schedule for performing system reboot. All the schedules can be set previously in **Applications >> Schedule** web page and you can use the number that you have set in that web page.

If you want to reboot the router using the current configuration, check **Using current configuration** and click **Reboot Now**. To reset the router settings to default values, check **Using factory default configuration** and click **Reboot Now**. The router will take 5 seconds to reboot the system.



Info

When the system pops up Reboot System web page after you configure web settings, please click Reboot Now to reboot your router for ensuring normal operation and preventing unexpected errors of the router in the future.

VI-1-13 Firmware Upgrade

Click System Maintenance>> Firmware Upgrade to proceed to firmware upgrade.

System Maintenance >> Firmware Upgrade



Web Firmware Upgrade

Select a firmware file.

未選擇任何檔案

Click Upgrade to upload the file.

TFTP Firmware Upgrade from LAN

Current Firmware Version: 3.8.12_RC2

Firmware Upgrade Procedures:

1. Click "OK" to start the TFTP server.
2. Open the Firmware Upgrade Utility or other 3-party TFTP client software.
3. Check that the firmware filename is correct.
4. Click "Upgrade" on the Firmware Upgrade Utility to start the upgrade.
5. After the upgrade is complete, the TFTP server will automatically stop running.

Do you want to upgrade firmware ?

Note:

Upgrade using the ALL file will retain existing router configuration, whereas using the RST file will reset the configuration to factory defaults.

Click Select to specify the one you just download. After choosing the file you want, click Upgrade. The system will upgrade the firmware of the router automatically.

VI-1-14 Activation

There are three ways to activate WCF on vigor router, using **Service Activation Wizard**, by means of **CSM>>Web Content Filter Profile** or via **System Maintenance>>Activation**.

After you have finished the setting profiles for WCF (refer to **Web Content Filter Profile**), it is the time to activate the mechanism for your computer.

Click **System Maintenance>>Activation** to open the following page for accessing <http://myvigor.draytek.com>.

System Maintenance >> Activation **Activate via interface :** auto-selected ▼

Web-Filter License **Activate**
[Status: **Not Activated**]

Authentication Message

Note:

1. If you want to use email alert or syslog, please configure the [SysLog/Mail Alert Setup](#) page.
2. If you change the service provider, the configuration of the function will be reset.

Available settings are explained as follows:

Item	Description
Activate via Interface	Choose WAN interface used by such device for activating Web Content Filter.
Activate	The Activate link brings you accessing into www.vigorpro.com to finish the activation of the account and the router.
Authentication Message	As for authentication information of web filter, the process of authenticating will be displayed on this field for your reference.

Below shows the successful activation of Web Content Filter:

System Maintenance >> Activation

Activate via interface:

Web-Filter License

[Activate](#)

[Status: **Commtouch**] [Start Date: **2011-03-28** Expire Date: **2011-04-27**]

```
Authentication Message
WebFilter, Activation authenticate fail, contact with support@draytek.com, 20
01 00:00:24
```

Note: If you want to use email alert or syslog, please configure the [SysLog/Mail Alert Setup](#) page.

If you change the service provider, the configuration of the function will be reset.

VI-2 Bandwidth Management

Sessions Limit

A PC with private IP address can access to the Internet via NAT router. The router will generate the records of NAT sessions for such connection. The P2P (Peer to Peer) applications (e.g., BitTorrent) always need many sessions for procession and also they will occupy over resources which might result in important accesses impacted. To solve the problem, you can use limit session to limit the session procession for specified Hosts.

Bandwidth Limit

The downstream or upstream from FTP, HTTP or some P2P applications will occupy large of bandwidth and affect the applications for other programs. Please use Limit Bandwidth to make the bandwidth usage more efficient.

Quality of Service (QoS)

Deploying QoS (Quality of Service) management to guarantee that all applications receive the service levels required and sufficient bandwidth to meet performance expectations is indeed one important aspect of modern enterprise network.

One reason for QoS is that numerous TCP-based applications tend to continually increase their transmission rate and consume all available bandwidth, which is called TCP slow start. If other applications are not protected by QoS, it will detract much from their performance in the overcrowded network. This is especially essential to those are low tolerant of loss, delay or jitter (delay variation).

Another reason is due to congestions at network intersections where speeds of interconnected circuits mismatch or traffic aggregates, packets will queue up and traffic can be throttled back to a lower speed. If there's no defined priority to specify which packets should be discarded (or in another term "dropped") from an overflowing queue, packets of sensitive applications mentioned above might be the ones to drop off. How this will affect application performance?

There are two components within Primary configuration of QoS deployment:

- Classification: Identifying low-latency or crucial applications and marking them for high-priority service level enforcement throughout the network.
- Scheduling: Based on classification of service level to assign packets to queues and associated service types

The basic QoS implementation in Vigor routers is to classify and schedule packets based on the service Entertormation in the IP header. For instance, to ensure the connection with the headquarter, a teleworker may enforce an index of QoS Control to reserve bandwidth for HTTPS connection while using lots of application at the same time.

One more larger-scale implementation of QoS network is to apply DSCP (Differentiated Service Code Point) and IP Precedence disciplines at Layer 3. Compared with legacy IP Precedence that uses Type of Service (ToS) field in the IP header to define 8 service classes, DSCP is a successor creating 64 classes possible with backward IP Precedence compatibility. In a QoS-enabled network, or Differentiated Service (DiffServ or DS) framework, a DS domain owner should sign a Service License Agreement (SLA) with other DS domain owners to define the service level provided toward traffic from different domains. Then each DS node in these domains will perform the priority treatment. This is called per-hop-behavior (PHB). The definition of PHB includes Expedited Forwarding (EF), Assured Forwarding (AF), and Best Effort (BE). AF defines the four classes of delivery (or forwarding) classes and three levels of drop precedence in each class.

Vigor routers as edge routers of DS domain shall check the marked DSCP value in the IP header of bypassing traffic, to allocate certain amount of resource execute appropriate policing, classification or scheduling. The core routers in the backbone will do the same checking before executing treatments in order to ensure service-level consistency throughout the whole QoS-enabled network.

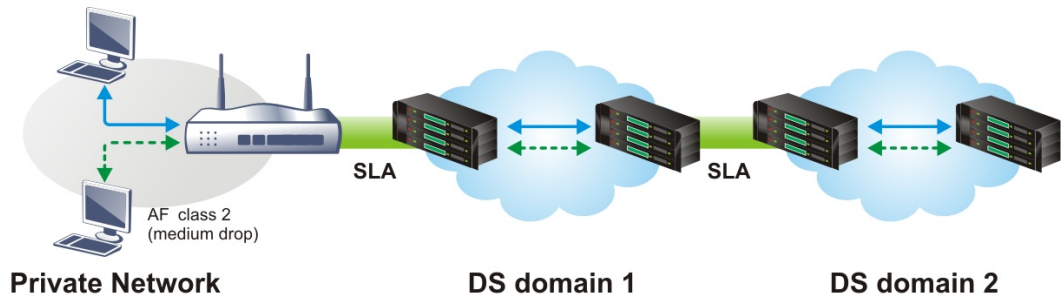

However, each node may take different attitude toward packets with high priority marking since it may bind with the business deal of SLA among different DS domain owners. It's not easy to achieve deterministic and consistent high-priority QoS traffic throughout the whole network with merely Vigor router's effort.

Web User Interface

Below shows the menu items for Bandwidth Management.

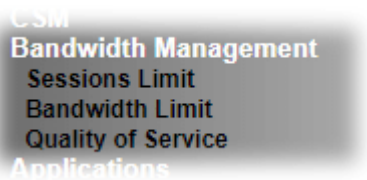

VI-2-1 Sessions Limit

In the Bandwidth Management menu, click Sessions Limit to open the web page.

Bandwidth Management >> Sessions Limit

IPv4
IPv6

Enable Disable

Default Max Sessions:

Limitation List

Index	Start IP	End IP	Max Sessions

Specific Limitation

Start IP: End IP:

Maximum Sessions:

Administration Message (Max 255 characters)

You have reached the maximum number of permitted Internet sessions.<p>Please close one or more applications to allow further Internet access.<p>Contact your system administrator for further information.

Time Schedule

Schedule Profile : , , ,

Note: Action and Idle Timeout settings will be ignored.

To activate the function of limit session for IPv4 and/or IPv6, simply click **Enable** and set the default session limit.

Available settings are explained as follows:

Item	Description
Session Limit	<p>Enable - Click this button to activate the function of limit session.</p> <p>Disable - Click this button to close the function of limit session.</p> <p>Default Max Sessions - Defines the default session number used for each computer in LAN.</p>

Limitation List	Displays a list of specific limitations that you set on this web page.
Specific Limitation	<p>Start IP - Defines the start IP address for limit session.</p> <p>End IP - Defines the end IP address for limit session.</p> <p>Maximum Sessions - Defines the available session number for each host in the specific range of IP addresses. If you do not set the session number in this field, the system will use the default session limit for the specific limitation you set for each index.</p> <p>Add - Adds the specific session limitation onto the list above.</p> <p>Edit - Allows you to edit the settings for the selected limitation.</p> <p>Delete - Remove the selected settings existing on the limitation list.</p>
Administration Message	<p>Enter the words which will be displayed when reaches the maximum number of Internet sessions permitted.</p> <p>Default Message - Click this button to apply the default message offered by the router.</p>
Time Schedule	<p>Schedule Profile - You can Enter four sets of time schedule for your request. All the schedules can be set previously in Application >> Schedule web page and you can use the number that you have set in that web page.</p>

After finishing all the settings, please click **OK** to save the configuration.

VI-2-2 Bandwidth Limit

In the Bandwidth Management menu, click **Bandwidth Limit** to open the web page.

Bandwidth Management >> Bandwidth Limit

IPv4
IPv6

Enable
 IP Routed Subnet
 Disable

Default TX Limit Per User: Kbps
 Default RX Limit Per User: Kbps

Limitation List (Max. 10 entries)

Index	Start IP/Group	End IP/Object	TX limit	RX limit	Share

Specific Limitation
 IP
 Object

Start IP: End IP:

Each
 Shared
 TX Limit: Kbps
 RX Limit: Kbps

Allow auto adjustment to assign available bandwidth equally to active user.
 Smart Bandwidth Limit

For any LAN IP Not in Limitation List, whose session number exceeds

TX Limit : Kbps
 RX Limit : Kbps

Note:

- For TX/RX, a setting of "0" means unlimited bandwidth.
- Available bandwidth is calculated according to the maximum bandwidth detected or the Line Speed defined in WAN >> **General Setup** when in "According to Line Speed" Load Balance mode.

Time Schedule

Schedule Profile : , , ,

Note: Action and Idle Timeout settings will be ignored.

To activate the function of limit bandwidth for IPv4 and /or IPv6, simply click **Enable** and set the default upstream and downstream limit.

Available settings are explained as follows:

Item	Description
Bandwidth Limit	<p>Enable - Click this button to activate the function of limit bandwidth.</p> <p>IP Routed Subnet - Check this box to apply the bandwidth limit to the second subnet specified in LAN>>General Setup. It is available for IPv4 settings only.</p> <p>Disable - Click this button to close the function of limit bandwidth.</p> <p>Default TX limit Per User- Define the default speed of the upstream for each computer in LAN.</p> <p>Default RX limit Per User- Define the default speed of the downstream for each computer in LAN.</p>
Limitation List	Display a list of specific limitations that you set on this web page.

<p>Specific Limitation</p>	<p>Start IP - Define the start IP address for limit bandwidth.</p> <p>End IP - Define the end IP address for limit bandwidth.</p> <p>Each /Shared - Select Each to make each IP within the range of Start IP and End IP having the same speed defined in TX limit and RX limit fields; select Shared to make all the IPs within the range of Start IP and End IP share the speed defined in TX limit and RX limit fields.</p> <p>TX limit - Define the limitation for the speed of the upstream. If you do not set the limit in this field, the system will use the default speed for the specific limitation you set for each index.</p> <p>RX limit - Define the limitation for the speed of the downstream. If you do not set the limit in this field, the system will use the default speed for the specific limitation you set for each index.</p> <p>Add - Add the specific speed limitation onto the list above.</p> <p>Edit - Allow you to edit the settings for the selected limitation.</p> <p>Delete - Remove the selected settings existing on the limitation list.</p>
<p>Allow auto adjustment...</p>	<p>Check this box to make the best utilization of available bandwidth.</p>
<p>Smart Bandwidth Limit</p>	<p>Check this box to have the bandwidth limit determined by the system automatically.</p> <p>TX limit - Define the limitation for the speed of the upstream. If you do not set the limit in this field, the system will use the default speed for the specific limitation you set for each index.</p> <p>RX limit - Define the limitation for the speed of the downstream. If you do not set the limit in this field, the system will use the default speed for the specific limitation you set for each index.</p>
<p>Time Schedule</p>	<p>Schedule Profile - You can Enter four sets of time schedule for your request. All the schedules can be set previously in Applications >> Schedule web page and you can use the number that you have set in that web page.</p>

VI-2-3 Quality of Service

In the Bandwidth Management menu, click **Quality of Service** to open the web page.

Bandwidth Management >> Quality of Service

[Set to Factory Default](#)

Index	Enable	Direction	Inbound/ Outbound Bandwidth		Class 1	Class 2	Class 3	Others	Status		
WAN2	<input type="checkbox"/>	BOTH	100	Mbps	100	Mbps	25%	25%	25%	25%	Status
LTE	<input type="checkbox"/>	BOTH	100	Mbps	100	Mbps	25%	25%	25%	25%	Status

Note: QoS may not work properly if the bandwidth entered is not correct. Before enable QoS, you may run speed test (from e.g., <http://speedtest.net>) or contact your ISP for the accurate bandwidth.

Index	Name	Rule	Service Type
Class 1		Edit	
Class 2		Edit	Edit
Class 3		Edit	

Available settings are explained as follows:

Item	Description
General Setup	<p>Index - Display the WAN interface number link that you can edit.</p> <p>Enable - Check the box to enable the QoS function for WAN interface. If it is enabled, you can configure general QoS setting for each WAN interface.</p> <ul style="list-style-type: none"> ● Direction - Define which traffic the QoS Control settings will apply to. <ul style="list-style-type: none"> ■ IN- apply to incoming traffic only. ■ OUT-apply to outgoing traffic only. ■ BOTH- apply to both incoming and outgoing traffic. ● Inbound/Outbound Bandwidth - Set the connecting rate of data input/output for other WAN. For example, if your ADSL supports 1M of downstream and 256K upstream, please set 1000kbps for this box. The default value is 10000kbps. ● Class 1 ~ 3 / Others - Define the ratio of bandwidth to upstream speed and bandwidth to downstream speed. There are four queues allowed for QoS control. The first three (Class 1 to Class 3) class rules can be adjusted for your necessity. In which, the "Others" field is used for the packets which are not suitable for the three class rules. <p>Status - Display the online statistics of WAN interface.</p>
Class Rule	<p>Index - Display the class number that you can edit.</p> <p>Name - Display the name of the class.</p> <p>Rule - Allow to configure detailed settings for the selected Class.</p> <p>Service Type - Allow to configure detailed settings for the service type.</p>

Click the **WAN2/LTE** link to access into next page for the general setup of WAN interface. As to class rule, simply click the **Edit** link to access into next for configuration.

You can configure general setup for the WAN interface, edit the Class Rule, and edit the Service Type for the Class Rule for your request.

Online Statistics

Click the **WAN2/LTE** link to access into next page for the general setup of WAN interface. As to class rule, simply click the **Edit** link to access into next for configuration.

Bandwidth Management >> Quality of Service

WAN2 Online Statistics Refresh Interval: 5 seconds | [Refresh](#)

Index	Direction	Class Name	Reserved-bandwidth Ratio	Inbound Throughput (bps)	Outbound Throughput (bps)
1	BOTH		25%	0	0
2	BOTH		25%	0	0
3	BOTH		25%	0	0
4	BOTH	Others	25%	0	0

Inbound Status

Others

Outbound Status

Others

General Setup for WAN Interface

Click WAN interface number link to configure the limited bandwidth ratio for QoS of the WAN interface.

Bandwidth Management >> Quality of Service >> WAN1

Enable UDP Bandwidth Control
 Limited_bandwidth Ratio %
 Outbound TCP ACK Prioritize

Available settings are explained as follows:

Item	Description
Enable UDP Bandwidth Control	Set the limited bandwidth ratio. This is a protection of TCP application traffic since UDP application traffic such as streaming video will exhaust lots of bandwidth. Limited_bandwidth Ratio - The ratio typed here is reserved for limited bandwidth of UDP application.
Outbound TCP ACK Prioritize	The difference in bandwidth between download and upload are great in ADSL2+ environment. For the download speed might be impacted by the uploading TCP ACK, you can check this box to push ACK of upload faster to speed the network traffic.



Info

The rate of outbound/inbound must be smaller than the real bandwidth to ensure correct calculation of QoS. It is suggested to set the bandwidth value for inbound/outbound as 80% - 85% of physical network speed provided by ISP to maximize the QoS performance.

Edit the Class Rule for QoS

- The first three (Class 1 to Class 3) class rules can be adjusted for your necessity. To add, edit or delete the class rule, please click the **Edit** link of that one.

Bandwidth Management >> Quality of Service

[Set to Factory Default](#)

General Setup	Index	Enable	Direction	Inbound/ Outbound Bandwidth		Class 1	Class 2	Class 3	Others	Status	
WAN2	<input type="checkbox"/>	BOTH ▾	100	Mbps ▾ /	100	Mbps ▾	25 %	25 %	25 %	25 %	Status
LTE	<input type="checkbox"/>	BOTH ▾	100	Mbps ▾ /	100	Mbps ▾	25 %	25 %	25 %	25 %	Status

Note: QoS may not work properly if the bandwidth entered is not correct. Before enable QoS, you may run speed test (from e.g., <http://speedtest.net>) or contact your ISP for the accurate bandwidth.

Class Rule

Index	Name	Rule	Service Type
Class 1		Edit	Edit
Class 2		Edit	
Class 3		Edit	

- After you click the **Edit** link, you will see the following page. Now you can define the name for that Class. In this case, "Test" is used as the name of Class Index #1.

Bandwidth Management >> Quality of Service

Class Index #1

Name Tag Outbound Packets as:

NO	Status	Local Address	Remote Address	DiffServ CodePoint	Service Type
1	Empty	-	-	-	-

- For adding a new rule, click **Add** to open the following page.

Bandwidth Management >> Quality of Service

Rule Edit

Enable

Ethernet Type IPv4 IPv6

Local Address

Remote Address

DiffServ CodePoint

Service Type

Note:
Please choose/setup the **Service Type** first.

Available settings are explained as follows:

Item	Description
Enable	Check this box to invoke these settings.
Ethernet Type	Please specify which protocol (IPv4 or IPv6) will be used for this rule.
Local Address	Click the Edit button to set the local IP address (on LAN) for the rule.

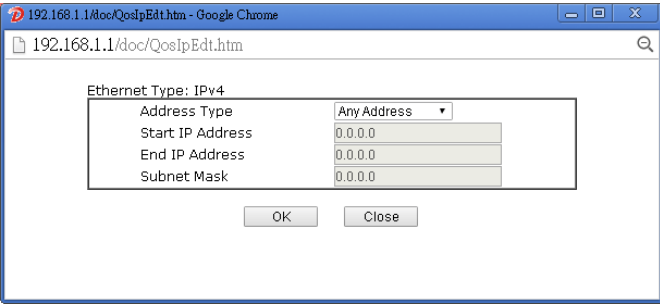
Remote Address	<p>Click the Edit button to set the remote IP address (on LAN/WAN) for the rule.</p>  <p>Address Type - Determine the address type for the source address.</p> <p>For Single Address, you have to fill in Start IP address.</p> <p>For Range Address, you have to fill in Start IP address and End IP address.</p> <p>For Subnet Address, you have to fill in Start IP address and Subnet Mask.</p>
DiffServ CodePoint	<p>All the packets of data will be divided with different levels and will be processed according to the level type by the system. Please assign one of the levels of the data for processing with QoS control.</p>
Service Type	<p>It determines the service type of the data for processing with QoS control. It can also be edited. You can choose the predefined service type from the Service Type drop down list. Those types are predefined in factory. Simply choose the one that you want for using by current QoS.</p>

4. After finishing all the settings here, please click **OK** to save the configuration.

By the way, you can set up to 20 rules for one Class. If you want to edit an existed rule, please select the radio button of that one and click **Edit** to open the rule edit page for modification.

Bandwidth Management >> Quality of Service

Class Index #1

Name Tag Outbound Packets as:

NO	Status	Local Address	Remote Address	DiffServ CodePoint	Service Type
1 <input type="radio"/>	Active	Any	Any	ANY	ANY

Edit the Service Type for Class Rule

- To add a new service type, edit or delete an existed service type, please click the Edit link under Service Type field.

Bandwidth Management >> Quality of Service

General Setup [Set to Factory Default](#)

Index	Enable	Direction	Inbound/ Outbound Bandwidth		Class 1	Class 2	Class 3	Others	Status	
WAN2	<input type="checkbox"/>	BOTH	100	Mbps	100	Mbps	25%	25%	25%	Status
LTE	<input type="checkbox"/>	BOTH	100	Mbps	100	Mbps	25%	25%	25%	Status

Note: QoS may not work properly if the bandwidth entered is not correct. Before enable QoS, you may run speed test (from e.g., <http://speedtest.net>) or contact your ISP for the accurate bandwidth.

Class Rule

Index	Name	Rule	Service Type
Class 1		Edit	
Class 2		Edit	Edit
Class 3		Edit	

- After you click the Edit link, you will see the following page.

Bandwidth Management >> Quality of Service

User Defined Service Type

NO	Name	Protocol	Port
1	Empty	-	-

- For adding a new service type, click **Add** to open the following page.

Bandwidth Management >> Quality of Service

Service Type Edit

Service Name	<input type="text"/>
Service Type	TCP <input type="text" value="6"/>
Port Configuration	<input checked="" type="radio"/> Single <input type="radio"/> Range
Port Number	<input type="text" value="0"/> - <input type="text" value="0"/>

Available settings are explained as follows:

Item	Description
Service Name	Enter a new service for your request. The maximum length of the name you can set is 11 characters.
Service Type	Choose the type (TCP, UDP or TCP/UDP or other) for the new service.
Port Configuration	<p>Type - Click Single or Range as the Type. If you select Range, you have to Enter the starting port number and the end porting number on the boxes below.</p> <p>Port Number - Enter the starting port number and the end porting number here if you choose Range as the type.</p>

- After finishing all the settings here, please click **OK** to save the configuration.

By the way, you can set up to 10 service types. If you want to edit/delete an existed service type, please select the radio button of that one and click **Edit/Edit** for modification.

Retag the Packets for Identification

Packets coming from LAN IP can be retagged through QoS setting. When the packets sent out through WAN interface, all of them will be tagged with certain header and that will be easily to be identified by server on ISP.

For example, in the following illustration, the VoIP packets in LAN go into Vigor router without any header. However, when they go forward to the Server on ISP through Vigor router, all of the packets are tagged with AF (configured in Bandwidth >>QoS>>Class) automatically.

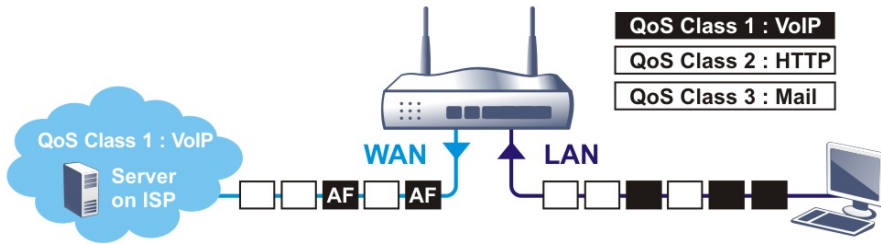

Bandwidth Management >> Quality of Service

Class Index #1

Name VoIP

Tag Outbound Packets as: AF Class1 (High Drop)

NO	Status	Local Address	Remote Address	DiffServ CodePoint	Service Type
1	<input type="radio"/> Active	Any	Any	ANY	ANY

Add Edit Delete

OK Cancel

Application Notes

A-1 How to Optimize the Bandwidth through QoS Technology

Have you ever gotten any problems in uploading/downloading files (Voice, video or email/data only) with the narrow/districted bandwidth you may share from the common Internet connection line? The advanced bandwidth management technology-QoS (Quality of Service) helps you to well allocate the bandwidth upon your demand of Voice, Video, or Data transferring. Let's see how to get the optimum bandwidth per your request by using DrayTek Vigor router as below.

Scenario: The Internet connection you got from ISP line is 2MB/512Kb. There are VoIP telephony network, IPTV set top box and data server at your home. Assume you want to allocate 30% of the bandwidth you got to VoIP demand, 50% for IPTV, 15% for mail/data, 5% for others. Let's see how easily it is to do the setting as below:

1. Open **Bandwidth Management >> Quality of Service**.
2. You will get the following page. Click the **Edit** link for **Class 1**.

Bandwidth Management >> Quality of Service

General Setup										Set to Factory Default		
Index	Enable	Direction	Inbound/		Outbound Bandwidth		Class 1	Class 2	Class 3	Others	Status	
WAN2	<input type="checkbox"/>	BOTH	100	Mbps	/	100	Mbps	25 %	25 %	25 %	25 %	Status
LTE	<input type="checkbox"/>	BOTH	100	Mbps	/	100	Mbps	25 %	25 %	25 %	25 %	Status

Note: QoS may not work properly if the bandwidth entered is not correct. Before enable QoS, you may run speed test (from e.g., <http://speedtest.net>) or contact your ISP for the accurate bandwidth.

Class Rule

Index	Name	Rule	Service Type
Class 1		Edit	
Class 2		Edit	Edit
Class 3		Edit	

3. In the following page, type a name (e.g., VoIP) for such class and click **Add**.

Bandwidth Management >> Quality of Service

Class Index #1

Name	<input type="text" value="VoIP"/>	<input type="checkbox"/> Tag Outbound Packets as:	Default		
NO	Status	Local Address	Remote Address	DiffServ CodePoint	Service Type
1	Empty	-	-	-	-

4. Check the box of **ACT**. Click **Edit** to specify the local address.

Bandwidth Management >> Quality of Service

Rule Edit

<input checked="" type="checkbox"/> ACT	<input type="checkbox"/> Hardware Acceleration
Ethernet Type	<input checked="" type="radio"/> IPv4 <input type="radio"/> IPv6
Local Address	Any <input type="button" value="Edit"/>
Remote Address	Any <input type="button" value="Edit"/>
DiffServ CodePoint	ANY
Service Type	---Predefined---

Note:
Please choose/setup the **Service Type** first.

- In the pop-up window, choose **Range Address** as the **Address Type** and Enter the start IP address and end IP address in relational fields. Click **OK** to save the settings and exit the window.

192.168.1.1/doc/QosIpEdt.htm - Google Chrome

192.168.1.1/doc/QosIpEdt.htm

Ethernet Type: IPv4

Address Type	Range Address
Start IP Address	172.16.1.240
End IP Address	172.16.1.241
Subnet Mask	0.0.0.0

- Click **OK** again to save the settings.

Bandwidth Management >> Quality of Service

Rule Edit

<input checked="" type="checkbox"/> Enable	
Ethernet Type	<input checked="" type="radio"/> IPv4 <input type="radio"/> IPv6
Local Address	172.16.2.240~172.16.2.241 <input type="button" value="Edit"/>
Remote Address	Any <input type="button" value="Edit"/>
DiffServ CodePoint	ANY
Service Type	---Predefined---

Note:
Please choose/setup the **Service Type** first.

7. The class rule for VoIP has been set. Click OK to return to previous page.

Bandwidth Management >> Quality of Service

Class Index #1

Name Tag Outbound Packets as:

NO	Status	Local Address	Remote Address	DiffServ CodePoint	Service Type
1 <input type="radio"/>	Active	172.16.1.240 ~ 172.16.1.241	Any	ANY	ANY

8. Do the same steps to add class rules for IPTV and Data/Email with IP addresses as shown below.

Bandwidth Management >> Quality of Service

Class Index #2

Name Tag Outbound Packets as:

NO	Status	Local Address	Remote Address	DiffServ CodePoint	Service Type
1 <input type="radio"/>	Inactive	Any	Any	ANY	undefined
2 <input type="radio"/>	Active	172.16.1.242 ~ 172.16.1.249	Any	ANY	ANY

and

Bandwidth Management >> Quality of Service

Class Index #3

Name Tag Outbound Packets as:

NO	Status	Local Address	Remote Address	DiffServ CodePoint	Service Type
1 <input type="radio"/>	Active	Any	Any	IP precedence 2	DNS(TCP/UDP:53)

9. Assuming you get 2MB/512Kb Internet line. You can check Enable of WAN1 to set up the bandwidth for different groups among VoIP, IPTV and Data/Email.

Bandwidth Management >> Quality of Service

General Setup [Set to Factory Default](#)

Index	Enable	Direction	Inbound/ Outbound Bandwidth		Class 1	Class 2	Class 3	Others	Status
WAN1	<input checked="" type="checkbox"/>	BOTH	--Kbps/	--Kbps	25 %	25 %	25 %	25 %	Status
WAN2	<input type="checkbox"/>	BOTH	100 Mbps	100 Mbps	25 %	25 %	25 %	25 %	Status
LTE	<input type="checkbox"/>	BOTH	100 Mbps	100 Mbps	25 %	25 %	25 %	25 %	Status

Note: QoS may not work properly if the bandwidth entered is not correct. Before enable QoS, you may run speed test (from e.g., <http://speedtest.net>) or contact your ISP for the accurate bandwidth.

Class Rule

Index	Name	Rule	Service Type
Class 1	VoIP	Edit	
Class 2	IPTV	Edit	Edit
Class 3	Data/Email	Edit	

- Enter 30, 50 and 15 in the boxes for VoIP, IPTV and Data/Email respectively.

Bandwidth Management >> Quality of Service

General Setup [Set to Factory Default](#)

Index	Enable	Direction	Inbound/ Outbound Bandwidth		Class 1	Class 2	Class 3	Others	Status
WAN1	<input checked="" type="checkbox"/>	BOTH ▾	--Kbps/	--Kbps	30 %	50 %	15 %	30 %	Status
WAN2	<input type="checkbox"/>	BOTH ▾	100 Mbps ▾ /	100 Mbps ▾	25 %	25 %	25 %	25 %	Status
LTE	<input type="checkbox"/>	BOTH ▾	100 Mbps ▾ /	100 Mbps ▾	25 %	25 %	25 %	25 %	Status

Note: QoS may not work properly if the bandwidth entered is not correct. Before enable QoS, you may run speed test (from e.g.,http://speedtest.net) or contact your ISP for the accurate bandwidth.

Class Rule

Index	Name	Rule	Service Type
Class 1	VoIP	Edit	Edit
Class 2	IPTV	Edit	
Class 3	Data/Email	Edit	

- Click the WAN1 link and check the box of Enable UDP Bandwidth Control.

Bandwidth Management >> Quality of Service >> WAN1

Enable UDP Bandwidth Control
 Limited_bandwidth Ratio %

Outbound TCP ACK Prioritize

- Click OK to save the settings.

VI-3 Central Management (AP)

VigorLTE 200 can manage the access points supporting AP management via Central AP Management.

AP Map

AP Map is helpful to determine the best location for VigorAP in a room. A floor plan of a room is required to be uploaded first. By dragging and dropping available VigorAP icon from the list to the floor plan, the placement with the best wireless coverage will be clearly indicated through simulated signal strength

AP Maintenance

Vigor router can execute configuration backup, configuration restoration, firmware upgrade and remote reboot for the APs managed by the router. It is very convenient for the administrator to process maintenance without accessing into the web user interface of the access point.

Load Balance for AP

The parameters configured for Load Balance can help to distribute the traffic for all of the access points registered to Vigor router. Thus, the bandwidth will not be occupied by certain access points.

AP Load Balance (Traffic overload)

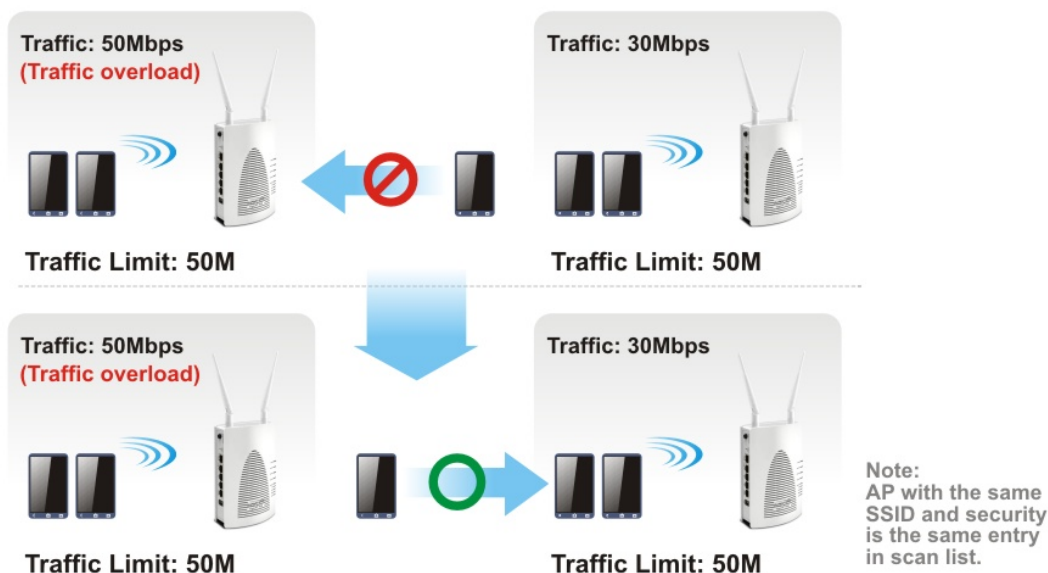

Web User Interface

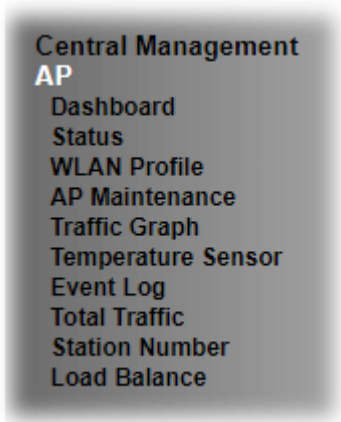

VI-3-1 Dashboard

This page shows VigorAP's information about Status, Event Log, Total Traffic or Station Number by displaying VigorAP icon, text and histogram. Just move and click your mouse cursor on Status, Event Log, Total Traffic or Station Number. Corresponding web pages will be open immediately.

Central AP Management >> Dashboard

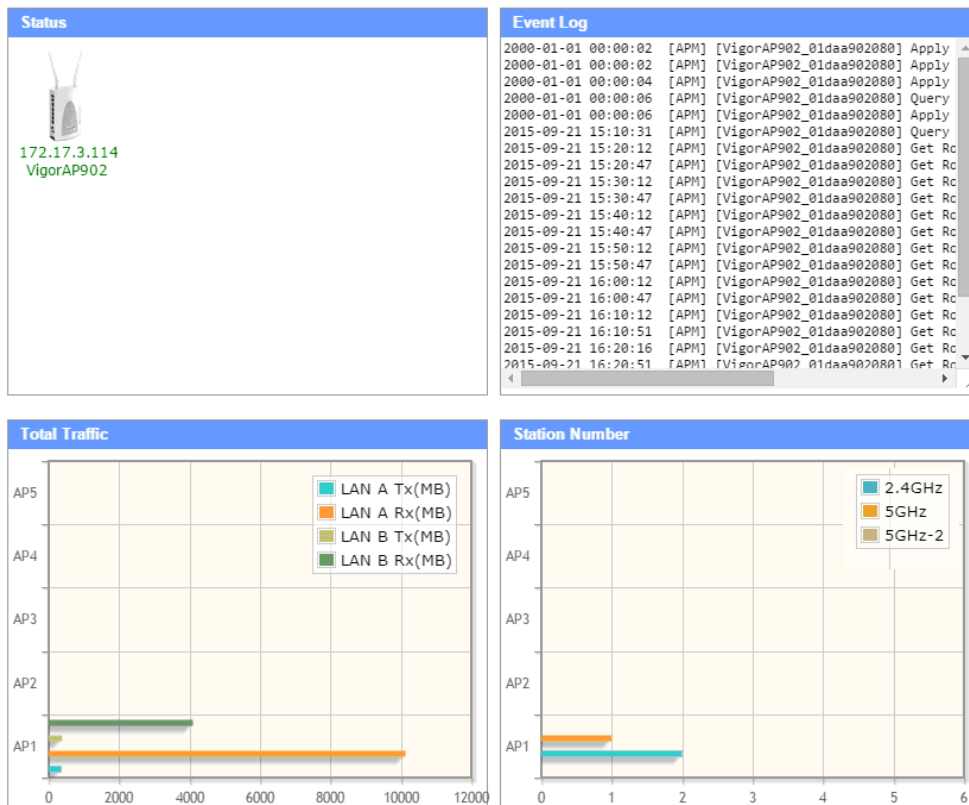

AP1-- IP:172.17.3.114 Device Name:VigorAP902

AP1-- IP:172.17.3.114 Device Name:VigorAP902

Note: Only browser supporting [HTML5](#) can display dashboard correctly.

To access into the web user interface of VigorAP, simply move your mouse cursor on the VigorAP icon and click it. The system will guide you to access into the web user interface of VigorAP.

VI-3-2 Status

This page displays current status (online, offline or SSID hidden, IP address, encryption, channel, version, password and etc.) of the access points managed by Vigor router. Please open **Central AP Management>>Function Support List** to check what AP Models are supported.

Central Management >> AP >> Status

Index	Device Name	IP Address	SSID	Ch.	STA List	AP List	Uptime	Ver.	Password
-------	-------------	------------	------	-----	----------	---------	--------	------	----------

| [Clear](#) | [Refresh](#) |

Note:

 : Online  : Offline  : Hidden SSID

Maximum support 2 APs.

When AP Devices connect via an intermediary switch, please ensure that **UDP:4944** port and the **HTTP** port of AP Devices are not blocked so that the AP status can be retrieved.

Available settings are explained as follows:

Item	Description
Index	Click the index number link for viewing the settings summary of the access point.
Device Name	The name of the AP managed by Vigor router will be displayed here.
IP Address	Display the true IP address of the access point.
SSID	Display the SSID configured for the access point(s) connected to VigorLTE 200.
Ch.	Display the channel used by the access point.
STA List	Display the number of wireless clients (stations) connecting to the access point. In which, 0/64 means that up to 64 clients are allowed to connect to the access point. But, now no one connects to the access point. The number displayed on the left side means 2.4GHz; and the number displayed on the right side means 5GHz.
AP List	Display the number of the AP around the device.
Uptime	Display the duration of the AP powered up.
Version	Display the firmware version used by the access point.
Password	VigorLTE 200 can get related information of the access point by accessing into the web user interface of the access point. This button is used to modify the logging password of the connected access point.

VI-3-3 WLAN Profile

WLAN profile is used to apply to a selected access point. It is very convenient for the administrator to configure the setting for access point without opening the web user interface of the access point.

Central Management >> AP >> WLAN Profile

Profile	Name	Main SSID	Security	Multi-SSID	WLAN ACL	Rate Ctrl	Clone	To AP	To Local
1	Default	DrayTek-LAN-A	WPA+WPA2/PSK	Enable	None	None			
2	---	---	---	---	---	---	---	---	---
3	---	---	---	---	---	---	---	---	---
4	---	---	---	---	---	---	---	---	---
5	---	---	---	---	---	---	---	---	---

Click the number link of the selected profile to modify the content of the profile. Available settings are explained as follows:

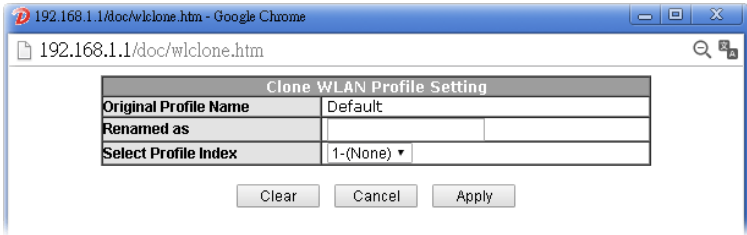
Item	Description
Profile	There are five WLAN profiles offered to be configured. Simply click the index number link to open the modification page.
Name	Display the name of the profile. The default profile cannot be renamed.
Main SSID	Display the SSID configured by such wireless profile.
Security	Display the security mode selected by such wireless profile.
Multi-SSID	Enable means multiple SSIDs (more than one) are active. Disable means only SSID1 is active.
WLAN ACL	Display the name of the access control list.
Rate Ctrl	Display the upload and/or download transmission rate.
Clone	<p>It can copy settings from an existing WLAN profile to another WLAN profile.</p> <p>First, you have to check the box of the existing profile as the original profile. Second, click Clone. The following dialog will appear.</p>  <p>Third, choose the profile index to accept the settings from the original profile. Forth, type a new name in the field of Renamed as. Last, click Apply to save the settings on this dialog.</p> <p>The new profile has been created with the settings coming from the original profile.</p>
To AP	Click it to apply the selected wireless profile to the specified Access Point.

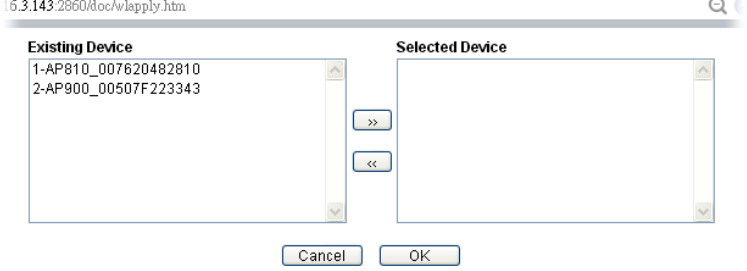
	 <p>Simply choose the device you want from Existing Device field. Click >> to move the device to Selected Device field. Then, click OK.</p> <p>The selected WLAN profile will be applied to the selected access point immediately. Later the access point will reboot.</p>
<p>To Local</p>	<p>WLAN Profile configured in this page is specified for VigorAP connected to Vigor router.</p> <p>If required, these settings also can be applied to Vigor router. Select and check one of wireless profiles and click this button to apply the settings onto the WI-Fi wireless settings configured for such Vigor router.</p>

How to edit the wireless LAN profile?

1. Select the WLAN profile (index number 1 to 5) you want to edit.
2. Click the index number link to display the following page.

Central Management >> AP >> WLAN Profile

WLAN Profile Edit

Device Settings	
Profile Name	Default <input type="checkbox"/> Auto Provision
Administrator	admin
Password
2nd Subnet	<input checked="" type="radio"/> Enable <input type="radio"/> Disable
Management VLAN	<input type="checkbox"/> Enable Management VLAN: LAN-A VLAN ID <input type="text" value="0"/> (0 ~ 4095) LAN-B VLAN ID <input type="text" value="0"/> (0 ~ 4095)

WLAN General Setting

	2.4GHz	5GHz	5GHz-2
Wireless LAN	<input checked="" type="radio"/> Enable <input type="radio"/> Disable		
Limit Client	<input type="checkbox"/> Enable <input type="text" value="64"/> (3 ~ 128, default: 64)		
Operation Mode	AP ▼		
2.4G Mode	Mixed(11b+11g+11n) ▼		
2.4G Channel	2462MHz (Channel 11) ▼		
Airtime Fairness	<input type="checkbox"/> Enable Airtime Fairness: Triggering Client Number <input type="text" value="2"/> (2 ~ 128, default: 2)		
Band Steering	<input type="checkbox"/> Enable Band Steering: Check Time for WLAN Client 5G Cap. <input type="text" value="15"/> seconds (1 ~ 60, default: 15)		
	<input type="checkbox"/> Minimum Basic Rate <input type="text" value="1"/> Mbps		



Info

The function of Auto Provision is available for the default WLAN profile.

- After finished the general settings configuration, click **Next** to open the following page for 2.4G wireless security settings.

Central Management >> AP >> WLAN Profile

SSID1	SSID2	SSID3	SSID4
2.4GHz SSID			
Active	<input checked="" type="radio"/> Enable <input type="radio"/> Disable		
SSID	DrayTek-LAN-A	LAN-A ▼	<input type="checkbox"/> Hide SSID
VLAN	0 (0:untag)		
Isolate	<input type="checkbox"/> From Member		
Security Settings			
Encryption	WPA+WPA2/PSK ▼		
	Set up RADIUS Server if 802.1X is enabled.		
	WPA		
	WPA Algorithms	<input type="radio"/> TKIP <input type="radio"/> AES <input checked="" type="radio"/> TKIP/AES	
	Pass Phrase	*****	
Key Renewal Interval	3600 Seconds		
WEP	Setup WEP Key if WEP is enabled.		
	802.1X WEP	<input type="radio"/> Enable <input checked="" type="radio"/> Disable	
Access Control			
Mode	None ▼		
List			
	Client's MAC Address : <input type="text"/> : <input type="text"/> : <input type="text"/> : <input type="text"/> : <input type="text"/> : <input type="text"/>		
	<input type="button" value="Add"/> <input type="button" value="Delete"/> <input type="button" value="Edit"/> <input type="button" value="Cancel"/>		
Bandwidth Limit			
Status	<input type="radio"/> Enable <input checked="" type="radio"/> Disable		Auto Adjustment <input type="radio"/> Enable <input checked="" type="radio"/> Disable
Upload	0 Kbps	Download	0 Kbps
Station Control			
Status	<input type="radio"/> Enable <input checked="" type="radio"/> Disable		
Connection Time	1 hour ▼	Reconnection Time	1 hour ▼

Note:

SSID can contain only A-Z a-z 0-9 _ - . @ # \$ % *

Backup ACL Cfg : <input type="button" value="Backup"/>	Upload From File: <input type="button" value="選擇檔案"/> 未選擇任何檔案	<input type="button" value="Restore"/>
--	---	--

- After finished the above web page configuration, click **Next** to open the following page for 5G wireless security settings.

Central Management >> AP >> WLAN Profile

5G SSID1	5G SSID2	5G SSID3	5G SSID4
5GHz SSID			
Active	<input checked="" type="radio"/> Enable <input type="radio"/> Disable		
SSID	DrayTek-5G	LAN-A ▾	<input type="checkbox"/> Hide SSID
VLAN	0 (0:untag)		
Isolate	<input type="checkbox"/> From Member		
Security Settings			
Encryption	Disable ▾		
	Set up RADIUS Server if 802.1X is enabled.		
	WPA		
	WPA Algorithms	<input type="radio"/> TKIP <input type="radio"/> AES <input checked="" type="radio"/> TKIP/AES	
	Pass Phrase	Max: 64 characters	
Key Renewal Interval	3600 Seconds		
WEP			
Setup WEP Key if WEP is enabled.			
802.1X WEP <input type="radio"/> Enable <input checked="" type="radio"/> Disable			
Access Control			
Mode	None ▾		
List			
	Client's MAC Address : <input type="text"/> : <input type="text"/> : <input type="text"/> : <input type="text"/> : <input type="text"/>		
<input type="button" value="Add"/> <input type="button" value="Delete"/> <input type="button" value="Edit"/> <input type="button" value="Cancel"/>			
Bandwidth Limit			
Status	<input type="radio"/> Enable <input checked="" type="radio"/> Disable		Auto Adjustment <input type="radio"/> Enable <input checked="" type="radio"/> Disable
Upload	0 Kbps	Download	0 Kbps
Station Control			
Status	<input type="radio"/> Enable <input checked="" type="radio"/> Disable		
Connection Time	1 hour ▾	Reconnection Time	1 hour ▾
Note:			
1. 5GHz SSID Configuration only work with VigorAP800 v1.1.1 and newer APM Client.			
2. SSID can contain only A-Z a-z 0-9 _ - . @ # \$ % *			
<input type="button" value="Back"/> <input type="button" value="Cancel"/> <input type="button" value="Next"/>			
Backup ACL Cfg : <input type="button" value="Backup"/>		Upload From File: <input type="button" value="選擇檔案"/> 未選擇任何檔案 <input type="button" value="Restore"/>	

- When you finished the above web page configuration, click **Finish** to exit and return to the first page. The modified WLAN profile will be shown on the web page.

Central Management >> AP >> WLAN Profile

Set to Factory Default									
Profile	Name	Main SSID	Security	Multi-SSID	WLAN ACL	Rate Ctrl	Clone	To AP	To Local
1	Default	DrayTek-LAN-A	WPA+WPA2/PSK	Enable	None	None			
2	123	DrayTek	Disable	Disable	None	None			
3	---	---	---	---	---	---	---	---	---
4	---	---	---	---	---	---	---	---	---
5	---	---	---	---	---	---	---	---	---

VI-3-4 AP Maintenance

Vigor router can execute configuration backup, configuration restoration, firmware upgrade and remote reboot for the APs managed by the router. It is very convenient for the administrator to process maintenance without accessing into the web user interface of the access point.



Info

Config Backup can be performed to one AP at one time. Others functions (e.g., Config Restore, Firmware Upgrade, Remote Reboot) can be performed to more than one AP at one time by using VigorLTE 200.

Central Management >> AP >> AP Maintenance

AP Maintenance

Select Action
 Action Type: ▾
 File/Path: 未選擇任何檔案

Select Device
 Existing Device:
 Selected Device:

»
 «
 »All
 «All

Available settings are explained as follows:

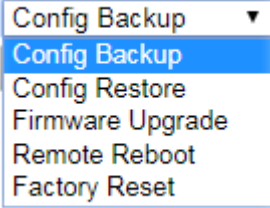
Item	Description
Action	<p>There are four actions provided by Vigor router to manage the access points.</p>  <p>Vigor router can backup the configuration of the selected AP, restore the configuration for the selected AP, perform the firmware upgrade of the selected AP, reboot the selected AP remotely and perform the factory reset for the selected AP.</p>
File/Path	Specify the file and the path which will be used to perform Config Restore or Firmware Upgrade .
Select Device	Display all the available access points managed by Vigor router. Simply click << or >> to move the device(s) between

	Select Device and Selected Device areas.
Selected Device	Display the access points that will be applied by such function after clicking OK.

After finishing all the settings here, please click **OK** to perform the action.

VI-3-5 Traffic Graph

Click **Traffic Graph** to open the web page. Choose one of the managed Access Points, LAN-A or LAN-B, daily or weekly for viewing data transmission chart. Click **Refresh** to renew the graph at any time.

Central Management >> AP >> Traffic Graph

Enable

Show Chart: VigorAP910C LAN-A Daily Refresh Min(s): 1 | **Refresh** |

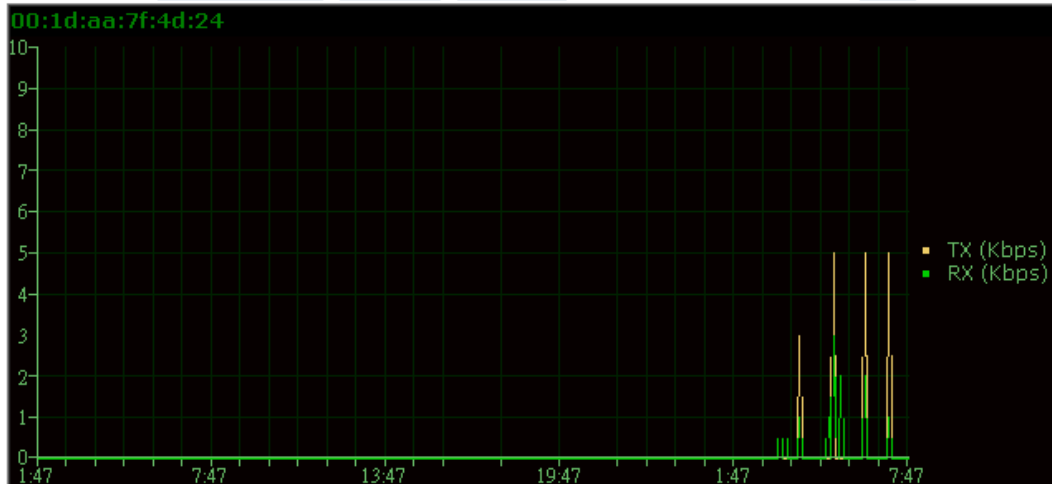

Note:

Enabling/Disabling AP Traffic Graph will also Enable/Disable the External Devices Function.

The horizontal axis represents time; the vertical axis represents the transmission rate (in kbps).



Info

Enabling/Disabling such function will also enable/disable the External Devices function.

VI-3-6 Temperature Sensor

Many VigorAPs and Vigor routers can be installed with temperature sensor. If VigorAP (e.g., VigorAP 910C) is managed under Vigor router, then Vigor router can obtain the temperature change graph of the USB temperature sensor installed onto VigorAP.

This page displays data including current temperature, maximum temperature, minimum temperature and average temperature.

Central Management >> AP >> Temperature Sensor

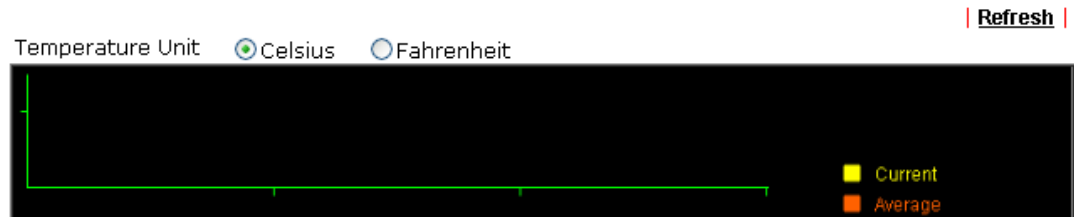

Note:

Only browser supporting [HTML5](#) can display temperature sensor correctly.

VI-3-7 Event Log

Time and event log for all of the APs managed by Vigor router will be shown on this page. It is useful for troubleshooting if required.

Central AP Management >> Event Log

| [Clear](#) | [Refresh](#) |

All Event Log

Time	APM Event Log	
2000-01-01 00:00:24	[APM] [Vigor&P900_01daa9e2b38]	Apply Rogue AP Detection settings
2000-01-01 00:00:24	[APM] [Vigor&P900_01daa9e2b38]	Apply Load Balance settings
2000-01-01 00:00:26	[APM] [Vigor&P900_01daa9e2b38]	Apply Rogue AP Detection settings S
2000-01-01 00:00:29	[APM] [Vigor&P900_01daa9e2b38]	Query AP status
2000-01-01 00:00:29	[APM] [Vigor&P900_01daa9e2b38]	Apply Load Balance settings success
2000-01-01 00:00:35	[APM] [Vigor&P900_01daa9e2b38]	Query AP status

VI-3-8 Total Traffic

Such page will display the total traffic of data receiving and data transmitting for VigorAPs managed by Vigor router.

Central AP Management >> Total Traffic

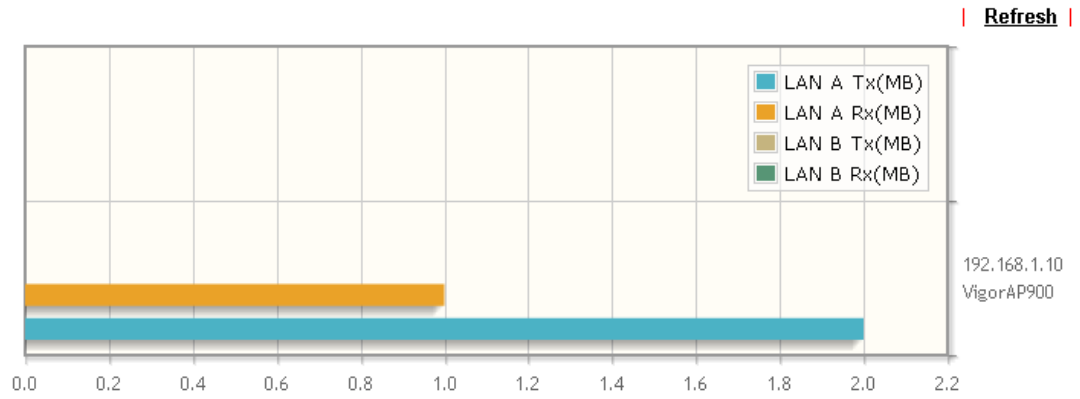

Note: Only browser supporting [HTML5](#) can display Total Traffic correctly.

VI-3-9 Station Number

The total number of the wireless clients will be shown on this page.

Central Management >> AP >> Station Number

Hourly Records(2 Hours)

Station Number

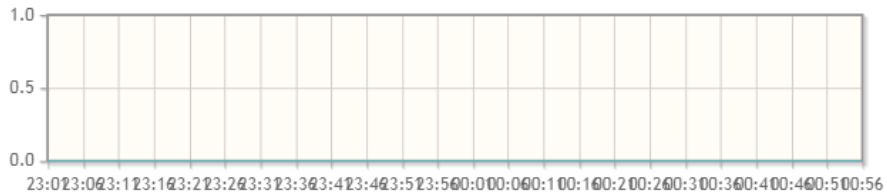

Note:

Only browser supporting [HTML5](#) can display Station Number correctly.

VI-3-10 Load Balance

The parameters configured for Load Balance can help to distribute the traffic for all of the access points registered to Vigor router. Thus, the bandwidth will not be occupied by certain access points.

Central Management >> AP >> Load Balance

AP Load Balance By Station Number or Traffic ▼

Station Number Threshold

Wireless LAN (2.4GHz) (3-128)
 Wireless LAN (5GHz) (3-128)
 Wireless LAN (5GHz-2) (3-128)

Traffic Threshold

Upload Limit User defined ▼ bps (Default unit: K)
 Download Limit User defined ▼ bps (Default unit: K)

Action When Threshold Exceeded

Stop accepting new connections
 Dissociate existing station by longest idle time
 Dissociate existing station by worst signal strength if it is less than dBm (%)

Choose to Apply

All APs ▼

Note:

The maximum station number of Wireless LAN (2.4GHz) will be applied to both Wireless LAN (2.4GHz) and Wireless LAN (5GHz) if the firmware version of AP900 is less than or equal to 1.1.4.1.

Available settings are explained as follows:

Item	Description
AP Load Balance	It is used to determine the operation mode when the system detects overload between access points. Disable - Disable the function of AP load balance. By Station Number -The operation of load balance will be executed based on the station number configured in this page. It is used to limit the allowed number for the station connecting to the access point. The purpose is to prevent lots of stations connecting to access point at the same time and causing traffic unbalanced. Please define the required station number for WLAN (2.4GHz) and WLAN (5GHz) separately. By Traffic - The operation of load balance will executed according to the traffic configuration in this page. By Station Number or Traffic - The operation of load balance will be executed based on the station number or the traffic configuration.
Station Number Threshold	Set the number of stations as a threshold to activate AP load balance.
Traffic Threshold	Upload Limit -Use the drop down list to specify the traffic limit for uploading.

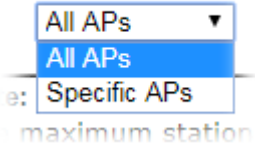
	<p>Download Limit - Use the drop down list to specify the traffic limit for downloading.</p>
<p>Action When Threshold Exceeded</p>	<p>Stop accepting new connections - When the number of stations or the traffic reaches the threshold defined in this web page, Vigor router will stop any new connection asked by other access point.</p> <p>Dissociate existing station by longest idel time - When the access point is overload (e.g., reaching the limit of station number or limit of network traffic), it will terminate the network connection of the client's station which is idle for a longest time.</p> <p>Dissociate existing station by worst signal strength if it is less than - When the access point is overload (e.g., reaching the limit of station number or limit of network traffic), it will terminate the network connection of the client's station with the weakest signal.</p>
<p>Choose to Apply</p>	<p>The settings configured for Load Balance can be applied to all of AP devices or selected AP devices.</p>  <p>The image shows a screenshot of a configuration interface. It features a dropdown menu with 'All APs' selected and highlighted in blue. Below the dropdown, there is a radio button labeled 'Specific APs' which is currently unselected. The text 'maximum station' is partially visible below the radio button.</p>

After finishing all the settings here, please click **OK** to save the configuration.

This page is left blank.

Part VII Others



Objects Settings

Define objects such as IP address, service type, keyword, file extension and others. These pre-defined objects can be applied in CSM.

VII-1 Objects Settings

Define objects such as IP address, service type, keyword, file extension and others. These pre-defined objects can be applied in CSM.

Web User Interface

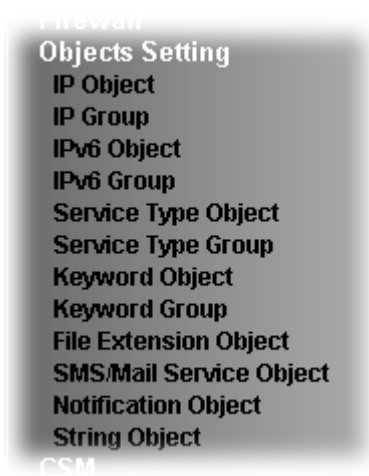

VII-1-1 IP Object

For IPs in a range and service ports in a limited range usually will be applied in configuring router's settings, therefore we can define them with *objects* and bind them with *groups* for using conveniently. Later, we can select that object/group that can apply it. For example, all the IPs in the same department can be defined with an IP object (a range of IP address).

You can set up to 192 sets of IP Objects with different conditions.

Objects Setting >> IP Object

[Create from ARP Table](#)
[Create from Routing Table](#)

| [Set to Factory Default](#) |

IP Object Profiles:

View:

Index	Name	Address	Index	Name	Address
1.	CARRIE		17.		
2.			18.		
3.			19.		
4.			20.		
5.			21.		
6.			22.		
7.			23.		
8.			24.		
9.			25.		
10.			26.		
11.			27.		
12.			28.		
13.			29.		
14.			30.		
15.			31.		
16.			32.		

<< [1-32](#) | [33-64](#) | [65-96](#) | [97-128](#) | [129-160](#) | [161-192](#) >> [Next](#) >>

<p>Export IP Object</p> <ul style="list-style-type: none"> <input checked="" type="radio"/> Backup the current IP Objects with a CSV file <input type="radio"/> Download the default CSV template to edit <input type="button" value="Download"/>	<p>Restore IP Object</p> <p><input type="button" value="選擇檔案"/> 未選擇任何檔案</p> <input type="button" value="Restore"/>
--	---

Note:
 For better compatibility, it's suggested to edit IP Objets with the provided default CSV template.

Available settings are explained as follows:

Item	Description
View	Use the drop down list to choose a type (Single Address, Range Address, Subnet Address, Mac Address or all) that IP object with the selected type will be shown on this page.
Set to Factory Default	Clear all profiles.
Search	Type a string of the IP object that you want to search.
Index	Display the profile number that you can configure.
Name	Display the name of the object profile.
Address	Display the IP address configured for the object profile.
Export IP Object	<p>Usually, the IP objects can be created one by one through the web page of Objects>>IP Object. However, to a user who wants to save more time in bulk creating IP objects, a quick method is offered by Vigor router to modify the IP objects with a single file, a CSV file.</p> <p>All of the IP objects (or the template) can be exported as a file by clicking Download. Then the user can open the CSV file through Microsoft Excel and modify all the IP objects at the same time.</p> <p>Backup the current IP Objects with a CSV file - Click it to backup current IP objects as a CSV file. Such file can be restored for future use.</p> <p>Download the default CSV template to edit - After clicking</p>

	it, press Download to store the default CSM template (a table without any input data) to your hard disk. Download - Download the CSV file from Vigor router and store in your hard disk.
Restore IP Object	Select - Click it to specify a predefined CSV file. Restore - Import the selected CSV file onto Vigor router.

To set a new profile, please do the steps listed below:

1. Click the number (e.g., #1) under Index column for configuration in details.
2. The configuration page will be shown as follows:

Objects Setting >> IP Object

Profile Index : 1

Name:	RD Department
Interface:	Any
Address Type:	Range Address
Mac Address:	00 :00 :00 :00 :00 :00
Start IP Address:	192.168.1.59 <input type="button" value="Select"/>
End IP Address:	192.168.1.65 <input type="button" value="Select"/>
Subnet Mask:	255.255.255.254 / 31
Invert Selection:	<input type="checkbox"/>

[Next >>](#)

Available settings are explained as follows:

Item	Description
Name	Type a name for this profile. Maximum 15 characters are allowed.
Interface	Choose a proper interface. For example, the Direction setting in Edit Filter Rule will ask you specify IP or IP range for WAN or LAN/RT/VPN or any IP address. If you choose LAN/ RT/VPN as the Interface here, and choose LAN/RT/VPN as the direction setting in Edit Filter Rule , then all the IP addresses specified with LAN/ RT/VPN interface will be opened for you to choose in Edit Filter Rule page.
Address Type	Determine the address type for the IP address. Select Single Address if this object contains one IP address only. Select Range Address if this object contains several IPs within a range. Select Subnet Address if this object contains one subnet for IP address. Select Any Address if this object contains any IP address. Select Mac Address if this object contains Mac address.
MAC Address	Enter the MAC address of the network card which will be controlled.
Start IP Address	Enter the start IP address for Single Address type.
End IP Address	Enter the end IP address if the Range Address type is selected.

Subnet Mask	Enter the subnet mask if the Subnet Address type is selected.
Invert Selection	If it is checked, all the IP addresses except the ones listed above will be applied later while it is chosen.

- After finishing all the settings here, please click **OK** to save the configuration. Below is an example of IP objects settings.

Objects Setting >> IP Object

IP Object Profiles:

Index	Name	Index
<u>1.</u>	RD Department	<u>17.</u>
<u>2.</u>	Financial Dept	<u>18.</u>
<u>3.</u>	HR Department	<u>19.</u>
<u>4.</u>		<u>20.</u>
<u>5.</u>		<u>21.</u>
6.		22.

VII-1-2 IP Group

This page allows you to bind several IP objects into one IP group.

Objects Setting >> IP Group

IP Group Table: [Set to Factory Default](#)

Index	Name	Index	Name
<u>1.</u>		<u>17.</u>	
<u>2.</u>		<u>18.</u>	
<u>3.</u>		<u>19.</u>	
<u>4.</u>		<u>20.</u>	
<u>5.</u>		<u>21.</u>	
<u>6.</u>		<u>22.</u>	
<u>7.</u>		<u>23.</u>	
<u>8.</u>		<u>24.</u>	
<u>9.</u>		<u>25.</u>	
<u>10.</u>		<u>26.</u>	
<u>11.</u>		<u>27.</u>	
<u>12.</u>		<u>28.</u>	
<u>13.</u>		<u>29.</u>	
<u>14.</u>		<u>30.</u>	
<u>15.</u>		<u>31.</u>	
<u>16.</u>		<u>32.</u>	

Available settings are explained as follows:

Item	Description
Set to Factory Default	Clear all profiles.
Index	Display the profile number that you can configure.
Name	Display the name of the group profile.

To set a new profile, please do the steps listed below:

1. Click the number (e.g., #1) under Index column for configuration in details.
2. The configuration page will be shown as follows:

Objects Setting >> IP Group

Profile Index : 1

Name:

Interface:

Available IP Objects

- 1-RD Department
- 2-Financial Dept
- 3-HR Department

>>

<<

Selected IP Objects

Available settings are explained as follows:

Item	Description
Name	Type a name for this profile. Maximum 15 characters are allowed.
Interface	Choose WAN, LAN or Any to display all the available IP objects with the specified interface.
Available IP Objects	All the available IP objects with the specified interface chosen above will be shown in this box.
Selected IP Objects	Click >> button to add the selected IP objects in this box.

- After finishing all the settings here, please click OK to save the configuration.

VII-1-3 IPv6 Object

You can set up to 64 sets of IPv6 Objects with different conditions.

Objects Setting >> IPv6 Object

IPv6 Object Profiles: [Set to Factory Default](#)

Index	Name	Index	Name
1.		17.	
2.		18.	
3.		19.	
4.		20.	
5.		21.	
6.		22.	
7.		23.	
8.		24.	
9.		25.	
10.		26.	
11.		27.	
12.		28.	
13.		29.	
14.		30.	
15.		31.	
16.		32.	

<< [1-32](#) | [33-64](#) >> [Next](#) >>

Available settings are explained as follows:

Item	Description
Set to Factory Default	Clear all profiles.
Index	Display the profile number that you can configure.
Name	Display the name of the object profile.

To set a new profile, please do the steps listed below:

1. Click the number (e.g., #1) under Index column for configuration in details.
2. The configuration page will be shown as follows:

Objects Setting >> IPv6 Object

Profile Index : 1

Name:	<input type="text"/>
Address Type:	Subnet Address ▾
Mac Address:	00 : 00 : 00 : 00 : 00 : 00
Start IP Address:	<input type="text"/> <input type="button" value="Select"/>
End IP Address:	<input type="text"/> <input type="button" value="Select"/>
Prefix Length:	<input type="text" value="0"/>
Invert Selection:	<input type="checkbox"/>

Available settings are explained as follows:

Item	Description
Name	Type a name for this profile. Maximum 15 characters are allowed.
Address Type	Determine the address type for the IPv6 address. Select Single Address if this object contains one IPv6 address only. Select Range Address if this object contains several IPv6s within a range. Select Subnet Address if this object contains one subnet for IPv6 address. Select Any Address if this object contains any IPv6 address. Select Mac Address if this object contains Mac address.
Mac Address	Enter the MAC address of the network card which will be controlled.
Start IP Address	Enter the start IP address for Single Address type.
End IP Address	Enter the end IP address if the Range Address type is selected.
Prefix Length	Enter the number (e.g., 64) for the prefix length of IPv6 address.
Invert Selection	If it is checked, all the IPv6 addresses except the ones listed above will be applied later while it is chosen.

3. After finishing all the settings, please click **OK** to save the configuration.

VII-1-4 IPv6 Group

This page allows you to bind several IPv6 objects into one IPv6 group.

Objects Setting >> IPv6 Group

IPv6 Group Table: | [Set to Factory Default](#) |

Index	Name	Index	Name
1.		17.	
2.		18.	
3.		19.	
4.		20.	
5.		21.	
6.		22.	
7.		23.	
8.		24.	
9.		25.	
10.		26.	
11.		27.	
12.		28.	
13.		29.	
14.		30.	
15.		31.	
16.		32.	

Available settings are explained as follows:

Item	Description
Set to Factory Default	Clear all profiles.
Index	Display the profile number that you can configure.
Name	Display the name of the group profile.

To set a new profile, please do the steps listed below:

1. Click the number (e.g., #1) under Index column for configuration in details.
2. The configuration page will be shown as follows:

Objects Setting >> IPv6 Group

Profile Index : 1

Name:

Available IPv6 Objects

>>

<<

Selected IPv6 Objects

Available settings are explained as follows:

Item	Description
Name	Type a name for this profile. Maximum 15 characters are allowed.
Available IPv6 Objects	All the available IPv6 objects with the specified interface chosen above will be shown in this box.
Selected IPv6 Objects	Click >> button to add the selected IPv6 objects in this box.

- After finishing all the settings, please click OK to save the configuration.

VII-1-5 Service Type Object

You can set up to 96 sets of Service Type Objects with different conditions.

Objects Setting >> Service Type Object

Service Type Object Profiles: | [Set to Factory Default](#) |

Index	Name	Index	Name
1.		17.	
2.		18.	
3.		19.	
4.		20.	
5.		21.	
6.		22.	
7.		23.	
8.		24.	
9.		25.	
10.		26.	
11.		27.	
12.		28.	
13.		29.	
14.		30.	
15.		31.	
16.		32.	

<< [1-32](#) | [33-64](#) | [65-96](#) >> [Next](#) >>

Available settings are explained as follows:

Item	Description
Set to Factory Default	Clear all profiles.
Index	Display the profile number that you can configure.
Name	Display the name of the object profile.

To set a new profile, please do the steps listed below:

1. Click the number (e.g., #1) under Index column for configuration in details.
2. The configuration page will be shown as follows:

Objects Setting >> Service Type Object Setup

Profile Index : 1

Name	www	
Protocol	Any	
Source Port	=	1 ~ 65535
Destination Port	=	1 ~ 65535

Available settings are explained as follows:

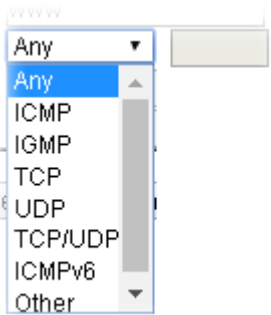
Item	Description
Name	Type a name for this profile. Maximum 15 characters are allowed.
Protocol	Specify the protocol(s) which this profile will apply to. 
Source/Destination Port	<p>Source Port and the Destination Port columns are available for TCP/UDP protocol. It can be ignored for other protocols. The filter rule will filter out any port number.</p> <p>(=) - when the first and last value are the same, it indicates one port; when the first and last values are different, it indicates a range for the port and available for this profile.</p> <p>(!=) - when the first and last value are the same, it indicates all the ports except the port defined here; when the first and last values are different, it indicates that all the ports except the range defined here are available for this service type.</p> <p>(>) - the port number greater than this value is available.</p> <p>(<) - the port number less than this value is available for this profile.</p>

- After finishing all the settings, please click OK to save the configuration.

Objects Setting >> Service Type Object

Service Type Object Profiles:

Index	Name	Index
<u>1.</u>	www	<u>17.</u>
<u>2.</u>	SIP	<u>18.</u>
<u>3.</u>		<u>19.</u>
<u>4.</u>		<u>20.</u>

VII-1-6 Service Type Group

This page allows you to bind several service types into one group.

Objects Setting >> Service Type Group

Service Type Group Table:

[Set to Factory Default](#)

Group	Name	Group	Name
<u>1.</u>		<u>17.</u>	
<u>2.</u>		<u>18.</u>	
<u>3.</u>		<u>19.</u>	
<u>4.</u>		<u>20.</u>	
<u>5.</u>		<u>21.</u>	
<u>6.</u>		<u>22.</u>	
<u>7.</u>		<u>23.</u>	
<u>8.</u>		<u>24.</u>	
<u>9.</u>		<u>25.</u>	
<u>10.</u>		<u>26.</u>	
<u>11.</u>		<u>27.</u>	
<u>12.</u>		<u>28.</u>	
<u>13.</u>		<u>29.</u>	
<u>14.</u>		<u>30.</u>	
<u>15.</u>		<u>31.</u>	
<u>16.</u>		<u>32.</u>	

Available settings are explained as follows:

Item	Description
Set to Factory Default	Clear all profiles.
Index	Display the profile number that you can configure.
Name	Display the name of the group profile.

To set a new profile, please do the steps listed below:

1. Click the number (e.g., #1) under Group column for configuration in details.
2. The configuration page will be shown as follows:

Objects Setting >> Service Type Group Setup

Profile Index : 1

Name:

Available Service Type Objects

- 1-www
- 2-SIP

Selected Service Type Objects

>> <<

OK Clear Cancel

Available settings are explained as follows:

Item	Description
Name	Type a name for this profile. Maximum 15 characters are allowed.
Available Service Type Objects	All the available service objects that you have added on Objects Setting>>Service Type Object will be shown in this box.
Selected Service Type Objects	Click >> button to add the selected IP objects in this box.

3. After finishing all the settings, please click OK to save the configuration.

VII-1-7 Keyword Object

You can set 200 keyword object profiles for choosing as black /white list in CSM >>URL Web Content Filter Profile.

Objects Setting >> Keyword Object

Keyword Object Profiles: | [Set to Factory Default](#) |

Index	Name	Index	Name
1.		17.	
2.		18.	
3.		19.	
4.		20.	
5.		21.	
6.		22.	
7.		23.	
8.		24.	
9.		25.	
10.		26.	
11.		27.	
12.		28.	
13.		29.	
14.		30.	
15.		31.	
16.		32.	

<< [1-32](#) | [33-64](#) | [65-96](#) | [97-128](#) | [129-160](#) | [161-192](#) | [193-200](#) >> [Next](#) >>

Available settings are explained as follows:

Item	Description
Set to Factory Default	Clear all profiles.
Index	Display the profile number that you can configure.
Name	Display the name of the object profile.

To set a new profile, please do the steps listed below:

1. Click the number (e.g., #1) under Index column for configuration in details.
2. The configuration page will be shown as follows:

Objects Setting >> Keyword Object Setup

Profile Index : 1

Name	<input type="text"/>
Contents	<input type="text"/>
Limit of Contents: Max 3 Words and 63 Characters. Each word should be separated by a single space.	
You can replace a character with %HEX. Example: Contents: backdoo%72 virus keep%20out	
Result: 1. backdoor 2. virus 3. keep out	

Available settings are explained as follows:

Item	Description
Name	Type a name for this profile, e.g., game. Maximum 15 characters are allowed.
Contents	Enter the content for such profile. For example, type <i>gambling</i> as Contents. When you browse the webpage, the page with gambling information will be watched out and be passed/blocked based on the configuration on Firewall settings.

3. After finishing all the settings, please click **OK** to save the configuration.

VII-1-8 Keyword Group

This page allows you to bind several keyword objects into one group. The keyword groups set here will be chosen as black /white list in CSM >>URL /Web Content Filter Profile.

Objects Setting >> Keyword Group

Keyword Group Table: | [Set to Factory Default](#) |

Index	Name	Index	Name
1.		17.	
2.		18.	
3.		19.	
4.		20.	
5.		21.	
6.		22.	
7.		23.	
8.		24.	
9.		25.	
10.		26.	
11.		27.	
12.		28.	
13.		29.	
14.		30.	
15.		31.	
16.		32.	

Available settings are explained as follows:

Item	Description
Set to Factory Default	Clear all profiles.
Index	Display the profile number that you can configure.
Name	Display the name of the group profile.

To set a new profile, please do the steps listed below:

1. Click the number (e.g., #1) under Index column for configuration in details.
2. The configuration page will be shown as follows:

Objects Setting >> Keyword Group Setup

Profile Index : 1

Name:

Available Keyword Objects

- 1-Key-1
- 2-Key-2

>>

<<

Selected Keyword Objects(Max 16 Objects)

Available settings are explained as follows:

Item	Description
Name	Type a name for this group. Maximum 15 characters are allowed.
Available Keyword Objects	You can gather keyword objects from Keyword Object page within one keyword group. All the available Keyword objects that you have created will be shown in this box.
Selected Keyword Objects	Click <input data-bbox="778 488 852 533" type="button" value=" >> "/> button to add the selected Keyword objects in this box.

3. After finishing all the settings, please click **OK** to save the configuration.

VII-1-9 File Extension Object

This page allows you to set eight profiles which will be applied in **CSM>>URL Content Filter**. All the files with the extension names specified in these profiles will be processed according to the chosen action.

Objects Setting >> File Extension Object

File Extension Object Profiles: | [Set to Factory Default](#) |

Profile	Name	Profile	Name
<u>1.</u>		<u>5.</u>	
<u>2.</u>		<u>6.</u>	
<u>3.</u>		<u>7.</u>	
<u>4.</u>		<u>8.</u>	

Available settings are explained as follows:

Item	Description
Set to Factory Default	Clear all profiles.
Profile	Display the profile number that you can configure.
Name	Display the name of the object profile.

To set a new profile, please do the steps listed below:

1. Click the number (e.g., #1) under Profile column for configuration in details.
2. The configuration page will be shown as follows:

Objects Setting >> File Extension Object Setup

Profile Index: 1 Profile Name:

Categories	File Extensions
Image	
<input type="button" value="Select All"/>	<input type="checkbox"/> .bmp <input type="checkbox"/> .dib <input type="checkbox"/> .gif <input type="checkbox"/> .jpeg <input type="checkbox"/> .jpg <input type="checkbox"/> .jpg2 <input type="checkbox"/> .jp2
<input type="button" value="Clear All"/>	<input type="checkbox"/> .pct <input type="checkbox"/> .pcx <input type="checkbox"/> .pic <input type="checkbox"/> .pict <input type="checkbox"/> .png <input type="checkbox"/> .tif <input type="checkbox"/> .tiff
Video	
<input type="button" value="Select All"/>	<input type="checkbox"/> .asf <input type="checkbox"/> .avi <input type="checkbox"/> .mov <input type="checkbox"/> .mpe <input type="checkbox"/> .mpeg <input type="checkbox"/> .mpg <input type="checkbox"/> .mp4
<input type="button" value="Clear All"/>	<input type="checkbox"/> .qt <input type="checkbox"/> .rm <input type="checkbox"/> .wmv <input type="checkbox"/> .3gp <input type="checkbox"/> .3gpp <input type="checkbox"/> .3gpp2 <input type="checkbox"/> .3g2
	<input type="checkbox"/> .flv <input type="checkbox"/> .swf
Audio	
<input type="button" value="Select All"/>	<input type="checkbox"/> .aac <input type="checkbox"/> .aiff <input type="checkbox"/> .au <input type="checkbox"/> .mp3 <input type="checkbox"/> .m4a <input type="checkbox"/> .m4p <input type="checkbox"/> .ogg
<input type="button" value="Clear All"/>	<input type="checkbox"/> .ra <input type="checkbox"/> .ram <input type="checkbox"/> .vox <input type="checkbox"/> .wav <input type="checkbox"/> .wma
Java	
<input type="button" value="Select All"/>	<input type="checkbox"/> .class <input type="checkbox"/> .jad <input type="checkbox"/> .jar <input type="checkbox"/> .jav <input type="checkbox"/> .java <input type="checkbox"/> .jcm <input type="checkbox"/> .js
<input type="button" value="Clear All"/>	<input type="checkbox"/> .jse <input type="checkbox"/> .jsp <input type="checkbox"/> .jtk
ActiveX	

Available settings are explained as follows:

Item	Description
Profile Name	Type a name for this profile. The maximum length of the name you can set is 7 characters.

3. Type a name for such profile and check all the items of file extension that will be processed in the router. Finally, click **OK** to save this profile.

VII-1-10 SMS Service Object

This page allows you to set ten profiles which will be applied in Application>>SMS Service Object.

Objects Setting >> SMS Service Object

SMS Provider		Set to Factory Default
Index	Profile Name	SMS Provider
1.		
2.		
3.		
4.		
5.		
6.		
7.		
8.		
9.	Custom 1	
10.	Custom 2	

Each item is explained as follows:

Item	Description
Set to Factory Default	Clear all of the settings and return to factory default settings.
Index	Display the profile number that you can configure.
Profile Name	Display the name for such SMS profile.
SMS Provider	Display the service provider which offers SMS service.

To set a new profile, please do the steps listed below:

1. Click the number (e.g., #1) under Index column for configuration in details.
2. The configuration page will be shown as follows:

Objects Setting >> SMS Service Object

Profile Index: 1

Profile Name	<input type="text" value="Line_down"/>
Service Provider	<input type="text" value="kotsms.com.tw (TW)"/>
Username	<input type="text" value="line1"/>
Password	<input type="password" value="....."/>
Quota	<input type="text" value="10"/>
Sending Interval	<input type="text" value="3"/> (seconds)

Note:

1. Only one message can be sent during the "Sending Interval" time.
2. If the "Sending Interval" was set to 0, there will be no limitation.

Available settings are explained as follows:

Item	Description
Profile Name	Type a name for such SMS profile. The maximum length of the name you can set is 31 characters.

Service Provider	<p>Use the drop down list to specify the service provider which offers SMS service.</p> 
Username	<p>Type a user name that the sender can use to register to selected SMS provider.</p> <p>The maximum length of the name you can set is 31 characters.</p>
Password	<p>Type a password that the sender can use to register to selected SMS provider.</p> <p>The maximum length of the password you can set is 31 characters.</p>
Quota	<p>Enter the number of the credit that you purchase from the service provider chosen above.</p> <p>Note that one credit equals to one SMS text message on the standard route.</p>
Sending Interval	<p>To avoid quota being exhausted soon, type time interval for sending the SMS.</p>

- After finishing all the settings here, please click **OK** to save the configuration.

Objects Setting >> SMS Service Object

SMS Provider		
Index	Profile Name	SMS Provider
1.	Line_down	kotsms.com.tw (TW)
2.		
3.		
4.		
5.		
6.		
7.		
8.		
9.	Custom 1	
10.	Custom 2	

Customized SMS Service

Vigor router offers several SMS service provider to offer the SMS service. However, if your service provider cannot be found from the service provider list, simply use Index 9 and Index 10 to make customized SMS service. The profile name for Index 9 and Index 10 are fixed.

Objects Setting >> SMS Service Object

SMS Provider			Set to Factory Default
Index	Profile Name	SMS Provider	
1.			
2.			
3.			
4.			
5.			
6.			
7.			
8.			
9.	Custom 1		
10.	Custom 2		

You can click the number (e.g., #9) under Index column for configuration in details.

Objects Setting >> SMS Service Object

Profile Index: 9

Profile Name	<input type="text" value="Custom 1"/>
Service Provider	<input type="text"/>
<div style="border: 1px solid gray; height: 40px;"></div>	
Please contact with your SMS provide to get the exact URL String eg: bulksms.vsms.net:5567/eapi/submission/send_sms/2/2.0?username=###txtUser###&password=###txtPwd###&msisdn=###txtDest###&message=###txtMsg###	
Username	<input type="text" value="Max: 31 characters"/>
Password	<input type="text" value="Max: 31 characters"/>
Quota	<input type="text" value="10"/>
Sending Interval	<input type="text" value="3"/> (seconds)

Note:

1. Only one message can be sent during the "Sending Interval" time.
2. If the "Sending Interval" was set to 0, there will be no limitation.

Available settings are explained as follows:

Item	Description
Profile Name	Display the name of this profile. It cannot be modified.
Service Provider	Enter the website of the service provider. Enter the URL string in the box under the filed of Service Provider. You have to contact your SMS provider to obtain the exact URL string.
Username	Type a user name that the sender can use to register to selected SMS provider. The maximum length of the name you can set is 31

	characters.
Password	Type a password that the sender can use to register to selected SMS provider. The maximum length of the password you can set is 31 characters.
Quota	Enter the total number of the messages that the router will send out.
Sending Interval	Enter the shortest time interval for the system to send SMS.

After finishing all the settings here, please click **OK** to save the configuration.

VII-1-11 Notification Object

This page allows you to set ten profiles which will be applied in **Application>>SMS Alert Service**.

You can set an object with different monitoring situation.

[Object Settings >> Notification Object](#)

Set to Factory Default		
Index	Profile Name	Settings
<u>1.</u>		
<u>2.</u>		
<u>3.</u>		
<u>4.</u>		
<u>5.</u>		
<u>6.</u>		
<u>7.</u>		
<u>8.</u>		

To set a new profile, please do the steps listed below:

1. Open **Object Setting>>Notification Object**, and click the number (e.g., #1) under Index column for configuration in details.

[Object Settings >> Notification Object](#)

Index	Profile Name
<u>1.</u>	
<u>2.</u>	
<u>3.</u>	
<u>4.</u>	
<u>5.</u>	

- The configuration page will be shown as follows:

Objects Setting >> Notification Object

Profile Index: 1

Profile Name	<input type="text"/>	
Category	Status	
WAN	<input type="checkbox"/> Disconnected	<input type="checkbox"/> Reconnected
VPN Tunnel	<input type="checkbox"/> Disconnected	<input type="checkbox"/> Reconnected

Available settings are explained as follows:

Item	Description
Profile Name	Type a name for such notification profile. The maximum length of the name you can set is 15 characters.
Category	Display the types that will be monitored.
Status	Display the status for the category. You can check the box to be monitored.

- After finishing all the settings here, please click **OK** to save the configuration.

Object Settings >> Notification Object

[Set to Factory Default](#)

Index	Profile Name	Settings
<u>1.</u>	Notify_attack	WAN VPN
<u>2.</u>		
<u>3.</u>		

VII-1-12 String Object

This page allows you to set string profiles which will be applied in route policy (domain name selection for destination) and etc.

Objects Setting >> String Object

10 strings per page | [Set to Factory Default](#) |

Index	String	
1	123	<input type="checkbox"/>
2	TEST_RD	<input type="checkbox"/>

Available settings are explained as follows:

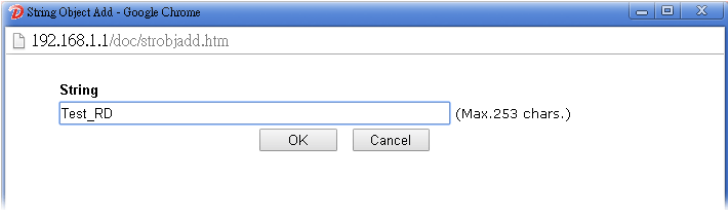
Item	Description
Add	Click it to open the following page for adding a new string object. 
Set to Factory Default	Click it to clear all of the settings in this page.
Index	Display the number link of the string profile.
String	Display the string defined.
Clear	Choose the string that you want to remove. Then click this check box to delete the selected string.

Application Notes

A-1 How to Send a Notification to Specified Phone Number via SMS Service in WAN Disconnection

Follow the steps listed below:

1. Log into the web user interface of Vigor router.
2. Configure relational objects first. Open **Object Settings>>SMS Server Object** to get the following page.

Objects Setting >> SMS Service Object

SMS Provider		Set to Factory Default
Index	Profile Name	SMS Provider
1.		kotsms.com.tw (TW)
2.		
3.		
4.		
5.		
6.		
7.		
8.		
9.	Custom 1	
10.	Custom 2	

Index 1 to Index 8 allows you to choose the built-in SMS service provider. If the SMS service provider is not on the list, you can configure Index 9 and Index 10 to add the new service provider to Vigor router.

3. Choose any index number (e.g., Index 1 in this case) to configure the SMS Provider setting. In the following page, Enter the username and password and set the quota that the router can send the message out.

Objects Setting >> SMS Service Object

Profile Index: 1

Profile Name	<input type="text" value="Local number"/>
Service Provider	<input type="text" value="kotsms.com.tw (TW)"/>
Username	<input type="text" value="abc5026"/>
Password	<input type="password" value="....."/>
Quota	<input type="text" value="3"/>
Sending Interval	<input type="text" value="3"/> (seconds)

Note:

1. Only one message can be sent during the "Sending Interval" time.
2. If the "Sending Interval" was set to 0, there will be no limitation.

- After finished the settings, click **OK** to return to previous page. Now you have finished the configuration of the SMS Provider profile setting.

Objects Setting >> SMS Service Object

SMS Provider			Set to Factory Default
Index	Profile Name	SMS Provider	
1.	Local number	kotsms.com.tw (TW)	
2.			
3.			
4.			
5.			
6.			
7.			
8.			
9.	Custom 1		
10.	Custom 2		

- Open Object Settings>>Notification Object to configure the event conditions of the notification.

Object Settings >> Notification Object

			Set to Factory Default
Index	Profile Name	Settings	
1.			
2.			
3.			
4.			
5.			
6.			
7.			
8.			

- Choose any index number (e.g., Index 1 in this case) to configure conditions for sending the SMS. In the following page, Enter the name of the profile and check the Disconnected and Reconnected boxes for WAN to work in concert with the topic of this paper.

Objects Setting >> Notification Object

Profile Index: 1

Profile Name		WAN_Notify	
Category	Status		
WAN	<input checked="" type="checkbox"/> Disconnected	<input checked="" type="checkbox"/> Reconnected	
VPN Tunnel	<input type="checkbox"/> Disconnected	<input type="checkbox"/> Reconnected	

- After finished the settings, click **OK** to return to previous page. You have finished the configuration of the notification object profile setting.

Object Settings >> Notification Object

Set to Factory Default		
Index	Profile Name	Settings
1.	WAN_Notify	WAN
2.		
3.		
4.		
5.		
6.		
7.		
8.		

- Now, open **Applications >> SMS Alert Service**. Use the drop down list to choose SMS Provider and the Notify Profile (specify the time of sending SMS). Then, Enter the phone number in the field of Recipient Number (the one who will receive the SMS).

Applications >> SMS Alert Service

Set to Factory Default					
Index	Enable	SMS Provider	Recipient Number	Notify Profile	Schedule(1-15)
1	<input checked="" type="checkbox"/>	1 - Local number ▼	0912345678	1 - WAN_Notify ▼	
2	<input type="checkbox"/>	1 - Local number ▼		1 - WAN_Notify ▼	
3	<input type="checkbox"/>	1 - Local number ▼		1 - WAN_Notify ▼	
4	<input type="checkbox"/>	1 - Local number ▼		1 - WAN_Notify ▼	
5	<input type="checkbox"/>	1 - Local number ▼		1 - WAN_Notify ▼	
6	<input type="checkbox"/>	1 - Local number ▼		1 - WAN_Notify ▼	
7	<input type="checkbox"/>	1 - Local number ▼		1 - WAN_Notify ▼	
8	<input type="checkbox"/>	1 - Local number ▼		1 - WAN_Notify ▼	
9	<input type="checkbox"/>	1 - Local number ▼		1 - WAN_Notify ▼	
10	<input type="checkbox"/>	1 - Local number ▼		1 - WAN_Notify ▼	

Note:

- All the SMS Alert profiles share the same "Sending Interval" setting if they use the same SMS Provider.
- If SMS Provider is "LTE Modem", the "Quota" is controlled by LTE >> [SMS Quota Limit](#) and the "Sending Interval" is 3 seconds.

- Click **OK** to save the settings. Later, if one of the WAN connections fails in your router, the system will send out SMS to the phone number specified. If the router has only one WAN interface, the system will send out SMS to the phone number while reconnecting the WAN interface successfully.

Remark: How the customize the SMS Provider

Choose one of the Index numbers (9 or 10) allowing you to customize the SMS Provider. In the web page, Enter the URL string of the SMS provider and Enter the username and password. After clicking OK, the new added SMS provider will be added and will be available for you to specify for sending SMS out.

Objects Setting >> SMS / Mail Service Object

Profile Index: 9

Profile Name	Custom 1
Service Provider	clickatell
<div style="border: 1px solid black; height: 50px; width: 100%;"></div>	
Please contact with your SMS provide to get the exact URL String eg: bulksms.vsms.net:5567/eapi/submission/send_sms/2/2.0? username=###txtUser### &password=###txtPwd###&msisdn=###txtDest###&message=###txtMsg###	
Username	ilan123
Password	*****
Quota	10
Sending Interval	3 (seconds)

Note:

1. Only one message can be sent during the "Sending Interval" time.
2. If the "Sending Interval" was set to 0, there will be no limitation.

OK Clear Cancel

This page is left blank.

Part VIII Troubleshooting



Troubleshooting

This part will guide you to solve abnormal situations if you cannot access into the Internet after installing the router and finishing the web configuration.

VIII-1 Diagnostics

This section will guide you to solve abnormal situations if you cannot access into the Internet after installing the router and finishing the web configuration. Please follow sections below to check your basic installation status stage by stage.

- Checking if the hardware status is OK or not.
- Checking if the network connection settings on your computer are OK or not.
- Pinging the router from your computer.
- Checking if the ISP settings are OK or not.
- Backing to factory default setting if necessary.

If all above stages are done and the router still cannot run normally, it is the time for you to contact your dealer or DrayTek technical support for advanced help.

Web User Interface

First, take a look at the menu items under Diagnostics. Diagnostic Tools provide a useful way to view or diagnose the status of your Vigor router.

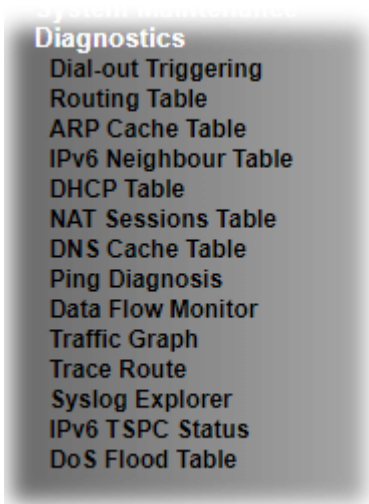

VIII-1-1 Dial-out Triggering

Click **Diagnostics** and click **Dial-out Triggering** to open the web page. The internet connection (e.g., PPPoE) is triggered by a package sending from the source IP address.

Diagnostics >> Dial-out Triggering

Dial-out Triggered Packet Header | [Refresh](#) |

HEX Format:

```
00 00 00 00 00 00-00 00 00 00 00 00-00 00
```



```
00 00 00 00 00 00 00 00-00 00 00 00 00 00 00
00 00 00 00 00 00 00 00-00 00 00 00 00 00 00
00 00 00 00 00 00 00 00-00 00 00 00 00 00 00
00 00 00 00 00 00 00 00-00 00 00 00 00 00 00
```

Decoded Format:

```
0.0.0.0 -> 0.0.0.0
Pr 0 len 0 (0)
```

Available settings are explained as follows:

Item	Description
Decoded Format	It shows the source IP address (local), destination IP (remote) address, the protocol and length of the package.
Refresh	Click it to reload the page.

VIII-1-2 Routing Table

Click Diagnostics and click Routing Table to open the web page.

Diagnostics >> View Routing Table

IPv4

| Refresh |

Key	Destination	Gateway	Interface
C~	192.168.1.0/ 255.255.255.0	directly connected	LAN1

Key

C: Connected S: Static R: RIP *: default ~: private

Note:

WAN5, WAN6, WAN7 are router-borne WANs.

IPv6

| Refresh |

Destination	Interface	Flags	Metric	Next Hop
FE80::/64	LAN1	U	256	::
FE80::/64	LAN2	U	256	::
FE80::/64	DMZ	U	256	::
FF00::/8	LAN1	U	256	::
FF00::/8	LAN2	U	256	::
FF00::/8	DMZ	U	256	::

Show Detail

Available settings are explained as follows:

Item	Description
Refresh	Click it to reload the page.

VIII-1-3 ARP Cache Table

Click **Diagnostics** and click **ARP Cache Table** to view the content of the ARP (Address Resolution Protocol) cache held in the router. The table shows a mapping between an Ethernet hardware address (MAC Address) and an IP address.

Diagnostics >> View ARP Cache Table

LAN		WAN	
Show:	ALL LANs ▼	and	ALL VLANs ▼
Ethernet	ALL LANs		Clear Refresh
IP Address	LAN1 LAN2 IP Routed Subnet	MAC Address	HOST ID
192.168.1.1		4C-E6-5A-4F	
			Interface VLAN Port
			LAN1 --- P2

Show Comment

Available settings are explained as follows:

Item	Description
Show	Specify LAN and VLAN to display related information. In default, this page will display all of the information about LAN and VLAN.
Refresh	Click it to reload the page.

VIII-1-4 IPv6 Neighbour Table

The table shows a mapping between an Ethernet hardware address (MAC Address) and an IPv6 address. This information is helpful in diagnosing network problems, such as IP address conflicts, etc.

Click **Diagnostics** and click **IPv6 Neighbour Table** to open the web page.

Diagnostics >> View IPv6 Neighbour Table

IPv6 Neighbour Table			Refresh
IPv6 Address	Mac Address	Interface	State
FF02::1:3	33-33-00-01-00-03	LAN1	CONNECTED

Available settings are explained as follows:

Item	Description
Refresh	Click it to reload the page.

VIII-1-5 DHCP Table

The facility provides information on IP address assignments. This information is helpful in diagnosing network problems, such as IP address conflicts, etc.

Click **Diagnostics** and click **DHCP Table** to open the web page.

Diagnostics >> View DHCP Assigned IP Addresses

Show : ALL LANs

DHCP IP Assignment Table | **Other IP Assignment Table** | [Refresh](#)

LAN1 : DHCP Server On IP Pool: 192.168.1.10 ~ 192.168.1.209

Index	IP Address	MAC Address	Leased Time	HOST ID
1	192.168.1.10	00-50-7F-F1-05-FD	22:08:44	

Show Comment

DHCPv6 IP Assignment Table | [Refresh](#)

Index	IPv6 Address	IAID	Link-layer Address	Lease
-------	--------------	------	--------------------	-------

Available settings are explained as follows:

Item	Description
Index	It displays the connection item number.
IP Address	It displays the IP address assigned by this router for specified PC.
MAC Address	It displays the MAC address for the specified PC that DHCP assigned IP address for it.
Leased Time	It displays the leased time of the specified PC.
HOST ID	It displays the host ID name of the specified PC.
Refresh	Click it to reload the page.

VIII-1-6 NAT Sessions Table

Click Diagnostics and click NAT Sessions Table to open the list page.

Diagnostics >> NAT Sessions Table

NAT Active Sessions Table (Limit: 128 entries)				Refresh
Private IP :Port	#Pseudo Port	Peer IP :Port	Interface	

Available settings are explained as follows:

Item	Description
Private IP:Port	It indicates the source IP address and port of local PC.
#Pseudo Port	It indicates the temporary port of the router used for NAT.
Peer IP:Port	It indicates the destination IP address and port of remote host.
Interface	It displays the representing number for different interface.
Refresh	Click it to reload the page.

VIII-1-7 DNS Cache Table

Click **Diagnostics** and click **DNS Cache Table** to open the web page.

The record of domain Name and the mapping IP address for answering the DNS query from LAN will be stored on Vigor router's Cache temporarily and displayed on **Diagnostics >> DNS Cache Table**.

Diagnostics >> DNS Cache Table

IPv4 DNS Cache Table

| [Clear](#) | [Refresh](#) |

Domain Name	IP Address	TTL(s)

IPv6 DNS Cache Table

| [Clear](#) | [Refresh](#) |

Domain Name	IP Address	TTL(s)

When an entry's TTL is larger than s, this entry will be deleted from the table.

OK

Available settings are explained as follows:

Item	Description
Clear	Click this link to remove the result on the window.
Refresh	Click it to reload the page.
When an entry's TTL is larger than....	Check the box the Enter the value of TTL (time to live) for each entry. Click OK to enable such function. It means when the TTL value of each DNS query reaches the threshold of the value specified here, the corresponding record will be deleted from router's Cache automatically.

VIII-1-8 Ping Diagnosis

Click Diagnostics and click Ping Diagnosis to open the web page.

Diagnostics >> Ping Diagnosis

Ping Diagnosis

Note:

1. If you want to ping a LAN PC or you don't want to specify which WAN to ping through, please select "Auto" in Ping Through.
2. If you select "Auto" in Source IP, we will fill Source IP according to the interface you ping through.

or

Diagnostics >> Ping Diagnosis

Ping Diagnosis

Note:

1. If you want to ping a LAN PC or you don't want to specify which WAN to ping through, please select "Auto" in Ping Through.
2. If you select "Auto" in Source IP, we will fill Source IP according to the interface you ping through.

Available settings are explained as follows:

Item	Description
IPV4 /IPV6	Choose the interface for such function.
Ping through	Use the drop down list to choose the WAN interface that you want to ping through or choose Auto to be determined by the router automatically.
Ping to	Use the drop down list to choose the destination that you

	want to ping.
IP Address	Enter the IP address of the Host/IP that you want to ping.
Ping IPv6 Address	Enter the IPv6 address that you want to ping.
Run	Click this button to start the ping work. The result will be displayed on the screen.
Clear	Click this link to remove the result on the window.

VIII-1-9 Data Flow Monitor

This page displays the running procedure for the IP address monitored and refreshes the data in an interval of several seconds. The IP address listed here is configured in Bandwidth Management. You have to enable IP bandwidth limit and IP session limit before invoking Data Flow Monitor. If not, a notification dialog box will appear to remind you enabling it.

[Bandwidth Management >> Sessions Limit](#)

Sessions Limit

Enable Disable

Default Max Sessions:

Limitation List

Index	Start IP	End IP

Click **Diagnostics** and click **Data Flow Monitor** to open the web page. You can click **IP Address**, **TX rate**, **RX rate** or **Session** link for arranging the data display.

Enable Data Flow Monitor

Refresh Seconds: Page:

| [Refresh](#) |

Index	IP Address	TX rate(Kbps)	RX rate(Kbps) ▾	Sessions	Action
		Current / Peak / Speed	Current / Peak / Speed	Current / Peak	
WAN1	---	0 / 0 / Auto	0 / 0 / Auto	0	
WAN2	---	0 / 0 / Auto	0 / 0 / Auto	0	
LTE	---	0 / 0 / Auto	0 / 0 / Auto	0	
Total		0 / 0 / Auto	0 / 0 / Auto	0 / 0	

Note:

1. Click "Block" to prevent specified PC from surfing Internet for 5 minutes.
2. The IP blocked by the router will be shown in red, and the session column will display the remaining time that the specified IP will be blocked.
3. When Data Flow Monitor is enabled, the function of Hardware Acceleration will not take effect, if it is enabled, to prevent from session conflicts.
4. (Kbps): shared bandwidth
+ : residual bandwidth used
Current/Peak are average.

Available settings are explained as follows:

Item	Description
Enable Data Flow Monitor	Check this box to enable this function.
Refresh Seconds	Use the drop down list to choose the time interval of refreshing data flow that will be done by the system automatically.
Refresh	Click this link to refresh this page manually.
Index	Display the number of the data flow.
IP Address	Display the IP address of the monitored device.
TX rate (kbps)	Display the transmission speed of the monitored device.
RX rate (kbps)	Display the receiving speed of the monitored device.
Sessions	Display the session number that you specified in Limit Session web page.
Action	Block - can prevent specified PC accessing into Internet within 5 minutes. Unblock -The device with the IP address will be blocked for five minutes. The remaining time will be shown on the session column. Click it to cancel the IP address blocking.
Current /Peak/Speed	Current means current transmission rate and receiving rate for WAN interface. Peak means the highest peak value detected by the router in data transmission. Speed means line speed specified in WAN>>General Setup.

If you do not specify any rate at that page, here will display Auto for instead.

VIII-1-10 Traffic Graph

Click **Diagnostics** and click **Traffic Graph** to open the web page. Choose WAN2/LTE Bandwidth, Sessions, Ping Detect, daily or weekly for viewing different traffic graph. Click **Reset** to zero the accumulated RX/TX (received and transmitted) data of WAN. Click **Refresh** to renew the graph at any time.

Diagnostics >> Traffic Graph

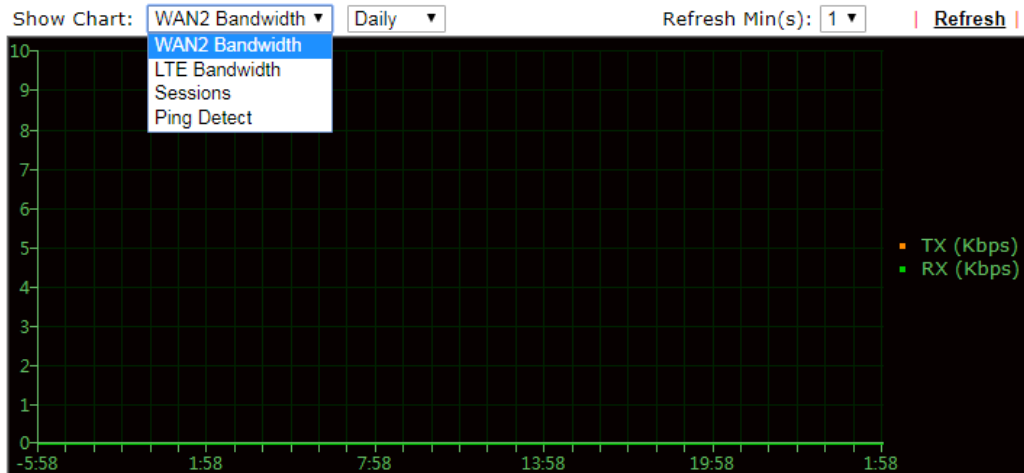

The horizontal axis represents time. Yet the vertical axis has different meanings. For WAN2/LTE Bandwidth chart, the numbers displayed on vertical axis represent the numbers of the transmitted and received packets in the past.

For Sessions chart, the numbers displayed on vertical axis represent the numbers of the NAT sessions during the past.

VIII-1-11 Trace Route

Click **Diagnostics** and click **Trace Route** to open the web page. This page allows you to trace the routes from router to the host. Simply Enter the IP address of the host in the box and click **Run**. The result of route trace will be shown on the screen.

Diagnostics >> Trace Route

Trace Route

IPV4 IPV6

Trace through: ▾

Protocol: ▾

Host / IP Address:

Result | [Clear](#) |

or

Diagnostics >> Trace Route

Trace Route

IPV4 IPV6

Trace Host / IP Address:

Result | [Clear](#) |

Available settings are explained as follows:

Item	Description
IPv4 / IPv6	Click one of them to display corresponding information for it.
Trace through	Use the drop down list to choose the interface that you want to ping through.
Protocol	Use the drop down list to choose the protocol that you want

	to ping through.
Host/IP Address	It indicates the IP address of the host.
Trace Host/IP Address	It indicates the IPv6 address of the host.
Run	Click this button to start route tracing work.
Clear	Click this link to remove the result on the window.

VIII-1-12 Syslog Explorer

Such page provides real-time syslog and displays the information on the screen.

For Web Syslog

This page displays the time and message for User/Firewall/call/WAN/VPN settings. You can check **Enable Web Syslog**, specify the type of Syslog and choose the display mode you want. Later, the event of Syslog with specified type will be shown for your reference.

Diagnostics >> Syslog Explorer

Available settings are explained as follows:

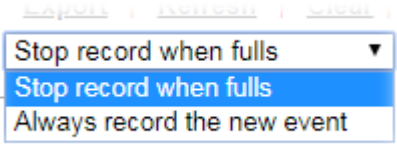
Item	Description
Enable Web Syslog	Check this box to enable the function of Web Syslog.
Syslog Type	Use the drop down list to specify a type of Syslog to be displayed. 
Export	Click this link to save the data as a file.
Refresh	Click this link to refresh this page manually.
Clear	Click this link to clear information on this page.
Display Mode	There are two modes for you to choose. 

	Stop record when fulls - When the capacity of syslog is full, the system will stop recording. Always record the new event - only the newest events will be recorded by the system.
Time	Display the time of the event occurred.
Message	Display the information for each event.

For USB Syslog

This page displays the syslog recorded on the USB storage disk.

Diagnostics >> Syslog Explorer

Web Syslog	USB Syslog
------------	------------

Note: The syslog will show while the saved syslog file size is over 1MB.

Folder: n/a File: n/a Page: n/a Log Type: n/a

Time	Log Type	Message
------	----------	---------

Available settings are explained as follows:

Item	Description
Time	Display the time of the event occurred.
Log Type	Display the type of the record.
Message	Display the information for each event.

VIII-1-13 IPv6 TSPC Status

IPv6 TSPC status web page could help you to diagnose the connection status of TSPC.

If TSPC has configured properly, the router will display the following page when the user connects to tunnel broker successfully.

Diagnostics >> IPv6 TSPC Status

WAN1	WAN2	LTE	Refresh
TSPC Disabled			

Available settings are explained as follows:

Item	Description
Refresh	Click this link to refresh this page manually.

VIII-1-14 DoS Flood Table

This page can display content of IP connection detected by DoS Flooding Defense mechanism. It is useful and convenient for network engineers (e.g., MIS engineer) to inspect the network environment to find out if there is any abnormal connection.

Information of IP traced and destination port used for SYN Flood, UDP Flood and ICMP Flood attacks will be detected and shown respectively on different pages.

Moreover, IP address detected and suspected to attack the network system can be blocked shortly by clicking the **Block** button shown on pages of SYN Flood, UDP Flood and ICMP Flood.

Diagnostics >> DoS Flood Table

IPv4

SYN Flood	UDP Flood	ICMP Flood	White/Black IP List	Refresh
Tracing IP		Destination Port		

192.168.1.22	80	Block		
192.168.1.205	40005(⊗)	Block		

IPv6

SYN Flood	UDP Flood	ICMP Flood	White/Black IP List	Refresh
Tracing IP		Destination Port		



Info

The icon - (⊗) - means there is something wrong (e.g., attacking the system) with that IP address.

However, if an IP address is confirmed to be blocked due to its abnormal behavior, click the **Blocking IP List** tab to block it forever. For example, IP address "192.168.1.123" (displayed on the following web page) will be blocked forever.

Diagnostics >> DoS Flood Table

IPv4

[SYN Flood](#)
[UDP Flood](#)
[ICMP Flood](#)
[White/Black IP List](#)
| [Refresh](#) |

IP Whitelist(Limit: 16 entries)

Add
Remove
Clear All

IP Blacklist(Limit: 16 entries)

Add
Remove
Clear All

IPv6

[SYN Flood](#)
[UDP Flood](#)
[ICMP Flood](#)
[White/Black IP List](#)
| [Refresh](#) |

IP Whitelist(Limit: 16 entries)

Add
Remove
Clear All

IP Blacklist(Limit: 16 entries)

Add
Remove
Clear All

Available settings are explained as follows:

Item	Description
White Passing IP List / Black Blocking IP List	Enter the IP address in this field and click Add . It will be added to the IP List and appear in the right frame. IP list in the right frame will be blocked by Vigor system permanently. Remove - It is used to remove selected IP address from the Blocking IP List.
Refresh	Click this link to refresh current page.

VIII-2 Checking If the Hardware Status Is OK or Not

Follow the steps below to verify the hardware status.

1. Check the power line and WLAN/LAN cable connections.
Refer to “I-2 Hardware Installation” for details.
2. Turn on the router. Make sure the **Activity LED** blink once per second and the correspondent **LAN LED** is bright.

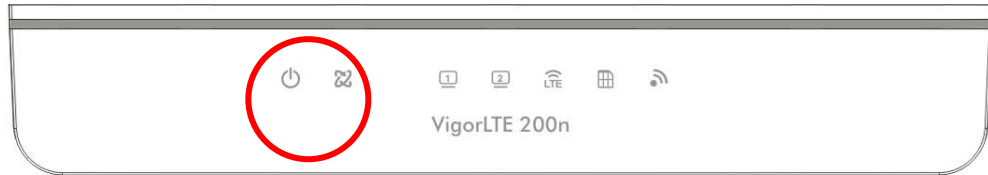

3. If not, it means that there is something wrong with the hardware status. Simply back to “I-2 Hardware Installation” to execute the hardware installation again. And then, try again.

VIII-3 Checking If the Network Connection Settings on Your Computer Is OK or Not

Sometimes the link failure occurs due to the wrong network connection settings. After trying the above section, if the link is still failed, please do the steps listed below to make sure the network connection settings is OK.

For Windows



Info

The example is based on Windows 7. As to the examples for other operation systems, please refer to the similar steps or find support notes in www.DrayTek.com.

1. Open All Programs>>Getting Started>>Control Panel. Click Network and Sharing Center.



2. In the following window, click Change adapter settings.

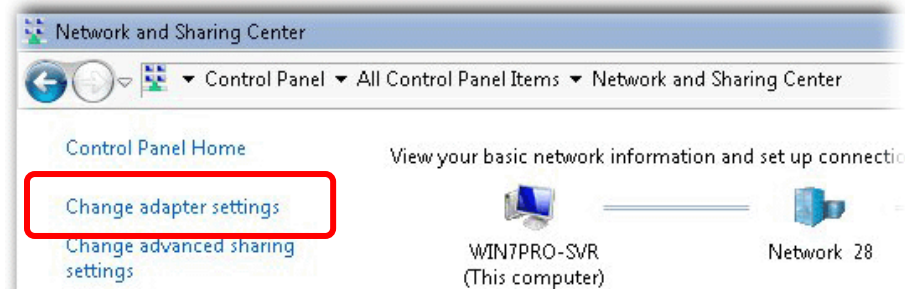

3. Icons of network connection will be shown on the window. Right-click on Local Area Connection and click on Properties.

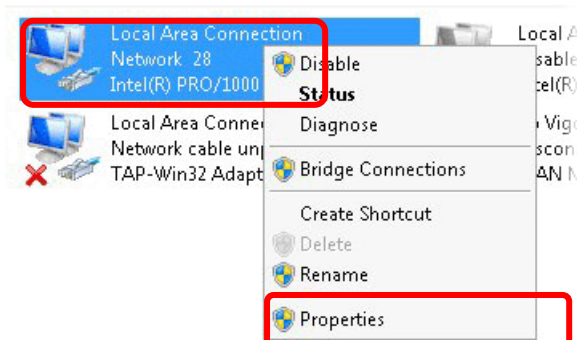

4. Select **Internet Protocol Version 4 (TCP/IP)** and then click **Properties**.

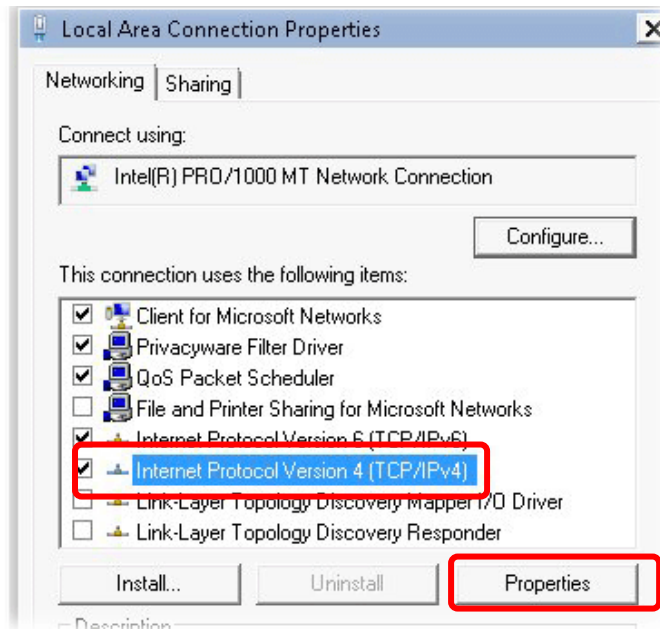

5. Select **Obtain an IP address automatically** and **Obtain DNS server address automatically**. Finally, click **OK**.

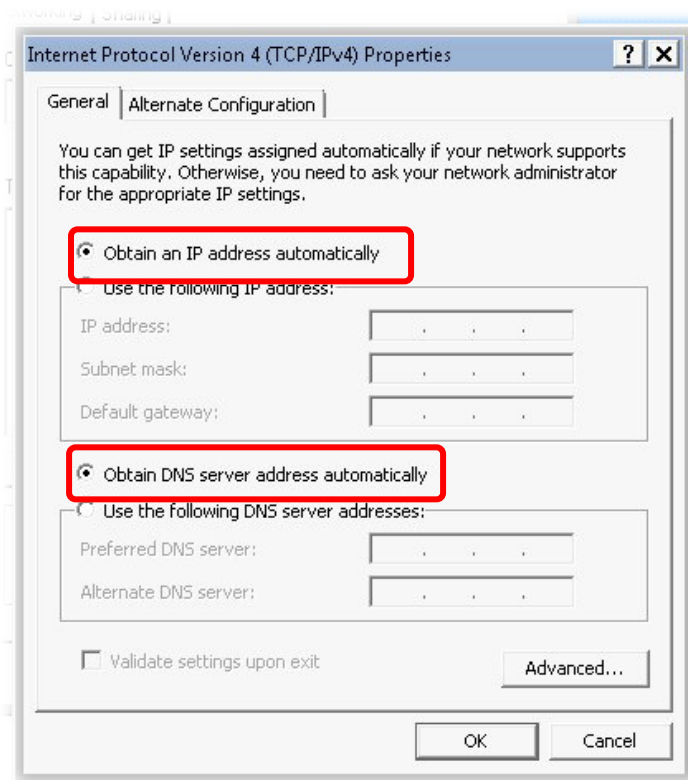

For Mac OS

1. Double click on the current used Mac OS on the desktop.
2. Open the **Application** folder and get into **Network**.
3. On the **Network** screen, select **Using DHCP** from the drop down list of Configure IPv4.

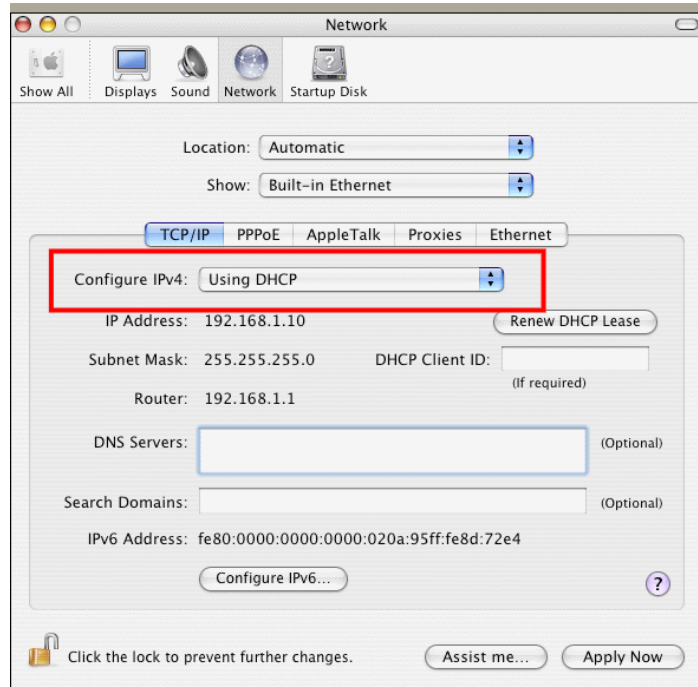

VIII-4 Pinging the Router from Your Computer

The default gateway IP address of the router is 192.168.1.1. For some reason, you might need to use “ping” command to check the link status of the router. **The most important thing is that the computer will receive a reply from 192.168.1.1.** If not, please check the IP address of your computer. We suggest you setting the network connection as get IP automatically. (Please refer to the previous section IX-3)

Please follow the steps below to ping the router correctly.

For Windows

1. Open the Command Prompt window (from Start menu> Run).
2. Type command (for Windows 95/98/ME) or cmd (for Windows NT/ 2000/XP/Vista/7). The DOS command dialog will appear.

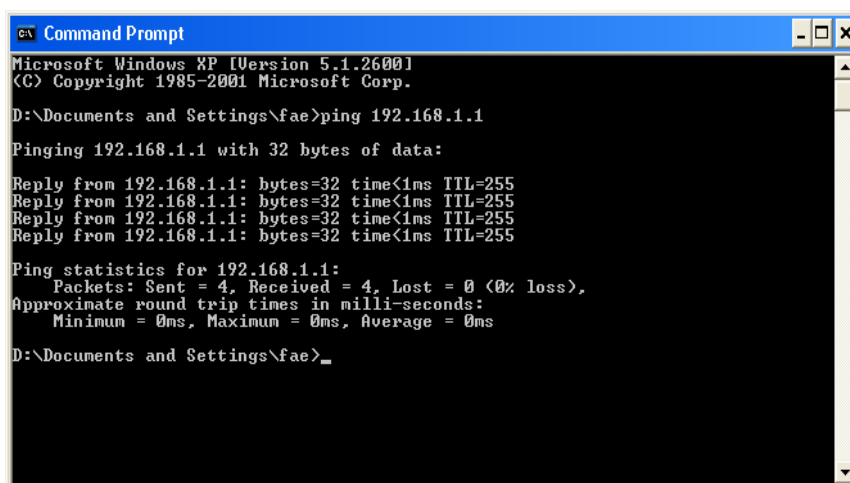

```
CA Command Prompt
Microsoft Windows XP [Version 5.1.2600]
(C) Copyright 1985-2001 Microsoft Corp.
D:\Documents and Settings\fae>ping 192.168.1.1
Pinging 192.168.1.1 with 32 bytes of data:
Reply from 192.168.1.1: bytes=32 time<1ms TTL=255
Reply from 192.168.1.1: bytes=32 time<1ms TTL=255
Reply from 192.168.1.1: bytes=32 time<1ms TTL=255
Reply from 192.168.1.1: bytes=32 time<1ms TTL=255

Ping statistics for 192.168.1.1:
    Packets: Sent = 4, Received = 4, Lost = 0 (0% loss),
    Approximate round trip times in milli-seconds:
        Minimum = 0ms, Maximum = 0ms, Average = 0ms

D:\Documents and Settings\fae>_
```

3. Type ping 192.168.1.1 and press [Enter]. If the link is OK, the line of “Reply from 192.168.1.1:bytes=32 time<1ms TTL=255” will appear.
4. If the line does not appear, please check the IP address setting of your computer.

For Mac OS (Terminal)

1. Double click on the current used MacOs on the desktop.
2. Open the Application folder and get into Utilities.
3. Double click Terminal. The Terminal window will appear.
4. Type ping 192.168.1.1 and press [Enter]. If the link is OK, the line of “64 bytes from 192.168.1.1: icmp_seq=0 ttl=255 time=xxxx ms” will appear.

```
Terminal — bash — 80x24
Last login: Sat Jan  3 02:24:18 on ttys1
Welcome to Darwin!
Vigor10:~ draytek$ ping 192.168.1.1
PING 192.168.1.1 (192.168.1.1): 56 data bytes
64 bytes from 192.168.1.1: icmp_seq=0 ttl=255 time=0.755 ms
64 bytes from 192.168.1.1: icmp_seq=1 ttl=255 time=0.697 ms
64 bytes from 192.168.1.1: icmp_seq=2 ttl=255 time=0.716 ms
64 bytes from 192.168.1.1: icmp_seq=3 ttl=255 time=0.731 ms
64 bytes from 192.168.1.1: icmp_seq=4 ttl=255 time=0.72 ms
^C
--- 192.168.1.1 ping statistics ---
5 packets transmitted, 5 packets received, 0% packet loss
round-trip min/avg/max = 0.697/0.723/0.755 ms
Vigor10:~ draytek$
```

VIII-5 Checking If the ISP Settings are OK or Not

If WAN connection cannot be up, check if the LEDs (according to the LED explanations listed on section 1.2) are correct or not. If the LEDs are off, please:

- Change the **Physical Type** from **Auto negotiation** to other values (e.g., 100M full duplex).
- Next, check if the LEDs on Vigor router are on or not.
- If not, please install an additional switch for connecting both Vigor router and the modem offered by ISP. Then, check if the LEDs on Vigor router are on or not.
- If the problem of LEDs cannot be solved by the above measures, please contact with the nearest reseller, or send an e-mail to DrayTek FAE for technical support.
- Check if the settings offered by ISP are configured well or not.

When the LEDs are on and correct, yet the WAN connection still cannot be up, please:

- Open **WAN >> Internet Access** page and then check whether the ISP settings are set correctly. Click **Details Page** of WAN1 to review the settings that you configured previously.

VIII-6 Backing to Factory Default Setting If Necessary

Sometimes, a wrong connection can be improved by returning to the default settings. Try to reset the router by software or hardware. Such function is available in **Admin Mode** only.



Info

After pressing factory default setting, you will lose all settings you did before. Make sure you have recorded all useful settings before you pressing. The password of factory default is null.

Software Reset

You can reset the router to factory default via Web page. Such function is available in **Admin Mode** only.

Go to **System Maintenance** and choose **Reboot System** on the web page. The following screen will appear. Choose **Using factory default configuration** and click **Reboot Now**. After few seconds, the router will return all the settings to the factory settings.

System Maintenance >> Reboot System

Reboot System

Do you want to reboot your router ?

- Using current configuration
- Using factory default configuration

Reboot Now

Auto Reboot Time Schedule

Schedule Profile : None ▾, None ▾, None ▾, None ▾

Note: Action and Idle Timeout settings will be ignored.

OK

Cancel

Hardware Reset

While the router is running (ACT LED blinking), press the **Factory Reset** button and hold for more than 5 seconds. When you see the ACT LED blinks rapidly, please release the button. Then, the router will restart with the default configuration.

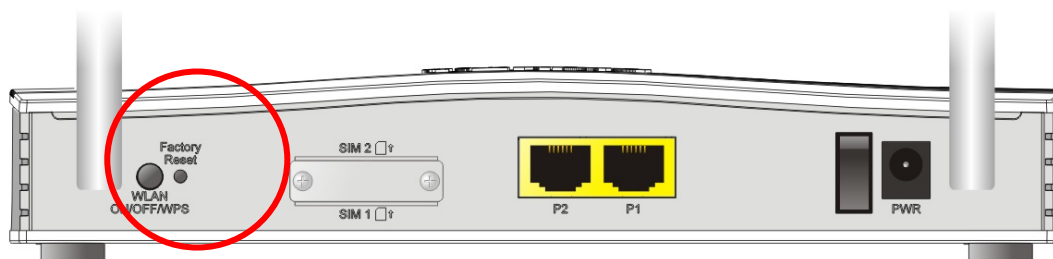

After restore the factory default setting, you can configure the settings for the router again to fit your personal request.

VIII-7 Contacting DrayTek

If the router still cannot work correctly after trying many efforts, please contact your dealer for further help right away. For any questions, please feel free to send e-mail to support@DrayTek.com.

Part IX Telnet Commands

Accessing Telnet of VigorLTE 200

This chapter also gives you a general description for accessing telnet and describes the firmware versions for the routers explained in this manual.



Info

For Windows 7 user, please make sure the Windows Features of Telnet Client has been turned on under **Control Panel>>Programs**.

Type `cmd` and press Enter. The Telnet terminal will be open later.

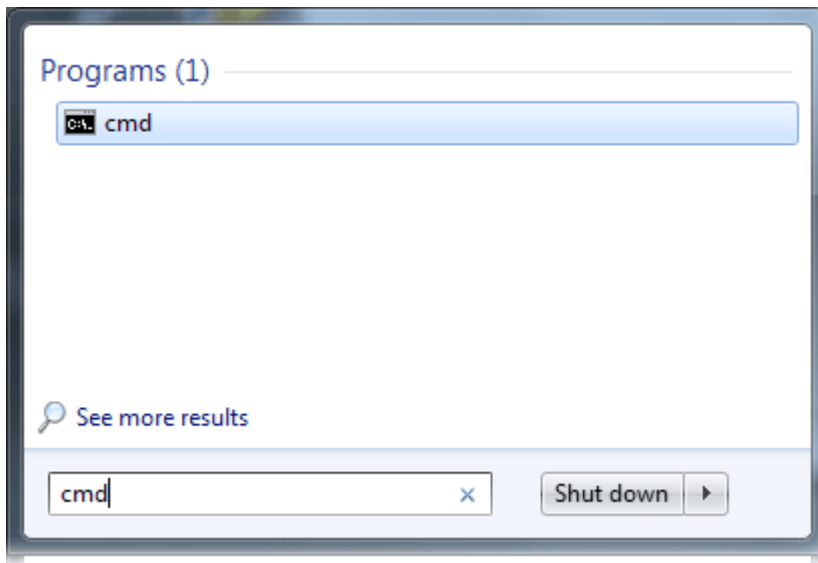

In the following window, type `Telnet 192.168.1.1` as below and press Enter. Note that the IP address in the example is the default address of the router. If you have changed the default, enter the current IP address of the router.

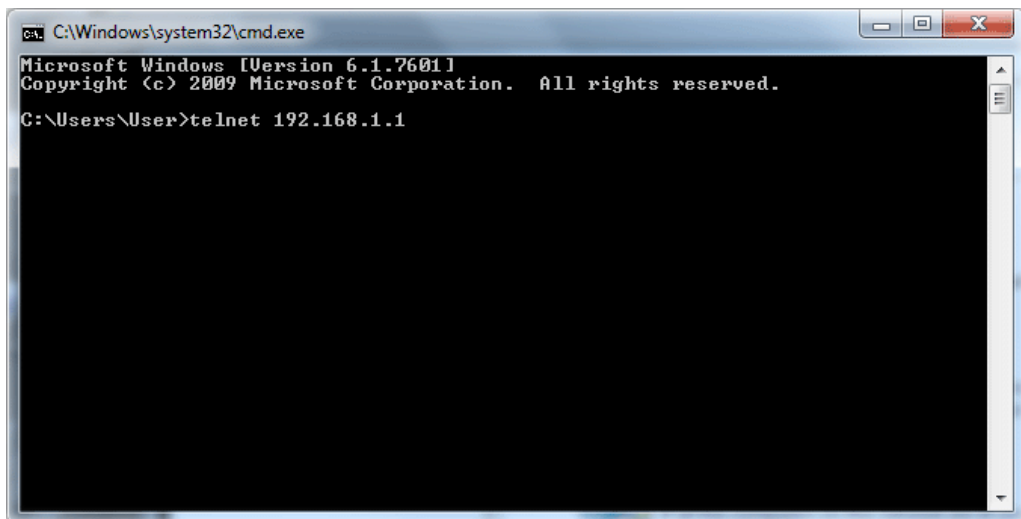

Next, type admin/admin for Account/Password. Then, type ?. You will see a list of valid/common commands depending on the router that your use.

```
ca: Telnet192.168.11
Account:admin
Password: *****
Type ? for command help
DrayTek> ?
% Valid commands are:
                                csm      ddns      dos
exit      internet      ip      ip6      ipf      log
mngt      msubnet      object  port      portmuptime  qos
quit      show      srv      switch  sys      testmail
upnp      usb      vigrbg  vlan      vpn      wan
wl      apm      ethoam
DrayTek> _
```

Telnet Command: csm appe prof

Commands under CSM allow you to set CSM profile to define policy profiles for different policy of IM (Instant Messenger)/P2P (Peer to Peer) application.

“csm appe prof “ is used to configure the APP Enforcement Profile name. Such profile will be applied in Default Rule of Firewall>>General Setup for filtering.

Syntax

```
csm appe prof -i <INDEX> <-v>
```

```
csm appe prof -i <INDEX> -n <NAME>
```

```
csm appe prof -i <INDEX> <setdefault>
```

Syntax Description

Parameter	Description
<INDEX>	It means to specify the index number of CSM profile. INDEX= 1~32.
- v	It means to view the configuration of the CSM profile.
- n <NAME>	It means to set a name for the CSM profile. <NAME>: Specify a name for the CSM profile, less then 15 characters.
setdefault	Reset to default settings.

Example

```
> csm appe prof -i 1 -n game
The name of APPE Profile 1 was setted.

> csm appe prof -i 1 setdefault
APPE Profile 1 was reseted.
```

Telnet Command: csm appe set

It is used to configure group settings for IM/P2P/Protocol and Others in APP Enforcement Profile.

```
csm appe set -i INDEX -v <GROUP>
```

```
csm appe set -i INDEX -e <AP_IDX>
```

```
csm appe set -i INDEX -d <AP_IDX>
```

Syntax Description

Parameter	Description
<INDEX>	It means to specify the index number of CSM profile. INDEX= 1~32.
- v <GROUP>	View the IM/P2P/Protocol or Others configuration of the CSM profile. <GROUP>= IM, P2P, Protocol,or Others.
-e	Enable to block specific application.
-d	Disable to block specific application.

<code><AP_IDX></code>	Specify the index number of the application here. AP_IDX=1-119
-----------------------------	---

Example

```
> csm appe set -i 1 -e 1
Profile 1 - : AIM is enabled.
> csm appe set -i 32 -e 90
Profile 32 - : PPTV is enabled.
```

Telnet Command: csm appe show

It is used to display group (IM/P2P/Protocol and Others) information APP Enforcement Profile.

`csm appe show <-a/-i/-p/-t/-m>`

Syntax Description

Parameter	Description
<code>-a</code>	View the configuration status for All groups.
<code>-i</code>	View the configuration status of IM group.
<code>-p</code>	View the configuration status of P2P group.
<code>-t</code>	View the configuration status of protocol group.
<code>-m</code>	View the configuration status of Others group.

Example

```
>csm appe show -t

      Type      Index      Name      Version  Advance
Advanced Option: (M)essage, (F)ile Transfer, (G)ame, (C)onference, and (O)ther
Activities
-----
PROTOCOL      52      DB2
PROTOCOL      53      DNS
PROTOCOL      54      FTP
PROTOCOL      55      HTTP      1.1
PROTOCOL      56      IMAP      4.1
PROTOCOL      57      IMAP STARTTLS      4.1
PROTOCOL      58      IRC      2.4.0      .....
```

Telnet Command: csm appe config

It is used to display the configuration status (enabled or disabled) for IM/P2P/Protocol/Other applications.

`csm appe config -v <INDEX><-i/-p/-t/-m>`

Syntax Description

Parameter	Description
<code><INDEX></code>	It means to specify the index number of CSM profile. INDEX= 1~32.
<code>-i</code>	View the configuration status of IM group.
<code>-p</code>	View the configuration status of P2P group.

<i>-t</i>	View the configuration status of protocol group.
<i>-m</i>	View the configuration status of Others group.

Example

```
> csm appe config -v 1 -m

      Group      Type      Index      Name      Enable      A
vance Enable
Advance abbreviation: Message, File Transfer, Game, Conference, and Other
Advance abbreviation: : M, F, G, C, and O
-----
OTHERS      TUNNEL      75      DNSCrypt      Disable
OTHERS      TUNNEL      76      DynaPass      Disable
OTHERS      TUNNEL      77      FreeU      Disable
OTHERS      TUNNEL      78      HTTP Proxy      Disable
OTHERS      TUNNEL      79      HTTP Tunnel      Disable
OTHERS      TUNNEL      80      Hamachi      Disable
OTHERS      TUNNEL      81      Hotspot Shield      Disable
OTHERS      TUNNEL      82      MS Teredo      Disable
OTHERS      TUNNEL      83      PGPNet      Disable
OTHERS      TUNNEL      84      Ping Tunnel      Disable
.
.
.
-----
Total 66 APPs
>
```

Telnet Command: csm ucf

It is used to configure settings for URL control filter profile.

Syntax

```
csm ucf show
csm ucf setdefault
csm ucf msg MSG
csm ucf obj <INDEX> -n <PROFILE_NAME> -I <P/B/A> <uac>< wf>
csm ucf obj <INDEX> -n <PROFILE_NAME>
csm ucf obj <INDEX> -p <VALUE>
csm ucf obj <INDEX> <-I P/B/A>
csm ucf obj <INDEX> uac
csm ucf obj <INDEX> wf
```

Syntax Description

Parameter	Description
<i>show</i>	It means to display all of the profiles.
<i>setdefault</i>	It means to return to default settings for all of the profile.
<i>msg MSG</i>	It means de set the administration message. MSG means the content (less than 255 characters) of the message itself.
<i>obj</i>	It means to specify the object for the profile.
<INDEX>	It means to specify the index number of CSM profile. INDEX= 1~8.
<i>-n <PROFILE_NAME></i>	It means to set the profile name. PROFILE_NAME: Enter the name of the profile (less than 16

	characters).
<i>-p</i> <VALUE>	Set the priority (defined by the number specified in VALUE) for the profile. Number 0 to 3 represent different conditions. VALUE=0: It means Bundle: Pass. VALUE=1: It means Bundle: Block. VALUE=2: It means Either: URL Access Control First. VALUE=3: It means Either: Web Feature First.
<i>-l</i> <P/B/A>	It means the log type of the profile. They are: P: Pass, B: Block, A: All
<i>uac</i>	It means to set URL Access Control part.
<i>wf</i>	It means to set Web Feature part.

Example

```
> csm ucf obj 1 -n game -l B
Profile Index: 1   Profile Name:[game]
```

Telnet Command: csm ucf obj INDEX uac

It means to configure the settings regarding to URL Access Control (uac).

Syntax

```
csm ucf obj <INDEX> uac -v
csm ucf obj <INDEX> uac -e
csm ucf obj <INDEX> uac -d
csm ucf obj <INDEX> uac -a <P/B>
csm ucf obj <INDEX> uac -i <E/D>
csm ucf obj <INDEX> uac -o <KEY_WORD_Object_Index>
csm ucf obj <INDEX> uac -g <KEY_WORD_Group_Index>
```

Syntax Description

Parameter	Description
<INDEX>	It means to specify the index number of CSM profile. INDEX= 1~8.
<i>-v</i>	It means to view the protocol configuration of the CSM profile.
<i>-e</i>	It means to enable the function of URL Access Control.
<i>-d</i>	It means to disable the function of URL Access Control.
<i>-a</i> <P/B>	Set the action of specific application, P or B. B: Block. The web access meets the URL Access Control will be blocked. P: Pass. The web access meets the URL Access Control will be passed.
<i>-i</i> <E/D>	Prevent the web access from any IP address. E: Enable the function. The Internet access from any IP address will be blocked.

	D: Disable the function.
-o < KEY_WORD_Object_Index>	Set the keyword object. KEY_WORD_Object_Index: Specify the index number of the object profile.
-g < KEY_WORD_Group_Index>	Set the keyword group. KEY_WORD_Group_Index: Specify the index number of the group profile.

Example

```

> csm ucf obj 1 uac -i E
Log:[none]
Priority Select : [Bundle : Pass]
-----
URL Access Control
[ ]Enable URL Access Control   Action:[pass]
[v]Prevent web access from IP address.
  No  Obj NO.   Object Name
-----

  No  Grp NO.   Group Name
-----
> csm ucf obj 1 uac -a B
Log:[none]
Priority Select : [Bundle : Pass]
-----
URL Access Control
[ ]Enable URL Access Control   Action:[block]
[v]Prevent web access from IP address.
  No  Obj NO.   Object Name
-----

  No  Grp NO.   Group Name
-----

```

Telnet Command: csm ucf obj INDEX wf

It means to configure the settings regarding to Web Feature (wf).

Syntax

```
csm ucf obj <INDEX> wf -v
csm ucf obj <INDEX> wf -e
csm ucf obj <INDEX> wf -d
csm ucf obj <INDEX> wf -a <P/B>
csm ucf obj <INDEX> wf -s <WEB_FEATURE>
csm ucf obj <INDEX> wf -u <WEB_FEATURE>
csm ucf obj <INDEX> wf -f <File_Extension_Object_index>
```

Syntax Description

Parameter	Description
<INDEX>	It means to specify the index number of CSM profile. INDEX= 1~8.
-v	It means to view the protocol configuration of the CSM profile.
-e	It means to enable the restriction of web feature.
-d	It means to disable the restriction of web feature.
-a <P/B>	Set the action of web feature, P or B. B: Block. The web access meets the web feature will be blocked. P: Pass. The web access meets the web feature will be passed.
-s <WEB_FEATURE>	It means to enable the the Web Feature configuration. Features available for configuration are: <WEB_FEATURE>=c: Cookie <WEB_FEATURE>=p: Proxy <WEB_FEATURE>=u: Upload
-u <WEB_FEATURE>	It means to cancel the web feature configuration.
-f <File_Extension_Object_index>	It means to set the file extension object index number. File_Extension_Object_index=1 to 8

Example

```
> csm ucf obj 1 wf -s c
-----
Web Feature
[ ]Enable Restrict Web Feature   Action:[pass]

File Extension Object Index : [0] Profile Name : []

[V] Cookie [ ] Proxy [ ] Upload
```

Telnet Command: csm wcf

It means to configure the settings regarding to web control filter (wcf).

Syntax

```
csm wcf show
csm wcf look
csm wcf cache
csm wcf server WCF_SERVER
csm wcf msg MSG
csm wcf setdefault
csm wcf obj <INDEX> -v
csm wcf obj <INDEX> -a <P/B>
csm wcf obj <INDEX> -n <PROFILE_NAME>
csm wcf obj <INDEX> -l <N/P/B/A>
csm wcf obj <INDEX> -o <KEY_WORD Object Index>
csm wcf obj <INDEX> -g <KEY_WORD Group Index>
csm wcf obj <INDEX> -w <E/D/P/B>
csm wcf obj <INDEX> -s <CATEGORY/WEB_GROUP>
csm wcf obj <INDEX> -u <CATEGORY/WEB_GROUP>
```

Syntax Description

Parameter	Description
<i>show</i>	It means to display the web content filter profiles.
<i>look</i>	It means to display the license information of WCF.
<i>cache</i>	It means to set the cache level for the profile.
<i>server</i> WCF_SERVER	It means to set web content filter server.
<i>msg</i> MSG	It means de set the administration message. MSG means the content (less than 255 characters) of the message itself.
<i>setdefault</i>	It means to return to default settings for all of the profile.
<i>obj</i>	It means to specify the object profile.
<INDEX>	It means to specify the index number of CSM profile. INDEX= 1~8.
-v	It means to view the web content filter profile.
-a <P/B>	Set the action of web content filter profile, P or B. B: Block. The web access meets the web feature will be blocked. P: Pass. The web access meets the web feature will be passed.
-n <PROFILE_NAME>	It means to set the profile name. PROFILE_NAME: Enter the name of the profile (less than 16 characters)
-l <N/P/B/A>	It means the log type of the profile. They are: P: Pass, B: Block, A: All, N: None
-o <KEY_WORD Object Index>	Set the keyword object. <KEY_WORD Object Index>= Specify the index number of the object profile.
-g <KEY_WORD Group Index>	Set the keyword group. <KEY_WORD Group Index>= Specify the index number of the group profile.
-w <E/D/P/B>	It means to set the action for the black and white list. E: Enable, D: Disable, P: Pass, B: Block

<p>-s <CATEGORY/WEB_GROUP></p>	<p>It means to select the items under CATEGORY or WEB_GROUP. <WEB_GROUP>: Includes "Child Protection Group", "Leisure Group", "Business Group", "Chating Group", "Computer Internet Group", "Other Group" <CATEGORY>: Includes "Advertisement & Pop-Ups", "Alcohol & Tobacco", "Anonymizers", "Arts", "Business", "Transportation", "Chat", "Forums & Newsgroups", "Compromised", "Computers & Technology", "Criminal & Activity", "Dating & Personals", "Down sites", "Education", "Entertainment", "Finance", "Gambling", "Games", "Government", "Hate & Intolerance", "Health & Medicine", "Illegal Drug", "Job Search", "Streaming Media & Downloads", "News", "Non-profits & NGOs", "Nudity", "Persional Sites", "Phishing & Fraud", "Politics", "Pornography & Sexually explicit", "Real Estate", "Religion", "Restaurants & Dining", "Search engines & Portals", "Shopping", "Social Networking", "Spam sites", "Sports", "Malware", "Translators", "Travel", "Violence", "Weapons", "Web-Based Email", "General", "Leisure & Recreation", "Botnets", "Cults", "Fashion & Beauty", "Greeting Cards", "Hacking", "Illegal Softwares", "Image Sharing", "Information Security", "Instant Messaging", "Network Errors", "Parked Domains", "Peer-to-Peer", "Private IP Address", "School Cheating", "Sex Education", "Tasteless", "Child Abuse Images", "Uncategorised Sites"</p>
<p>-u <CATEGORY/WEB_GROUP></p>	<p>It means to discard items under CATEGORY or WEB_GROUP. <WEB_GROUP>: Includes "Child Protection Group", "Leisure Group", "Business Group", "Chating Group", "Computer Internet Group", "Other Group" <CATEGORY>: Includes "Advertisement & Pop-Ups", "Alcohol & Tobacco", "Anonymizers", "Arts", "Business", "Transportation", "Chat", "Forums & Newsgroups", "Compromised", "Computers & Technology", "Criminal & Activity", "Dating & Personals", "Down sites", "Education", "Entertainment", "Finance", "Gambling", "Games", "Government", "Hate & Intolerance", "Health & Medicine", "Illegal Drug", "Job Search", "Streaming Media & Downloads", "News", "Non-profits & NGOs", "Nudity", "Persional Sites", "Phishing & Fraud", "Politics", "Pornography & Sexually explicit", "Real Estate", "Religion", "Restaurants & Dining", "Search engines & Portals", "Shopping", "Social Networking", "Spam sites", "Sports", "Malware", "Translators", "Travel", "Violence", "Weapons", "Web-Based Email", "General", "Leisure & Recreation", "Botnets", "Cults", "Fashion & Beauty", "Greeting Cards", "Hacking", "Illegal Softwares", "Image Sharing", "Information Security", "Instant Messaging", "Network Errors", "Parked Domains", "Peer-to-Peer", "Private IP Address", "School Cheating", "Sex Education", "Tasteless", "Child Abuse Images", "Uncategorised Sites"</p>

Example

```
> csm wcf obj 1 -n test_wcf
Profile Index: 1
Profile Name:[test_wcf]
[ ]White/Black list
Action:[block]
  No  Obj NO.   Object Name
-----
  No  Grp NO.   Group Name
-----
Action:[block]
Log:[block]
-----
child Protection Group:
[]Alcohol & Tobacco      []Criminal & Activity      []Gambling
[]Hate & Intolerance      []Illegal Drug            []Nudity
[]Pornography & Sexually explicit []Violence                []Weapons
[]School Cheating        []Sex Education          []Tasteless
[]Child Abuse Images
-----
leisure Group:
[ ]Entertainment      [ ]Games              [ ]Sports
[ ]Travel              [ ]Leisure & Recreation [ ]Fashion & Beauty
.
.
>
```

Telnet Command: ddns log

Displays the DDNS log.

Example

```
>ddns log
>
```

Telnet Command: ddns enable

Enables or disables the DDNS function.

Syntax

ddns enable <0/1>

Syntax Description

Parameter	Description
<0/1>	0 - Disable the DDNS function. 1 - Enable the DDNS function.

Example

```
> ddns enable 1
> Enable Dynamic DNS Setup
```

Telnet Command: ddns set

This command allows users to set Dynamica DNS account.

Syntax

ddns set *option* <value>

Syntax Description

Parameter	Description
-i <value>	It means index number of Dynamic DNS Account. <value>=1~6
-E <value>	It means to enable /disable Dynamic DNS Account. <value>=0~1 0: Disable 1: Enable
-W <value>	It means to specify WAN Interface. <value>=1~4 1: WAN1 First 2: WAN1 Only 3: WAN2 First 4: WAN2 Only example: To set WAN Interface: WAN1 First
-L <value>	It means to type Login Name. [value]: limit up to 64 characters
-P <value>	It means to type Password. [value]: limit up to 24 characters
-C <value>	It means to enable /disable Wildcards. <value>=0~1 0: Disable 1: Enable
-B <value>	It means to enable / disable Backup MX. <value>=0~1 0: Disable 1: Enable
-M <value>	It means to type Mail Extender. [value]: limit up to 60 characters
-R <value>	It means to type Determine Real WAN IP. <value>=0~1 0: WAN IP, 1: Internet IP
-S <value>	It means to specify Servive Provider. If user want to set User-Defined page, value must select 1. <value>= 1~19 1: User-Defined 2: 3322 DDNS (www.3322.org) 3: ChangeIP.com (www.changeip.com) 4: ddns.com.cn (www.ddns.com.cn) 5: DtDNS (www.dtdns.com) 6: dyn.com (www.dyn.com) 7: DynAccess (www.dynaccess.com) 8: dynami.co.za (www.dynami.co.za) 9: freedns.afraid.org (freedns.afraid.org) 10: NO-IP.COM Free (www.no-ip.com) 11: opendns.com (www.opendns.com) 12: OVH (www.ovh.com) 13: Strato (www.strato.eu) 14: TwoDNS (www.twodns.de) 15: TZO (www.tzo.com) 16: ubddns.org (ubddns.org)

	17: Viettel DDNS (vddns.vn) 18: vigorddns.com (www.vigorddns.com) 19: ZoneEdit DDNS (dynamic.zoneedit.com)
<i>T</i> <value>	It means to type Service Type. <value>= 1~3 1: Dynamic 2: Custom 3: Static
<i>-D</i> <Host Name> <sub Domain Name>	It means to type Domain Name. i.e: Account index 1 setting Domain Name for Dynamic Service Type >> ddns set -i 1 -T 1 -D "host ddns.com.cn" i.e: Account index 2 setting Domain Name for Custom Service Type >> ddns set -i 2 -T 2 -D "domain name" i.e: Account index 3 setting Domain Name for Static Service Type >> ddns set -i 3 -T 3 -D "domain name"
<i>-H</i> <value>	It means to type User-Defined Provider Host. <value>= limit up to 64 characters
<i>-A</i> <value>	It means to type User-Defined Service API. <value>= limit up to 256 characters
<i>-a</i> <value>	It means to type User-Defined Auth Type. <value>=0-1 0: basic 1: URL
<i>-N</i> <value>	It means to type User-Defined Connection Type. <value>=0-1 0: Http 1: Https
<i>-O</i> <value>	It means to type User-Defined Server Response. <value>: limit up to 32 characters

Example

```
> ddns set -i 1 -S 6 -T 1 -D "hostname dnsalias.net" -L user1 -P pwd1
> Save OK
```

Telnet Command: ddns time

Sets and displays the DDNS time.

Syntax

ddns time <update in minutes>

Syntax Description

Parameter	Description
<i>update in minutes</i>	Enter the value as DDNS time. <update in minutes>=1 ~ 1440.

Example

```
> ddns time
ddns time <update in minutes>
Valid: 1 ~ 1440
%Now: 1440
```



```
> ddns time 1000
ddns time <update in minutes>
Valid: 1 ~ 1440
%Now: 1000
```

Telnet Command: ddns forceupdate

This command will update DDNS automatically.

Example

```
> ddns forceupdate
Now updating DDNS ...
Please check result by using command "ddns log"
```

Telnet Command: ddns setdefault

This command will return DDS with factory default settings.

Example

```
>ddns setdefault
>Set to Factory Default.
```

Telnet Command: ddns show

This command allows users to check the content of selected DDNS account.

Syntax

ddns show -i <value>

Syntax Description

Parameter	Description
-i <value>	Display the content of selected DDNS account by entering the index number of the account. <value>=1~6

Example

```
> ddns show -i 1
-----
Index: 1
[ ] Enable Dynamic DNS Account
WAN Interface: WAN1 First
Service Provider: dyn.com (www.dyn.com)
Service Type: Dynamic
Domain Name: [].[]
Login Name:
[ ] Wildcards
[ ] Backup MX
Mail Extender:
Determine Real WAN IP: WAN IP

DrayTek>
```

Telnet Command: dos

This command allows users to configure the settings for DoS defense system.

Syntax

```
dos <-V / D / A>
dos -s <ATTACK_F> <THRESHOLD> <TIMEOUT>
dos <-a /-e> <ATTACK_F><ATTACK_0>
dos -d <ATTACK_F><ATTACK_0>
dos -o <LOG_TYPE> -p<LOG_TYPE> -l <LOG_TYPE>
dos <-P/-B> add4 <ipv4_addr>
dos <-P/-B> remove4 <ipv4_addr/all>
dos <-P/-B> add6 <ipv6_addr>
dos <-P/-B> remove6 <ipv6_addr/all>
dos <-P/-B> show
```

Syntax Description

Parameter	Description
-V	It means to view the configuration of DoS defense system.
-D	It means to deactivate the DoS defense system.
-A	It means to activate the DoS defense system.
-s <ATTACK_F> <THRESHOLD> <TIMEOUT>	It means to enable the defense function for a specific attack and set its parameter(s). <ATTACK_F>: Specify the name of flooding attack(s) or portscan, e.g., synflood, udpflood, icmpflood, or postscan. <THRESHOLD>: It means the packet rate (packet/second) that a flooding attack will be detected. Set a value larger than 20. <TIMEOUT>: It means the time (seconds) that a flooding attack will be blocked. Set a value larger than 5.
-a <ATTACK_F> <ATTACK_0>	It means to enable the defense function for all attacks listed in ATTACK_0. <ATTACK_F>: Specify the name of flooding attack(s) or portscan, e.g., synflood, udpflood, icmpflood, or postscan. <ATTACK_0>: Specify a name of the following attacks: ip_option, tcp_flag, land, teardrop, smurf, pingofdeath, traceroute, icmp_frag, syn_frag, unknow_proto, fraggle.
-e <ATTACK_F> <ATTACK_0>	It means to enable defense function for a specific attack(s). <ATTACK_F>: Specify the name of flooding attack(s) or portscan, e.g., synflood, udpflood, icmpflood, or postscan. <ATTACK_0>: Specify a name of the following attacks: ip_option, tcp_flag, land, teardrop, smurf, pingofdeath, traceroute, icmp_frag, syn_frag, unknow_proto, fraggle.
-d <ATTACK_F> <ATTACK_0>	It means to disable the defense function for a specific attack(s). <ATTACK_F>: Specify the name of flooding attack(s) or portscan, e.g., synflood, udpflood, icmpflood, or postscan. <ATTACK_0>: Specify a name of the following attacks:

	ip_option, tcp_flag, land, teardrop, smurf, pingofdeath, traceroute, icmp_frag, syn_frag, unknow_proto, fraggle.
<i>-o</i> <LOG_TYPE>	It means to enable/disable DOS defense log. <LOG_TYPE>= 0-1 0:Disable 1:Enable
<i>-p</i> <LOG_TYPE>	It means to enable/disable spoofing defense log. <LOG_TYPE>= 0-1 0:Disable 1:Enable
<i>-l</i> <LOG_TYPE>	It means to enable/disable black and white list log. <LOG_TYPE>= 0-3 0:None 1:WhiteList 2:BlackList 3:All
<i><-P/-B> add4</i> <ipv4_addr>	It means to set Passing List or Blocking List. <ipv4_addr>= Enter an IPv4 address.
<i><-P/-B> remove4</i> <i><ipv4_addr/all></i>	It means to remove IPv4 address in Passing List or Blocking List. <ipv4_addr/all>= Enter an IPv4 address or enter all.
<i><-P/-B> add6</i> <ipv6_addr>	It means to add an IPv6 address to Passing List or Blocking List. <ipv6_addr>= Enter an IPv6 address.
<i><-P/-B> remove6</i> <i><ipv6_addr/all></i>	It means to remove IPv6 address in Passing List or Blocking List. <ipv6_addr/all>= Enter an IPv6 address or enter all.
<i><-P/-B> show</i>	It means to show the Passing List or Blocking List.

Example

```
>dos -A
The Dos Defense system is Activated
>dos -s synflood 50 10
Synflood is enabled! Threshold=50 <pke/sec> timeout=10 <pke/sec>
DrayTek> dos -P add4 192.168.1.59
Add IP in Passing IP List success.
```

Telnet Command: exit

Type this command will leave telnet window.

Telnet Command: Internet

This command allows you to configure detailed settings for WAN connection.

Syntax

internet -<command> <parameter> / ...

Syntax Description

Parameter	Description
<i><command><parameter>/...]</i>	The available commands with parameters are listed below. [...] means that you can Enter several commands in one line.
<i>-M <n></i>	M means to set Internet Access Mode (Mandatory) and n means different modes (represented by 0 - 3) n=0: Offline n=1: PPPoE n=2: Dynamic IP n=3: Static IP n=A: 3G/4G USB Modem(PPP mode) n=B: 3G/4G USB Modem(DHCP mode)
<i>-S <isp name></i>	It means to set ISP Name (max. 23 characters).
<i>-P <on/off></i>	It means to enable PPPoE Service.
<i>-u <username></i>	It means to set username (max. 49 characters) for Internet accessing.
<i>-p <password></i>	It means to set password (max. 49 characters) for Internet accessing.
<i>-a <n></i>	It means to set PPP Authentication Type and n means different types (represented by 0-1). n=0: PAP/CHAP (this is default setting) n=1: PAP Only
<i>-t <n></i>	It means to set connection duration and n means different conditions. n=1~999: Idle time for offline (default 180 seconds) n=-1: Always-on
<i>-i <ip address></i>	It means that <i>PPPoE server</i> will assign an IP address specified here for CPE (PPPoE client). If you type 0.0.0.0 as the <i><ip address></i> , ISP will assign suitable IP address for you. However, if you type an IP address here, the router will use that one as a fixed IP.
<i>-w <ip address></i>	It means to assign WAN IP address for such connection. Please type an IP address here for WAN port.
<i>-n <netmask></i>	It means to assign netmask for WAN connection. You have to type 255.255.255.xxx (x is changeable) as the netmask for WAN port.
<i>-g <gateway></i>	It means to assign gateway IP for such WAN connection.
<i>-A <idx></i>	Set to Always On mode, and <i><idx></i> as backup WAN#.
<i>-B <mode></i>	Set to Backup mode; <i><mode></i> 0: When any WAN disconnect; 1: When all WAN disconnect.
<i>-V</i>	It means to view Internet Access profile.
<i>-C <sim pin code></i>	Set SIM PIN code (max. 15 characters) for USB PPP mode.
<i>-O <init string></i>	Set Modem Initial String (max. 47 characters) for USB PPP mode.
<i>-T <init string2></i>	Set Modem Initial String2 (max. 47 characters) for USB PPP mode.

<i>-D <dial string></i>	Set Modem Dial String (max. 31 characters) for USB PPP mode.
<i>-v <service name></i>	Set Service Name (max. 23 characters) for USB PPP mode.
<i>-m <ppp username></i>	Set PPP Username (max. 63 characters) for USB PPP mode.
<i>-o <ppp password></i>	Set PPP Password (max. 62 characters) for USB PPP mode.
<i>-e <n></i>	Set PPP Authentication Type for USB PPP mode. n= 0: PAP/CHAP (default) 1: PAP Only
<i>-q <n></i>	Set the first schedule for USB PPP mode. n=1~15
<i>-x <n></i>	Set the second schedule for USB PPP mode. n=1~15
<i>-y <n></i>	Set the third schedule for USB PPP mode. n=1~15
<i>-z <n></i>	Set the fourth schedule for USB PPP mode. n=1~15
<i>-Q <mode></i>	Set (PPP mode or DHCP mode) WAN Connection Detection Mode. <mode> 0: ARP Detect; 1: Ping Detect
<i>-I <ping ip></i>	Set (PPP mode or DHCP mode) WAN Connection Detection Ping IP for USB DHCP or PPP mode. <ping ip>= ppp.qqq.rrr.sss: WAN Connection Detection Ping IP
<i>-L <n></i>	Set WAN Connection Detection TTL (1-255) value for USB PPP mode. N=1~255
<i>-E <sim pin code></i>	Set SIM PIN code (max. 19 characters) for USB DHCP mode.
<i>-G <mode></i>	Set Network Mode for USB DHCP mode. <mode> 0: 4G/3G/2G; 1: 4G Only; 2: 3G Only; 3: 2G Only
<i>-N <apn name></i>	Set APN Name (max. 47 characters) for USB DHCP mode.
<i>-U <n></i>	Set MTU(1000-1440) for USB DHCP mode. n=1000~1440
<i>-f <n></i>	Set DSL Mode. n= 0: Auto, n=1: ADSL Only, n=2: VDSL Only
<i>-j <on/off></i>	Separate Account for ADSL. on: enable. off: disable.

<code>-k <username></code>	Set ADSL account Username (max. 49 characters) when Separate Account is enabled.
<code>-l <password></code>	Set ADSL account Password (max. 49 characters) when Separate Account is enabled.

Example

```

>internet -M 1 -S tcom -u username -p password -a 0 -t -1 -i 0.0.0.0
WAN1 Internet Mode set to PPPoE/PPPoA
WAN1 ISP Name set to tcom
WAN1 Username set to username
WAN1 Password set successful
WAN1 PPP Authentication Type set to PAP/CHAP
WAN1 Idle timeout set to always-on
WAN1 Gateway IP set to 0.0.0.0
> internet -V
WAN1 Internet Mode:PPPoE
ISP Name: tcom
Username: username
Authentication: PAP/CHAP
Idle Timeout: -1
WAN IP: Dynamic IP
> internet -M 1 -u link1 -p link1 -a 0
WAN1 Internet Mode set to PPPoE/PPPoA
WAN1 Username set to link1
WAN1 Password set successful
WAN1 PPP Authentication Type set to PAP/CHAP

```

Telnet Command: ip pubsubnet

This command allows users to enable or disable the public subnet for your router.

Syntax

`ip pubsubnet <Enable/Disable>`

Syntax Description

Parameter	Description
<code><Enable/Disable></code>	Enable or disable the function.

Example

```

> ip pubsubnet enable
public subnet enabled!

```

Telnet Command: ip pubaddr

This command allows to set the IP routed subnet for the router.

Syntax

`ip pubaddr ?`

`ip pubaddr <public subnet IP address>`

Syntax Description

Parameter	Description
?	Display current IP address which allows users set as the public subnet IP address.
<public subnet IP address>	Specify an IP address. The system will set the one that you specified as the public subnet IP address.

Example

```
> ip pubaddr ?
% ip addr <public subnet IP address>
% Now: 192.168.0.1

> ip pubaddr 192.168.2.5
% Set public subnet IP address done !!!
```

Telnet Command: ip pubmask

This command allows users to set the mask for IP routed subnet of your router.

Syntax

ip pubmask ?

ip pubmask <public subnet mask>

Syntax Description

Parameter	Description
?	Display current IP address which allows users set as the public subnet mask.
<public subnet IP address>	Specify a subnet mask. The system will set the one that you specified as the public subnet mask.

Example

```
> ip pubmask ?
% ip pubmask <public subnet mask>
% Now: 255.255.255.0

> ip pubmask 255.255.0.0
% Set public subnet mask done !!!
```

Telnet Command: ip aux

This command is used for configuring WAN IP Alias.

Syntax

ip aux add <IP> <Join to NAT Pool>

ip aux remove <index>

Syntax Description

Parameter	Description
add <IP> <Join to NAT Pool>	It means to create a new WAN IP address. <IP>=Enter an IP address as the auxiliary WAN IP address.

	<Join to NAT Pool>=0-1, 0 (disable) or 1 (enable).
<i>remove</i> < index >	It means to delete an existed WAN IP address. <index>= Enter the index number of the table displayed on your screen.

Example

```

> ip aux add 192.168.1.65 1
% 192.168.1.65 has added in index 2.

DrayTek> ip aux ?
%% ip aux add [IP] [Join to NAT Pool]
%% ip aux remove [Index]

%%      Where IP = Auxiliary WAN IP Address.
%%      Join to NAT Pool = 0 or 1.
%%      Index = The Index number of table.

Now auxiliary WAN1 IP Address table:
Index no.      Status  IP address      NAT IP pool
-----
  1             Disable 0.0.0.0 Yes
  2             Enable 192.168.1.65   Yes

```

Telnet Command: ip addr

This command allows users to set/add a specified LAN IP your router.

Syntax

ip addr <IP address>

Syntax Description

Parameter	Description
<IP address>	It means the LAN IP address. <IP address>=Enter an IPv4 address.

Example

```
>ip addr 192.168.50.1
% Set IP address OK !!!
```



Info

When the LAN IP address is changed, the start IP address of DHCP server are still the same. To make the IP assignment of the DHCP server being consistent with this new IP address (they should be in the same network segment), the IP address of the PC must be fixed with the same LAN IP address (network segment) set by this command for accessing into the web user interface of the router. Later, modify the start addresses for the DHCP server.

Telnet Command: ip nmask

This command allows users to set/add a specified netmask for your router.

Syntax

ip nmask <IP netmask>

Syntax Description

Parameter	Description
<IP netmask>	It means the netmask of LAN IP. <IP netmask>=Enter the netmask.

Example

```
> ip nmask 255.255.0.0
% Set IP netmask OK !!!
```

Telnet Command: ip arp

ARP displays the matching condition for IP and MAC address.

Syntax

ip arp add <IP address> <MAC address> <LAN / WAN>

ip arp del <IP address> <LAN / WAN>

ip arp flush

ip arp status

ip arp accept <0/1/2/3/4/5/status>

ip arp setCacheLife <time>

In which, **arp add** allows users to add a new IP address into the ARP table; **arp del** allows users to remove an IP address; **arp flush** allows users to clear arp cache; **arp status** allows users to review current status for the arp table; **arp accept** allows to accept or reject the source /destination MAC address; **arp setCacheLife** allows users to configure the duration in which ARP caches can be stored on the system. If **ip arp setCacheLife** is set with "60", it means you have an ARP cache at 0 second. Sixty seconds later without any ARP messages received, the system will think such ARP cache is expired. The system will issue a few ARP request to see if this cache is still valid.

Syntax Description

Parameter	Description
<i>add</i> <IP address> <MAC address> <LAN / WAN>	It means to add one LAN IP address with subnet mask on selected interface. <IP address>: Enter an IP address. <MAC address>: Enter the MAC address of your router. <LAN / WAN>:It indicates the direction for the arp function.
<i>del</i> <IP address> <LAN / WAN>	It means to delete one LAN IP address on selected interface. <IP address>: Enter an IP address. <LAN / WAN>:It indicates the direction for the arp function
<i>accept</i> <0/1/2/3/4/5/status>	0: disable to accept illegal source mac address 1: enable to accept illegal source mac address 2: disable to accept illegal dest mac address 3: enable to accept illegal dest mac address 4: Decline VRRP mac into arp table 5: Accept VRRP mac into arp table status: display the setting status.
<i>setCacheLife</i> <time>	Available settings will be 10, 20, 30,...2550 seconds.

Example

```
> ip arp accept status
Accept illegal source mac arp: disable

Accept illegal dest mac arp: disable

Accept VRRP mac into arp table: disable
> ip arp status
[ARP Table]
  Index IP Address      MAC Address      Netbios Name
  1    192.168.1.113    00-05-5D-E4-D8-EE  A1000351
```

Telnet Command: ip dhcpc

This command is available for WAN DHCP.

Syntax

ip dhcpc *option*

```

ip dhcpc option -l
ip dhcpc option -d <idx>
ip dhcpc option -e <1 or 0> -w <wan unumber> -c <option number> -v <option value>
ip dhcpc option -e <1 or 0> -w <wan unumber> -c <option number> -x <option value>
ip dhcpc option -e <1 or 0> -w <wan unumber> -c <option number> -a <option value>
ip dhcpc option -u <idx unumber>
ip dhcpc release <wan number>
ip dhcpc renew <wan number>
ip dhcpc status

```

Syntax Description

Parameter	Description
<i>option</i>	It is an optional setting for DHCP server. -h: display usage -l: list all custom set DHCP options -d: delete custom dhcp client option by index number -e: enable/disable option feature, 1:enable, 0:disable -w: set WAN number (e.g., 1=WAN1) -c: set option number: 0-255 -v: set option value by string -x: set option value by raw byte (hex) -u: update by index number
<i>release</i>	It means to release current WAN IP address.
<i>renew</i>	It means to renew the WAN IP address and obtain another new one.
<i>status</i>	It displays current status of DHCP client.

Example

```

> ip dhcpc option -e 1 -w 1/2 -c 18 -v /path1
>

```

Telnet Command: ip ping

This command allows users to ping IP address of WAN1/WAN2/PVC3/PVC4/PVC5 for verifying if the WAN connection is OK or not.

Syntax

```
ip ping <IP address> <AUTO/WAN1/WAN2/PVC3/PVC4/PVC5> <Source IP address>
```

Syntax Description

Parameter	Description
<IP address>	It means the WAN IP address.
<AUTO/WAN1/PVC3/PVC4/PVC5>	It means the WAN port /PVC that the above IP address passes through.
<Source IP address>	Enter the IP address.

Example

```

> ip ping 192.168.1.1 AUTO

```

```
Pinging 192.168.1.1 with 64 bytes of Data through LAN

Receive reply from 192.168.1.1, time<lms
Receive reply from 192.168.1.1, time<lms
Receive reply from 192.168.1.1, time<lms
Receive reply from 192.168.1.1, time<lmsReceive reply from 192.168.1.1,
time<lms

Packets: Sent = 5, Received = 5, Lost = 0 (0% loss)
```

Telnet Command: ip tracert

This command allows users to trace the routes from the router to the host.

Syntax

```
ip tracert <IP address> <WAN1/WAN2/WAN3> <Udp/Icmp>
```

Syntax Description

Parameter	Description
< IP address>	It means the target IP address.
<WAN1/WAN2/WAN3>	It means the WAN port that the above IP address passes through.
<Udp/Icmp>	It means the UDP or ICMP.

Example

```
>ip tracert 22.128.2.62 WAN1
Traceroute to 22.128.2.62, 30 hops max
 1  172.16.3.7  10ms
 2  172.16.1.2  10ms
 3  Request Time out.
 4  168.95.90.66 50ms
 5  211.22.38.134 50ms
 6  220.128.2.62 50ms
Trace complete
```

Telnet Command: ip telnet

This command allows users to access specified device by telnet.

Syntax

```
ip telnet <IP address><Port>
```

Syntax Description

Parameter	Description
<IP address>	Enter the WAN or LAN IP address of the remote device.
<Port>	Type a port number (e.g., 23). Available settings: 0 -65535.

Example

```
> ip telnet 172.17.3.252 23
>
```

Telnet Command: ip rip

This command allows users to set the RIP (routing information protocol) of IP.

Syntax

ip rip <0/1/2>

Syntax Description

Parameter	Description
<0/1/2>	0 means disable; 1 means first subnet and 2 means second subnet.

Example

```
> ip rip 1
%% Set RIP LAN1.
```

Telnet Command: ip wanrip

This command allows users to set the RIP (routing information protocol) of WAN IP.

Syntax

```
ip wanrip <ifno> -e <0/1>
```

Syntax Description

Parameter	Description
<ifno>	It means the connection interface. 1: WAN1, 2:WAN2, 3: PVC3,4: PVC4,5: PVC5 Note: PVC3 -PVC5 are virtual WANs.
-e <0/1>	It means to disable or enable RIP setting for specified WAN interface. 1: Enable the function of setting RIP of WAN IP. 0: Disable the function.

Example

```
> ip wanrip ?
Valid ex:ip wanrip <ifno> -e <0/1>
<ifno> 1: WAN1, 2:WAN2
       3: PVC3,4: PVC4,5: PVC5
-e <0/1> 0: disable, 1: enable
Now status:
WAN[1] Rip Protocol disable
WAN[2] Rip Protocol disable
WAN[3] Rip Protocol disable
WAN[4] Rip Protocol disable
WAN[5] Rip Protocol disable
WAN[6] Rip Protocol enable
WAN[7] Rip Protocol enable
> ip wanrip 5 -e 1
> ip wanrip ?
Valid ex:ip wanrip <ifno> -e <0/1>
<ifno> 1: WAN1
       3: PVC3,4: PVC4,5: PVC5
-e <0/1> 0: disable, 1: enable
Now status:
WAN[1] Rip Protocol disable
WAN[2] Rip Protocol disable
WAN[3] Rip Protocol disable
WAN[4] Rip Protocol disable
WAN[5] Rip Protocol enable
WAN[6] Rip Protocol enable
WAN[7] Rip Protocol enable
```

Telnet Command: ip route

This command allows users to set static route.

Syntax

`ip route add <dst> <netmask> <gateway> <ifno> <rtype>`

`ip route del <dst> <netmask> <rtype>`

`ip route status`

`ip route cnc`

`ip route default off`

`ip route clean <1/0>`

Syntax Description

Parameter	Description
<code>add <dst> <netmask> <gateway> <ifno> <rtype></code>	It means to add an IP address as static route. <dst>: Enter the IP address of the destination. <netmask>: Enter the netmask of the specified IP address. <gateway>: Enter the gateway of the connected router. <ifno>: Speicfy the connection interface. 3=WAN1 4=WAN2 7=WAN5,8=WAN6,9=WAN7 <rtype>: Enter the type (default or static) of the route.
<code>del <dst> <netmask> <rtype></code>	It means to delete specified IP address. <dst>: Enter the IP address of the destination. <netmask>: Enter the netmask of the specified IP address. <rtype>: Enter the type (default or static) of the route.
<code>status</code>	It means current status of static route.
<code>cnc</code>	It means current IP range for CNC Network.
<code>default off</code>	It is available for NAT subnet only. Set the default route as off.
<code>clean <1/0></code>	Clean all of the route settings. 1: Enable the function. 0: Disable the function.

Example

```
> ip route add 172.16.2.0 255.255.255.0 172.16.2.4 3 static
> ip route status

Codes: C - connected, S - static, R - RIP, * - default, ~ - private
C~      192.168.1.0/    255.255.255.0 is directly connected, LAN1
S       172.16.2.0/    255.255.255.0 via 172.16.2.4, WAN1
```

Telnet Command: ip igmp_proxy

This command allows users to enable/disable igmp proxy server.

Syntax

`ip igmp_proxy set`

`ip igmp_proxy reset`

`ip igmp_proxy wan <1-4>`

`ip igmp_proxy query`

`ip igmp_proxy ppp <0/1>`

`ip igmp_proxy status`

`ip igmp_proxy version <v2/v3/auto/show>`

Syntax Description

Parameter	Description
<i>set</i>	It means to enable proxy server.
<i>reset</i>	It means to disable proxy server.
<i>wan <1-4></i>	It means to specify WAN interface for IGMP service.
<i>t_home</i>	It means to specify t_home proxy server for using.
<i>on/off/show/help</i>	It means to turn on/off/display or get more information of the T_home service.
<i>query <value></i>	It means to set IGMP general query interval. <value>: Enter a number. The default value is 125000 ms.
<i>ppp <0/1></i>	It means to enable or disable the function. 0: No need to set IGMP with PPP header. 1: Set IGMP with PPP header.
<i>status</i>	It means to display current status for proxy server.
<i>version <v2/v3/auto/show></i>	It means to change or display current version of IGMP proxy server. v2: version v2 v3: version v3 auto: version used will be detected automatically show: Disply current version used.

Example

```
> ip igmp_proxy query 130000
This command is for setting IGMP General Query Interval
The default value is 125000 ms
Current Setting is:130000 ms
> DrayTek> ip igmp_proxy version show
igmp version rule: auto
wan ver: v2
lan ver: v3
```

Telnet Command: ip igmp_snoop

This command allows users to enable or disable IGMP snoop function.

Syntax

```
ip igmp_snoop enable
ip igmp_snoop disable
ip igmp_snoop status
ip igmp_snoop txquery <on/off> <v2/v3>
ip igmp_snoop chkleave
ip igmp_snoop separate <on/off>
```

Syntax Description

Parameter	Description
<i>enable</i>	It means to enable igmp snoop function
<i>disable</i>	It means to disable igmp snoop function.
<i>status</i>	It means to display current igmp configuration.
<i>txquery <on/off> <v2/v3></i>	It means to send out IGMP QUERY to LAN periodically. On: enable Off: disable v2: version v2 v3: version v3
<i>chkleave <on/off></i>	It means to check the leave status. On: enable the IGMP snoop leave checking function. Off: it will drop LEAVE if still clients on the same group.
<i>separate <on/off></i>	It means to set IGMP packets being separated by NAT/Bridge. On: The packets will be separated. Off: The packets will not be separated by NAT/Bridge.

Example

```
> ip igmp_snoop enable
%% ip igmp snooping [enable|disable|status], IGMP Snooping is Enabled.
> ip igmp_snoop disable
%% ip igmp snooping [enable|disable|status], IGMP Snooping is Disabled.
> ip igmp_snoop separate ?
% ip igmp separate [on/off]
  igmp snoop seprate is ON now.
  igmp packets will be separated by NAT/Bridge.
```

Telnet Command: ip igmp_fl

This command allows users to enable or disable IGMP Fast Leave function.

Syntax

```
ip igmp_fl enable
ip igmp_fl disable
ip igmp_fl status
```

Syntax Description

Parameter	Description
<i>enable</i>	It means to enable IGMP Fast Leave function
<i>disable</i>	It means to disable IGMP Fast Leave function.
<i>status</i>	It means to display current IGMP Fast Leave configuration.

Example

```
> ip igmp_fl enable ?
  If you want to use IGMP fast leave , you "MUST" enable IGMP snooping.
> ip igmp_snoop enable
% ip igmp snooping [enable|disable|status], IGMP Snooping is Enabled.
> ip igmp_fl enable
%% ip igmp_fl [enable|disable|status], IGMP Fast Leave is Enabled.
```

Telnet Command: ip dmz

Specify MAC address of certain device as the DMZ host.

Syntax

```
ip dmz <mac>
```

Syntax Description

Parameter	Description
<mac>	It means the MAC address of the device that you want to specify

Example

```
>ip dmz ?
% ip dmz <mac>, now : 00-00-00-00-00-00
> ip dmz 11-22-33-44-55-66
> ip dmz ?
% ip dmz <mac>, now : 11-22-33-44-55-66
>
```

Telnet Command: ip dmzswitch

This command allows users to set DMZ mode.

```
ip dmzswitch off
ip dmzswitch private
```

ip dmzswitch *active_trueip*

Syntax Description

Parameter	Description
<i>off</i>	It means to turn off DMZ function.
<i>private</i>	It means to set DMZ with private IP.
<i>active_trueip</i>	It means to set the DMZ with active true IP.

Example

```
>ip dmzswitch off
>
```

Telnet Command: ip session

This command allows users to set maximum session limit number for the specified IP; set message for exceeding session limit and set how many seconds the IP session block works.

Syntax

ip session *on*

ip session *off*

ip session *default* <num>

ip session *defaultp2p* <num>

ip session *status*

ip session *show*

ip session *timer* <num>

ip session <block/unblock><IP>

ip session <add/del><IP1-IP2><num><p2pnum>

Syntax Description

Parameter	Description
<i>on</i>	It means to turn on session limit for each IP.
<i>off</i>	It means to turn off session limit for each IP.
<i>default</i> <num>	It means to set the default number of session num limit.
<i>defaultp2p</i> <num>	It means to set the default number of session num limit for p2p.
<i>status</i>	It means to display the current settings.
<i>show</i>	It means to display all session limit settings in the IP range.
<i>timer</i> <num>	It means to set when the IP session block works. The unit is second.
<block/unblock><IP>	It means to block/unblock the specified IP address. Block: The IP cannot access Internet through the router. Unblock: The specified IP can access Internet through the router.
<add/del><IP1-IP2><num><p2pnum>	It means to add / delete the session limits in an IP range. <IP1-IP2>: It means the range of IP address specified for this

	command. <num>: It means the number of the session limits, e.g., 100. <p2pnum>: It means the number of the session limits, e.g., 50 for P2P.
--	--

Example

```

> ip session default 100
> ip session add 192.168.1.5-192.168.1.100 100 50
> ip session on
> ip session status

IP range:
  192.168.1.5 - 192.168.1.100 : 100

Current ip session limit is turn on

Current default session number is 100

```

Telnet Command: ip bandwidth

This command allows users to set maximum bandwidth limit number for the specified IP.

Syntax

`ip bandwidth on`

`ip bandwidth off`

`ip bandwidth default <tx_rate><rx_rate>`

`ip bandwidth status`

`ip bandwidth show`

`ip bandwidth <add/del> <IP1-IP2><tx><rx><shared>`

Syntax Description

Parameter	Description
<i>on</i>	It means to turn on the IP bandwidth limit.
<i>off</i>	It means to turn off the IP bandwidth limit.
<i>default <tx_rate><rx_rate></i>	<tx_rate><rx_rate>: It means to set default tx and rx rate of bandwidth limit. The range is from 0 - 65535 Kpbs.
<i>status</i>	It means to display the current settings.
<i>show</i>	It means to display all the bandwidth limits settings within the IP range.
<i><add/del> <IP1-IP2><tx><rx><shared></i>	It means to add / delete the bandwidth within the IP range. <IP1-IP2>: It means the range of IP address specified for this command. <tx>: It means to set transmission rate for bandwidth limit. <rx>: It means to set receiving rate for bandwidth limit. <shared>: It means that the bandwidth will be shared for the IP range.

Example

```

> ip bandwidth default 200 800
> ip bandwidth add 192.168.1.50-192.168.1.100 10 60
> ip bandwidth status

IP range:
  192.168.1.50 - 192.168.1.100 : Tx:10K Rx:60K

Current ip Bandwidth limit is turn off
Auto adjustment is off
>

```

Telnet Command: ip bindmac

This command allows users to set IP-MAC binding for LAN host.

Syntax

`ip bindmac on`

`ip bindmac off`

`ip bindmac <strict_on/strict_off>`

`ip bindmac add <IP><MAC><Comment>`

`ip bindmac del <IP>/<all>`

`ip bindmac subnet <all/set LAN_Index/unset LAN_Index/clear/show>`

`ip bindmac show`

Syntax Description

Parameter	Description
<i>on</i>	It means to turn on IP bandmac policy. Even the IP is not in the policy table, it can still access into network.
<i>off</i>	It means to turn off all the bindmac policy.
<i><strict_on / strict_off></i>	It means that only those IP address in IP bindmac policy table can / can not access into network.
<i>add</i> <i><IP><MAC><Comment></i>	It means to add one ip bindmac. <IP>: It means to enter the IP address for binding with specified MAC address. <MAC>: It means to Enter the MAC address for binding with the IP address specified. <Comment>: It means to type words as a brief description.
<i>del <IP>/<all></i>	It means to delete one ip bindmac. <IP>: It means to enter the IP address for binding with specified MAC address. <all>: It means to delete all the IP bindmac settings.
<i>subnet <all/set LAN_Index/unset LAN_Index/clear/show></i>	It means to set LAN subnet to bind strict mode. <all>: It means to set all the LAN subnet to bind the strict mode. <set LAN_Index>: It means to specify the index number (1~4) of LAN subnet to enable the subnet setting. <unset LAN_Index>: It means to specify the index number (1~4) of LAN subnet to disable the subnet setting.

	<clear>: Remove the subnet settings. <show>: Display the subnet settings.
<i>show</i>	It means to display the IP address and MAC address of the pair of binded one.

Example

```

> ip bindmac add 192.168.1.46 00:50:7f:22:33:55 just for test
> ip bindmac show
ip bind mac function is turned OFF
ip bind mac function is STRICT OFF
Show all IP Bind MAC entries.
IP : 192.168.1.46 bind MAC : 00-50-7f-22-33-55 HOST ID : (null)
  Comment : just
> ip bindmac subnet set 2
Set LAN 1 is OK.
> ip bindmac subnet show
  LAN 2

>

```

Telnet Command: ip maxnatuser

This command is used to set the maximum number of NAT users.

Syntax

ip maxnatuser <user no>

Syntax Description

Parameter	Description
<user no>	A number specified here means the total NAT users that Vigor router supports. 0 - It means no limitation.

Example

```
> ip maxnatuser 100
% Max NAT user = 100
```

Telnet Command: ip spoofdef

This command is used to enable/disable the IP Spoofing Defense.

Syntax

ip spoofdef <WAN/LAN><0/1>

Syntax Description

Parameter	Description
<WAN/LAN>	It means to block IP packet from WAN/LAN with inconsistent source IP address.
<0/1>	0: Disable the function. 1: Enable the function.

Example

```
> ip spoofdef WAN 1
Setting saved:
>
```

Telnet Command: ip6 addr

This command allows users to set the IPv6 address for your router.

Syntax

ip6 addr -s <prefix> <prefix-length> <LAN1/LAN2/WAN1/WAN2/USB1/USB2/VPN1/..VPN32>

ip6 addr -d <prefix> <prefix-length> <LAN1/LAN2/WAN1/WAN2/USB1/USB2/VPN1/..VPN32>

ip6 addr -a <LAN1/LAN2/WAN1/WAN2/USB1/USB2/VPN1/..VPN32> -u

ip6 addr -v <LAN1/LAN2/WAN1/WAN2/USB1/USB2>

ip6 addr -t <old-prefix><old-prefix-length><new-prefix> <new-prefix-length>
<LAN1/LAN2/WAN1/WAN2/USB1/USB2>

ip6 addr -o <1/2>

ip6 addr -o 3 <prefix> <prefix-length> <WAN1/WAN2/USB1/USB2>

ip6 addr -l <prefix> <prefix-length> <LAN1/LAN2>
ip6 addr <-p/-b> <prefix> <prefix-length> <WAN1/WAN2/USB1/USB2>
ip6 addr -x <LAN1/LAN2>
ip6 addr -c <LAN1/LAN2>
ip6 addr -e <type> <LAN1/LAN2>

Syntax Description

Parameter	Description
-s <prefix> <prefix-length> <LAN1/LAN2/WAN1/WAN2/USB1/USB2/VPN1/..VPN32>	It means to add a static ipv6 address. <prefix>: It means to enter the prefix number of IPv6 address. <prefix-length>: It means to enter a fixed value as the length of the prefix. <LAN1/LAN2/WAN1/WAN2/USB1/USB2/VPN1/..VPN32>: It means to specify LAN/WAN/USB/VPN interface for such address.
-d <prefix> <prefix-length> <LAN1/LAN2/WAN1/WAN2/USB1/USB2/VPN1/..VPN32>	It means to delete an ipv6 address. <prefix>: It means to enter the prefix number of IPv6 address. <prefix-length>: It means to enter a fixed value as the length of the prefix. <LAN1/LAN2/WAN1/WAN2/USB1/USB2/VPN1/..VPN32>: It means to specify LAN/WAN/USB/VPN interface for such address.
-a <LAN1/LAN2/WAN1/WAN2/USB1/USB2/VPN1/..VPN32> -u	It means to show current address(es) status. <LAN1/LAN2/WAN1/WAN2/USB1/USB2/VPN1/..VPN32>: It means to specify LAN/WAN/USB/VPN interface. <-u>: It means to show unicast address only.
-v <LAN1/LAN2/WAN1/WAN2/USB1/USB2>	It means to show prefix list status.
-t <old-prefix><old-prefix-length><new-prefix> <new-prefix-length> <LAN1/LAN2/WAN1/WAN2/USB1/USB2>	It means to update WAN static IPv6 address table. <old-prefix>: It means to enter the prefix number of IPv6 address. <old prefix-length>: It means to enter a fixed value as the length of the prefix. <new-prefix>: It means to enter the prefix number of IPv6 address. <new-prefix-length>: It means to enter a fixed value as the length of the prefix. <LAN1/LAN2/WAN1/WAN2/USB1/USB2 >: It means to specify LAN/WAN/USB interface for such address.
-o <1/2>	<1>: It means to show old prefix list. <2>: It means to send old prefix option by RA.
-o <3> <prefix> <prefix-length> <WAN1/WAN2/USB1/USB2>	<3>: It means to set old prefix. <prefix>: It means to enter the prefix number of IPv6 address. <prefix-length>: It means to enter a fixed value as the length of the prefix. <WAN1/WAN2/USB1/USB2 >: It means to specify a WAN/USB interface for such address.

<code>-l <prefix> <prefix-length> <LAN1/LAN2></code>	It means to add a ULA. <prefix>: It means to enter the prefix number of IPv6 address. <prefix-length>: It means to enter a fixed value as the length of the prefix. <LAN1/LAN2 >: It means to specify a LAN interface for such address.
<code>-p/-b <prefix> <prefix-length> <WAN1/WAN2/USB1/USB2></code>	It means to add/delete an prefix to/from prefix list. p: Add a prefix to a prefix list. b: Delete a prefix from a prefix list. <prefix>: It means to enter the prefix number of IPv6 address. <prefix-length>: It means to enter a fixed value as the length of the prefix. <WAN1/WAN2/USB1/USB2 >: It means to specify a WAN/USB interface for such address.
<code>-x <LAN1/LAN2></code>	It means to generate a ULA automatically. <LAN1/LAN2 >: It means to specify a LAN interface.
<code>-c <LAN1/LAN2></code>	It means to delete a ULA . <LAN1/LAN2 >: It means to specify a LAN interface.
<code>-e <type> <LAN1/LAN2></code>	It means to set ULA type. <type>: 0, disable; 1, static; 2, auto <LAN1/LAN2 >: It means to specify a LAN interface.

Example

```
> ip6 addr -a
LAN
Unicast Address:
FE80::250:7FFF:FE00:0/64 (Link)
Multicast Address:
FF02::2
FF02::1:FF00:0
FF02::1
> ip6 addr -o 3 2001:: 64 WAN2
% set WAN2 2001::/64 ok
```

Telnet Command: ip6 dhcp req_opt

This command is used to configure option-request settings for DHCPv6 client.

Syntax

```
ip6 dhcp req_opt <LAN1/LAN2/WAN1/WAN2/USB1/USB2> [-<command> <parameter>] ... ]
```

Syntax Description

Parameter	Description
<code>req_opt</code>	It means option-request.
<code><LAN1/LAN2/WAN1/WAN2/USB1/USB2></code>	It means to specify LAN or WAN or USB interface for such address.

<i>[<command> <parameter>/...]</i>	The available commands with parameters are listed below. <i>[...]</i> means that you can Enter several commands in one line.
<i>-a</i>	It means to show current DHCPv6 status.
<i>-s</i>	It means to ask the SIP.
<i>-S</i>	It means to ask the SIP name.
<i>-d</i>	It means to ask the DNS setting.
<i>-D</i>	It means to ask the DNS name.
<i>-n</i>	It means to ask NTP.
<i>-i</i>	It means to ask NIS.
<i>-I</i>	It means to ask NIS name.
<i>-p</i>	It means to ask NISP.
<i>-P</i>	It means to ask NISP name.
<i>-b</i>	It means to ask BCMCS.
<i>-B</i>	It means to ask BCMCS name.
<i>-r</i>	It means to ask refresh time.
<i>Parameter</i>	1: the parameter related to the request will be displayed. 0: the parameter related to the request will not be displayed.

Example

```
> ip6 dhcp req_opt WAN2 -S 1
> ip6 dhcp req_opt WAN2 -r 1
> ip6 dhcp req_opt WAN2 -a
% Interface WAN2 is set to request following DHCPv6 options:
%   sip name
>
```

Telnet Command: ip6 dhcp client

This command allows you to use DHCPv6 protocol to obtain IPv6 address from server.

Syntax

`ip6 dhcp client <WAN1/WAN2/USB1/USB2><-<command> <parameter>/ ... >`

Syntax Description

Parameter	Description
<i>client</i>	It means the dhcp client settings.
<i><<command> <parameter>/...></i>	The available commands with parameters are listed below. <i>[...]</i> means that you can Enter several commands in one line.
<i>-r</i>	It means to send a RELEASE message.
<i>-a</i>	It means to show current DHCPv6 status.
<i>-p <IAID></i>	It means to request identity association ID for Prefix Delegation.
<i>-n <IAID></i>	It means to request identity association ID for

	Non-temporary Address.
<i>-t <time></i>	It means to set solicit interval. <time>: 0 ~ 7 seconds (default value is 0).
<i>-c <parameter></i>	It means to send rapid commit to server. 1: Enable 0: Disable
<i>-i <parameter></i>	It means to send information request to server. 1: Enable 0: Disable
<i>-e <parameter></i>	It means to enable or disable the DHCPv6 client. 1: Enable 0: Disable
<i>-m <parameter></i>	It means to enable/disable server DUID set by Link layer and time. 1: Enable 0: Disable
<i>-d</i>	It means to display the client DUID.
<i>-A <parameter></i>	It means to set authentication protocol. 0: Undefined 2: delayed protocol
<i>-R <parameter></i>	It means to set realm value (max: 31 characters) in delayed protocol. <parameter>: Enter a string.
<i>-S <parameter></i>	It means to set shared secret (max: 31 characters) in delayed protocol. <parameter>: Enter a string.
<i>-K <parameter></i>	It means to set key ID (1~65535) in delayed protocol. <parameter>: Enter a number.

Example

```

> ip6 dhcp client WAN2 -p 2008::1
> ip6 dhcp client WAN2 -a
Interface WAN2 has following DHCPv6 client settings:
    DHCPv6 client enabled
    request IA_PD whose IAID equals to 2008
> ip6 dhcp client WAN2 -n 1023456
> ip6 dhcp client WAN2 -a
Interface WAN2 has following DHCPv6 client settings:
    DHCPv6 client enabled
    request IA_NA whose IAID equals to 2008
> system reboot

```

Telnet Command : ip6 dhcp server

This command allows you to configure DHCPv6 server.

Syntax

`ip6 dhcp server -<<command> <parameter>/ ...>`

Syntax Description

Parameter	Description
<i>server</i>	It means the dhcp server settings.
<<command>> <parameter>/...>	The available commands with parameters are listed below. <...> means that you can Enter several commands in one line.
<i>-a</i>	It means to show current DHCPv6 status.
<i>-b</i>	It means to show current DHCPv6 IP Assignment Table.
<i>-n <name></i>	It means to set a profile name. <name>: Enter a string as profile name.
<i>-c <parameter></i>	It means to send rapid commit to server. <parameter>: Enter 1 or 0. 1: Enable 0: Disable
<i>-e <parameter></i>	It means to enable or disable the DHCPv6 server. <parameter>: Enter 1 or 0. 1: Enable 0: Disable
<i>-t <time></i>	It means to set prefer lifetime. <time>: Enter a value.
<i>-y <time></i>	It means to set valid lifetime. <time>: Enter a value.
<i>-u <time></i>	It means to set T1 time. <time>: Enter a value.
<i>-o <time></i>	It means to set T2 time. <time>: Enter a value.
<i>-i <pool_min_addr></i>	It means to set the start IPv6 address of the address pool. <pool_min_addr>: Enter an IPv6 address.
<i>-x <pool_max_addr></i>	It means to set the end IPv6 address of the address pool. <pool_max_addr>: Enter an IPv6 address.
<i>-R</i>	It means to send reconfigure packet to a client.
<i>-r <1/0></i>	It means to enable (1) or disable (0) auto_range.
<i>-N <1/0></i>	It means to enable (1) or disable (0) random address allocation.
<i>-d <addr></i>	It means to set the first DNS IPv6 address. <addr> : Enter an IPv6 address.
<i>-D <addr></i>	It means to set the second DNS IPv6 address. <addr> : Enter an IPv6 address.
<i>-m <1/0></i>	It means to enable(1) or disable (0) the server DUID set by Link Layer and Time.
<i>-q <name></i>	It means to set DNS domain search list. <name>: Enter a name.
<i>-z<1/0></i>	It means enable (1) or disable (0) the DHCP PD.
<i>pdadd</i>	It means to add PD node.

<code><suffix><prefix_len><client linklocal><client DUID></code>	
<code>pddel <PD index></code>	It means to delete PD node. <PD index>: Enter a number.
<code>-A <parameter></code>	It means to set authentication protocol. <parameter>: Enter 0, 2 or 3. 0: Undefine 2: delayed protocol 3: Reconfigure key
<code>-M <parameter></code>	It means to set realm value (max: 31 characters) in delayed protocol. <parameter>: Enter a string.
<code>-S <parameter></code>	It means to set shared secret (max: 31 characters) in delayed protocol. <parameter>: Enter a string.
<code>-K <parameter></code>	It means to set key ID (1-65535) in delayed protocol. <parameter>: Enter a number.

Example

```
> ip6 dhcp server -d FF02::1
> ip6 dhcp server -i ff02::1
> ip6 dhcp server -x ff02::3
> ip6 dhcp server -a
% Interface LAN has following DHCPv6 server settings:
%   DHCPv6 server disabled
%   maximum address of the pool: FF02::3
%   minimum address of the pool: FF02::1
%   1st DNS IPv6 Addr: FF02::1
```

Telnet Command: ip6 internet

This command allows you to configure settings for accessing Internet.

Syntax

`ip6 internet <-<command> <parameter> / ... >`

Syntax Description

Parameter	Description
<code><command></code> <code><parameter>/...</code>	The available commands with parameters are listed below. <...> means that you can Enter several commands in one line.
<code>-W <n></code>	W means to set WAN interface and n means different selections. Default is WAN1. n=1: WAN1 n=2: WAN2 n=3: WAN3 . . n=X: WANx
<code>-M <n></code>	M means to set Internet Access Mode (Mandatory) and n means different modes (represented by 0 - 5) n=0: Offline, n=1: PPP, n=2: TSPC,

	n=3: AICCU, n=4: DHCPv6, n=5: Static n=6: 6in4-Static n=7: 6rd
-m n	It means to set IPv6 MTU. n = any value (0 means "unspecified").
<i>6rd</i>	
-C <n>	It means to set 6rd connection mode. n=0: Auto n=1: Static
-s <server>	It means to set 6rd IPv4 Border Relay. <server>: Enter a string.
-m <n>	It means to set 6rd IPv4 address mask length. <n>: Enter a number.
-p <prefix>	It means to set IPv6 prefix for 6rd connection. <prefix>: Enter a prefix number of IPv6 address.
-l <n>	It means to set the prefix length for 6rd connection. <n>: It means to enter a fixed value as the length of the prefix.
<i>6in4</i>	
-s <server>	It means to set 6in4 remote endpoint IPv4 address.
-l <IPv6 Addr>	It means to set the IPv6 address for 6in4 connection.
-P <n>	It means to set IPv6 WAN prefix length for 6in4 connection.
-p <prefix>	It means to set 6in4 LAN Routed Prefix.
-l <n>	It means to set 6in4 LAN Routed Prefix length.
-T <n>	It means to set 6in4 Tunnel TTL.
<i>TSPC/AICCU</i>	
-u <username>	It means to set username (max. 63 characters). <username>: Enter a string.
-P <password>	It means to set Password (max. 63 characters). <password>: Enter a password.
-s <server>	It means to set Tunnel Server IP. <server>: Enter an IPv4 Address or URL (max. 63 characters)
<i>AICCU</i>	
-p <prefix>	It means to set Subnet Prefix (AICCU). <prefix>: Enter a prefix number of IPv6 address.
-l <n>	It means to set Subnet Prefix length (AICCU). <n>: Enter a number.
-o <1/0>	It means to set AICCU always on. 1: on 0: off
-f	It means to set AICCU tunnel ID.
<i>Static</i>	
-w <addr>	It means to set Default Gateway. <addr>: Enter an IPv6 address.
<i>Others</i>	
-d <server>	It means to set 1st DNS Server IP. <server>: Enter an IPv6 address.
-D <server>	It means to set 2nd DNS Server IP. <server>: Enter an IPv6 address.
-t <dhcp/ra/none>	It means to set ipv6 PPP WAN test mode for DHCP or RA. <dhcp/ra/none> : Enter dhcp, ra or none.
-V	It means to view IPv6 Internet Access Profile.
-k	It means to dial the Tunnel on the WAN.
-j	It means to drop the Tunnel on the WAN.
-r n	It means to set Prefix State Machine RA timeout.
-c n	It means to set Prefix State Machine DHCPv6 Client timeout.
-q <0/1/2>	It means to set WAN detection mode.

	0:NS Detect 1:Ping Detect 2:Always On
-z <value>	It means to set Ping Detect TTL (0-255). <value>: Enter 0-255.
-x <hostname/ IPv6 addr>	It means to set Ping Detect Host (hostname or IPv6 address). <hostname/ipv6 addr> : Enter a hostname or an IPv6 address.
-i <value>	It means to set ipv6 connection interval. <value>: Enter a number (1500-60000 (unit:10ms)).
-b <0/1>	It means to enable DNSv6 based on DHCPv6. 1 = on 0 = off
-R <0/1>	It means to Enable RIPng. 1 = on 0 = off

Example

```
> ip6 internet -W 2 -M 2 -u 88886666 -p draytek123456 -s amsterdam.freenet6.net
This setting will take effect after rebooting.
Please use "sys reboot" command to reboot the router.
> system reboot
```

Telnet Command: ip6 neigh

This command allows you to set a IPv6 neighbour table.

Syntax

```
ip6 neigh -s <inet6_addr> <eth_addr> <LAN1/LAN2/WAN1/WAN2/USB1/USB2>
```

```
ip6 neigh -d <inet6_addr> <LAN1/LAN2/WAN1/WAN2/USB1/USB2>
```

```
ip6 neigh -a <inet6_addr> <-N LAN1/LAN2/WAN1/WAN2/USB1/USB2>
```

Syntax Description

Parameter	Description
<code>-s <inet6_addr> <eth_addr> <LAN1/LAN2/WAN1/WAN2/USB1/USB2></code>	It means to add a neighbour. <inet6_addr>: Enter an IPv6 address. <eth_addr>: Enter a submask address. <LAN1/LAN2/WAN1/WAN2/USB1/USB2>: Specify an interface for the neighbor.
<code>-d <inet6_addr> <LAN1/LAN2/WAN1/WAN2/USB1/USB2></code>	It means to delete a neighbour. <inet6_addr>: Enter an IPv6 address. <LAN1/LAN2/WAN1/WAN2/USB1/USB2>: Specify an interface for the neighbor.
<code>-a <inet6_addr> -N <LAN1/LAN2/WAN1/WAN2/USB1/USB2></code>	It means to show neighbour status. <inet6_addr>: Enter an IPv6 address. <LAN1/LAN2/WAN1/WAN2/USB1/USB2>: Specify an interface for the neighbor.

Example

```
> ip6 neigh -s 2001:2222:3333::1111 00:50:7F:11:ac:22:WAN1
    Neighbour 2001:2222:3333::1111 successfully added!
> ip6 neigh -a

I/F  ADDR                               MAC                               STATE
-----
LAN1  2001:2222:3333::1111              IN_TIMER
LAN4  ::                                  NONE
LAN3  ::                                  NONE
LAN1  ::                                  NONE
LAN2  ::                                  NONE
DMZ   ::                                  NONE
>
```

Telnet Command: ip6 pneigh

This command allows you to add a proxy neighbour.

Syntax

```
ip6 pneigh -s <inet6_addr> <LAN1/LAN2/WAN1/WAN2/USB1/USB2>
```

```
ip6 pneigh -d <inet6_addr><LAN1/LAN2/WAN1/WAN2/USB1/USB2>
```

```
ip6 pneigh -a <inet6_addr> <-N LAN1/LAN2/WAN1/WAN2/USB1/USB2>
```

Syntax Description

Parameter	Description
-s <inet6_addr> <eth_addr> <LAN1/LAN2/WAN1/WAN2/USB1/USB2>	It means to add a proxy neighbour. <inet6_addr>: Enter an IPv6 address. <eth_addr>: Enter a submask address. <LAN1/LAN2/WAN1/WAN2/USB1/USB2>: Specify an interface for the proxy neighbor.
-d <inet6_addr> <LAN1/LAN2/WAN1/WAN2/USB1/USB2>	It means to delete a proxy neighbour. <inet6_addr>: Enter an IPv6 address. <LAN1/LAN2/WAN1/WAN2/USB1/USB2>: Specify an interface for the proxy neighbor.
-a <inet6_addr> -N <LAN1/LAN2/WAN1/WAN2/USB1/USB2>	It means to show proxy neighbour status. <inet6_addr>: Enter an IPv6 address. <LAN1/LAN2/WAN1/WAN2/USB1/USB2>: Specify an interface for the proxy neighbor.

Example

```
> ip6 neigh -s FE80::250:7FFF:FE12:300 LAN1
%      Neighbour FE80::250:7FFF:FE12:300 successfully added!
```

Telnet Command: ip6 route

This command allows you to set route for IPv6 connection.

Syntax

```
ip6 route -s <prefix> <prefix-length> <gateway> <LAN1/LAN2/WAN1/WAN2/USB1/USB2/VPN1-VPN32> <-D>
```

```
ip6 route -d <prefix> <prefix-length>
```

```
ip6 route -a <LAN1/LAN2/WAN1/WAN2/ USB1/USB2/VPN1-VPN32>
```

```
ip6 route -l
```

Syntax Description

Parameter	Description
-s <prefix> <prefix-length> <gateway> <LAN1/LAN2/WAN1/WAN2/USB1/USB2/VPN1-VPN32> <-D>	It means to add a route. <prefix>: It means to enter the prefix number of IPv6 address. <prefix length>: It means to enter a fixed value as the length of the prefix. <gateway>: It means to enter the gateway of the router. <LAN1/LAN2/WAN1/WAN2/ USB1/USB2/VPN1-VPN32>: It means to specify LAN or WAN or VPN interface for such address. <-D>: It means that such route will be treated as the

	default route.
-d <prefix> <prefix-length>	It means to delete a route. <prefix>: It means to enter the prefix number of IPv6 address. <prefix length>: It means to enter a fixed value as the length of the prefix.
-a <LAN1/LAN2/WAN1/WAN2/USB1/USB2/VPN1~VPN32>	It means to show the route status. <LAN1/LAN2/WAN1/WAN2/ USB1/USB2/VPN1~VPN32>: It means to specify LAN or WAN or VPN interface for such address.
-/	It means to clear the routing table.

Example

```
> ip6 route -s FE80::250:7FFF:FE12:500 16 FE80::250:7FFF:FE12:100 LAN1
%      Route FE80::250:7FFF:FE12:500/16 successfully added!
> ip6 route -a LAN1

PREFIX/PREFIX-LEN                                I/F METRIC FLAG NEXT-HOP
-----
::0.0.0.1/128                                    LAN1    0 U  ::
FE80::/128                                       LAN1    0 U  ::
FE80::21D:AAFF:FE00:0/128                       LAN1    0 U  ::
FE80::/64                                         LAN1   256 U  ::
FE80::/16                                         LAN1  1024 UGS
                                                    FE80::250:7FFF:FE12:100
FF00::/8                                          LAN1   256 U  ::
```

Telnet Command: ip6 ping

This command allows you to pin an IPv6 address or a host.

Syntax

ip6 ping <IPv6 address/Host> <LAN1/LAN2/WAN1/WAN2/USB1/USB2> <send count>
<data_size>

Syntax Description

Parameter	Description
<IPv6 address/Host>	It means to specify the IPv6 address or host for ping.
<LAN1/LAN2/WAN1/WAN2/USB1/USB2>	It means to specify LAN or WAN interface for such address.
<send count>	It means to set the request number of ping. Default number is 5.
<data_size>	It means to set the data size (1 to 1452). <data_size>: Enter a value.

Example

```
> ip6 ping 2001:4860:4860::8888 WAN1

Pinging 2001:4860:4860::8888 with 64 bytes of Data:

Receive reply from 2001:4860:4860::8888, time=330ms
Receive reply from 2001:4860:4860::8888, time=330ms
Receive reply from 2001:4860:4860::8888, time=330ms
```

```

Receive reply from 2001:4860:4860::8888, time=330ms
Receive reply from 2001:4860:4860::8888, time=330ms

Packets: Sent = 5, Received = 5, Lost = 0 <% loss>
>

```

Telnet Command: ip6 tracert

This command allows you to trace the routes from the router to the host.

Syntax

`ip6 tracert <IPv6 address/Host><LAN1/LAN2/WAN1/WAN2/USB1/USB2>`

Syntax Description

Parameter	Description
<code><IPv6 address/Host></code>	It means to specify the IPv6 address or host for ping.
<code><LAN1/LAN2/WAN1/WAN2/USB1/USB2></code>	It means to specify LAN or WAN interface for such address.

Example

```

> ip6 tracert 2001:4860:4860::8888
traceroute to 2001:4860:4860::8888, 30 hops max through protocol ICMP
 1 2001:5C0:1400:B::10B8      340 ms
 2 2001:4DE0:1000:A22::1     330 ms
 3 2001:4DE0:A::1           330 ms
 4 2001:4DE0:1000:34::1     340 ms
 5 2001:7F8:1: :A501:5169:1 330 ms
 6 2001:4860::1:0:4B3       350 ms
 7 2001:4860::8:0:2DAF      330 ms
 8 2001:4860::2:0:66E      340 ms
 9 Request timed out.      *
10 2001:4860:4860::8888    350 ms
Trace complete.
>

```

Telnet Command: ip6 tpspc

This command allows you to display TSPC status.

Syntax

`ip6 tpspc <ifno>`

Syntax Description

Parameter	Description
<code><ifno></code>	It means the connection interface. Ifno=1 (means WAN1) Ifno=2 (means WAN2)

Example

```

> ip6 tpspc 1
Local Endpoint v4 Address : 111.243.177.223
Local Endpoint v6 Address : 2001:05c0:1400:000b:0000:0000:0000:10b9

```

```

Router DNS name : 88866666.broker.freenet6.net
Remote Endpoint v4 Address :81.171.72.11
Remote Endpoint v6 Address : 2001:05c0:1400:000b:0000:0000:0000:10b8
Tspc Prefixlen : 56
Tunnel Broker: Amsterdam.freenet.net

Status: Connected

>

```

Telnet Command: ip6 radvd

This command allows you to enable or disable RADVD server.

Syntax

ip6 radvd <LAN1/LAN2> <-<command> <parameter>/ ... >

Syntax Description

Parameter	Description
<<command> <parameter>/...>	The available commands with parameters are listed below. <...> means that you can Enter several commands in one line.
-s <0/1>	It means to enable or disable the default lifetime of the RADVD server. 1: Enable the RADVD server. 0: Disable the RADVD server.
-D <0/1/2>	It means to set RDNSS Disable/Enable/Deploy (0/1/2) when WAN is up.
-d <lifetime>	It means to set RA default lifetime.
-i <lifetime>	It means to set RA min interval time(sec).
-l <lifetime>	It means to set RA MAX interval time(sec).
-h <hoplimit>	It means to set RA hop limit.
-m <mtu/auto>	It means to set RA MTU, 1280-1500. mtu: auto - auto select MTU from WAN,
-e <time>	It means to set reachable time.
-a <time/infinity>	It means to set retransmit timer /infinity.
-p <0/1/2>	It means to set radvd default preference Low/Medium/High. 0-low 1-medium 2-high
-v	It means to view radvd configuration.
-V	It means to view setting in RA.
-L <time/infinity>	It means to set prefix valid lifetime.
-P <time/infinity>	It means to set prefix preferred lifetime.
-r <num>	It means to to set RA test for item. <num>: 0, 121, 124 0: default, 121: logo 121, 124: logo 124..
-R	It means to reload Config and send RA for subnets.
-u	It means to view MTU on all interfaces.

Example

```

> ip6 radvd LAN1 -V
% [LAN1] setting !
% Default Lifetime : 0 seconds
% min interval time : 200 seconds
% MAX interval time : 600 seconds

```

% Hop limit	: 64
% MTU	: 0
% Reachable time	: 0
% Retransmit time	: 0
% Preference	: Medium

Telnet Command: ip6 mngt

This command allows you to manage the settings for access list.

Syntax

`ip6 mngt list`

`ip6 mngt list add <Index> <prefix><prefix-length>`

`ip6 mngt list remove <Index>`

`ip6 mngt list flush`

`ip6 mngt status`

`ip6 mngt <internet/ http/telnet/ping/https/ssh/enforce_https> <on/off>`

Syntax Description

Parameter	Description
<code>list</code>	It means to show the setting information of the access list.
<code>status</code>	It means to show the status of IPv6 management.
<code>add <Index> <prefix><prefix-length></code>	It means to add an IPv6 address which can be used to execute management through Internet. <index>: It means the number (1, 2 and 3) allowed to be configured for IPv6 management. <prefix>: It means to enter the prefix number of IPv6 address. <prefix-length>: It means to enter a fixed value as the length of the prefix.
<code>remove <Index></code>	It means to remove (delete) the specified index number with IPv6 settings. <index>: It means the number (1, 2 and 3) allowed to be configured for IPv6 management.
<code>flush</code>	It means to clear the IPv6 access table.
<code>status</code>	It means to display current status of IPv6 access list.
<code><internet/ http/telnet/ping/https/s sh/enforce_https></code>	These protocols are used for accessing Internet.
<code><on/off></code>	It means to enable (on) or disable (off) the Internet accessing through http/telnet/ping.

Example

```
> ip6 mngt list add 1 2607:f0d0:1002:51::4 64
> ip6 mngt status
% IPv6 Remote Management :
internet access : off, telnet : off, http : off, https : off, ssh :
off, ping : off, enforce_https : off
> ip6 mngt list
% IPv6 Access List :
Index IPv6 Prefix Prefix Length
=====
1      2607:F0D0:1002:51::4 64
```

Telnet Command: ip6 online

This command allows you to check the online status of IPv6 WAN/USB.

Syntax

`ip6 online <WAN1/WAN2/USB1/USB2>`

Syntax Description

Parameter	Description
<code><WAN1/WAN2/USB1/USB2></code>	It means the connection interface.

Example

```
> ip6 online WAN1
% WAN1 online status :
% IPv6 WAN1 Disabled
% Default Gateway : ::
% Interface : DOWN
% UpTime : 0:00:00
% IPv6 DNS Server: :: Static
% IPv6 DNS Server: :: Static
% IPv6 DNS Server: :: Static
% Tx packets = 0, Tx bytes = 0, Rx packets = 0, Rx bytes = 0
% MTU Onlink: 1280 , Config MTU : 0
```

Telnet Command: ip6 aiccu

This command allows you to set IPv6 settings for WAN interface with connection type of AICCU.

Syntax

`ip6 aiccu -i <ifno> -r`

`ip6 aiccu -i <ifno> -s`

Syntax Description

Parameter	Description
<code><ifno></code>	It means the connection interface. 1=WAN1 2=WAN2
<code>-r</code>	It means to remove (delete) the specified index number with IPv6 settings.
<code>-s</code>	It means to display the AICCU status.

Example

```
> ip6 aiccu -i 1 -s
Status: Idle
```

Telnet Command: ip6 ntp

This command allows you to set IPv6 settings for NTP (Network Time Protocols) server.

Syntax

`ip6 ntp -h`

`ip6 ntp -v`

`ip6 ntp -p <0/1>`

Syntax Description

Parameter	Description
-h	It is used to display the usage of such command.
-v	It is used to show the NTP state.
-p <0/1>	It is used to specify NTP server for IPv6. 0 - Auto 1 - First Query IPv6 NTP Server.

Example

```
> ip6 ntp -p 1
% Set NTP Priority: IPv6 First
```

Telnet Command: ip6 lan

This command allows you to set IPv6 settings for LAN interface.

Syntax

ip6 lan -l n <-<l:w:d:D:m:o:s> <parameter> / ... >

Syntax Description

Parameter	Description
-h	It is used to display the usage of such command.
-l <n>	It means to selete LAN interface to be set. n= 1: LAN1 n= 2: LAN2, ... x: LANx. Default is LAN1
-w <n>	It means to selete WAN interface to be primary interface. n= 0: None, n=1: WAN1 , n=2: WAN2, ... x: WANx.
-d <server>	It means to set 1st DNS Server IP. <server>: Enter the IPv6 Address.
-D <server>	It means to set 2nd DNS Server IP. <server>: Enter the IPv6 Address.
-m <n>	It means to set ipv6 LAN management. n=0:OFF n=1:SLAAC. Default is SLAAC n=2:DHCPv6
-o <n>	It means to enable Other option(O-bit) flag. (O-bit is redundant when management is DHCPv6) n=0: Disable n=1: Enable.
-e <n>	It means to add an extension WAN. n: 1: WAN1, 2: WAN2, ... x: WANx.
-E <n>	It means to delete an extension WAN. n: 1: WAN1 ,2: WAN2, ... x: WANx.
-b <map>	It means to set bit map(decimal) for extension WAN. <map>: 0: WAN1; 1: WAN2, ... n: WAN(n+1).
-f <n>	It means to disable IPv6. n=1: Disable IPv6, n=0: Enable IPv6.
-R <n>	It means to enable /disable RIPng. n=1: Enable RIPng, n=0: Disable RIPng.
-s <n>	It means to show IPv6 LAN setting. n=0:show all. Default is show all.

n=1: LAN1 n=2: LAN2, n=3: DMZ.

Example

```
> ip6 lan -l 1 -w 1 -d 2001:4860:4860::8888 -o 1 -f 0 -s 2
% Set primary WAN1!

% Set 1st DNS server 2001:4860:4860::8888

% Set Other Option Enable!

% [LAN1] support ipv6!

This setting will take effect after rebooting.
Please use "sys reboot" command to reboot the router.

% [LAN2] setting:
% Primary WAN : WAN1
% Management : SLAAC
% Other Option : Disable
% WAN Exten : None
% Subnet ID : 2
% Static IP(0) : ::/0
% [ifno: 0, enable: 0]
% Static IP(1) : ::/0
% [ifno: 0, enable: 0]
% Static IP(2) : ::/0
% [ifno: 0, enable: 0]
% Static IP(3) : ::/0
% [ifno: 0, enable: 0]
% DNS1 : 2001:4860:4860::8888
% DNS2 : 2001:4860:4860::8844
% ULA Type : OFF
% RIPng : Enable
```

Telnet Command: ip6 session

This command allows you to set sessions limit for IPv6 address.

Syntax

`ip6 session on`

`ip6 session off`

`ip6 session default <num>`

`ip6 session status`

`ip6 session show`

`ip6 session add <P1-IP2><num>`

`ip6 session del <P1>/<all>`

Syntax Description

Parameter	Description
<code>on</code>	It means to turn on session limit for each IP.
<code>off</code>	It means to turn off session limit for each IP.
<code>default <num></code>	It means to set the default number of session num limit. <num>: Enter a number.
<code>status</code>	It means to display the current settings.
<code>show</code>	It means to display all IP range session limit settings.
<code>add <P1-IP2><num></code>	<add/del>: It means to add the session limit for an IPv6

	range. <IP1-IP2> : Specify a range for IPv6 addresses. <num>: Enter a number.
<i>del<IP1> /all</i>	: It means to delete the session limit for an IPv6 range. <IP1> : Specify the first IPv6 address within the IPv6 range. all: Delete all the session limits.

Example

```

> ip6 session on
> ip6 session add 2100:ABCD::2-2100:ABCD::10 100
> ip6 session status

IPv6 range:
  2100:ABCD::2 - 2100:ABCD::10 : 100

Current ip6 session limit is turn on

Current default session number is 100

```

Telnet Command: ip6 bandwidth

This command allows you to set IPv6 settings

Syntax

ip6 bandwidth on

ip6 bandwidth off

ip6 bandwidth default <tx_rate> <rx_rate>

ip6 bandwidth status

ip6 bandwidth show

ip6 bandwidth add <IP1-IP2> <tx><rx><shared>

ip6 bandwidth del <IP1> /all

Syntax Description

Parameter	Description
<i>on</i>	It means to turn on bandwidth limit for each IP.
<i>off</i>	It means to turn off bandwidth limit for each IP.
<i>default <tx_rate> <rx_rate></i>	It means to set the default transmission (tx), receiving (rx) rate of bandwidth limit (0-30000 Kbps/Mbps). <tx_rate>: Enter a number. <rx_rate>: Enter a number.
<i>status</i>	It means to display the current settings.
<i>show</i>	It means to display all IP range bandwidth limit settings.
<i>add <IP1-IP2> <tx><rx><shared></i>	<add>: It means to add the bandwidth limit for an IPv6 range. : It means to delete the bandwidth limit for an IPv6 range by first IP (IP1) or 'del all'. <IP1-IP2> - Specify a range for IPv6 addresses. <tx><rx>: It means the bandwidth limit for transmission and receiving rate. <shared>: It means the bandwidth will be shared for the IPv6 range.
<i>del <IP1> /all</i>	It means to delete the bandwidth limit for an IPv6 range by first IP (IP1) or 'del all'.

<IP1> - Specify a range for IPv6 addresses. all: Delete all the bandwidth limits.
--

Example

```
> ip6 bandwidth on
> ip6 bandwidth add 2001:ABCD::2-2001:ABCD::10 512 5M shared
> ip6 bandwidth status

IPv6 range:
  2001:ABCD::2 - 2001:ABCD::10 : Tx:512K Rx:5M shared

Current ip6 Bandwidth limit is turn on

Current default ip6 Bandwidth rate is Tx:2000K Rx:8000K bps
> ip6 bandwidth del 2001:ABCD::2
>
```

Telnet Command: ipf view

IPF users to view the version of the IP filter, to view/set the log flag, to view the running IP filter rules.

Syntax

ipf view <-command/...>

Syntax Description

Parameter	Description
-V	It means to show the version of this IP filter.
-c	It means to show the running call filter rules.
-d	It means to show the running data filter rules.
-h	It means to show the hit-number of the filter rules.
-r	It means to show the running call and data filter rules.
-t	It means to display all the information at one time.
-Z	It means to clear a filter rule's statistics.
-Z	It means to clear IP filter's gross statistics.

Example

```
> ipf view -V -c -d
ipf: IP Filter: v3.3.1 (1824)
Kernel: IP Filter: v3.3.1
Running: yes
Log Flags: 0x80947278 = nonip
Default: pass all, Logging: available
```

Telnet Command: ipf flowtrack

This command is used to set and view flowtrack sessions.

Syntax

ipf flowtrack set -r

ipf flowtrack set -e

```
ipf flowtrack view -f
ipf flowtrack view -b
ipf flowtrack view -i <IP address> -p<value> -t<value> -f
```

Syntax Description

Parameter	Description
-r	It means to refresh the flowtrack.
-e	It means to enable or disable the flowtrack.
-f	It means to show the sessions state of flowtrack. If you do not specify any IP address, then all the session state of flowtrack will be displayed.
-b	It means to show all of IP sessions state.
<i>view -i <IP address> -p<port> -t <protocol> -f</i>	It means to show sessions state of flowtrack by specifying IP address (e.g., -i 192.168.2.55). <IP address>: Enter an IP address. <port>: Enter a number (0 ~ 65535). <protocol>: Enter tcp, udp or icmp.

Example

```
>ipf flowtrack set -r
Refresh the flowstate ok
> ipf flowtrack view -f
Start to show the flowtrack sessions state:

ORIGIN>> 192.168.1.11:59939 ->      8.8.8.8: 53 ,ifno=0
REPLY >>   8.8.8.8: 53 -> 192.168.1.11:59939 ,ifno=3
          proto=17, age=93023180(3920), flag=203
ORIGIN>> 192.168.1.11:15073 ->     8.8.8.8: 53 ,ifno=0
REPLY >>   8.8.8.8: 53 -> 192.168.1.11:15073 ,ifno=3
          proto=17, age=93025100(2000), flag=203
ORIGIN>> 192.168.1.11: 7247 ->     8.8.8.8: 53 ,ifno=0
REPLY >>   8.8.8.8: 53 -> 192.168.1.11: 7247 ,ifno=3
          proto=17, age=93020100(7000), flag=203
End to show the flowtrack sessions state
> ipf flowtrack set -e
Current flow_enable=0
> ipf flowtrack set -e
Curretn flow_enable=1
```

Telnet Command: Log

This command allows users to view log for WAN interface such as call log, IP filter log, flush log buffer, etc.

Syntax

```
log -<c/f/h/i/p/t/w/x> -F <a/c/f/w>
```

Syntax Description

Parameter	Description
-----------	-------------

<code>-c</code>	It means to show the latest call log.
<code>-f</code>	It means to show the IP filter log.
<code>-h</code>	It means to show this usage help.
<code>-p</code>	It means to show PPP/MP log.
<code>-t</code>	It means to show all logs saved in the log buffer.
<code>-w</code>	It means to show WAN log.
<code>-x</code>	It means to show packet body hex dump.
<code>-F <a/c/f/w></code>	It means to show the flush log buffer. a: flush all logs c: flush the call log f: flush the IP filter log w: flush the WAN log

Example

```
> log -w
0:00:05   DSL: DSL Channel = 0
0:00:05   DSL: VPI/VCI = 0/33
0:00:05   DSL: Mode = 1[PPPoE]
0:00:05   DSL: Encapsulation type = 1[LLC]
0:00:05   DSL: Modulation type = 4[MULTI]
```

Telnet Command: mngt ftpport

This command allows users to set FTP port for management.

Syntax

mngt ftpport <FTP port>

Syntax Description

Parameter	Description
<FTP port>	<FTP port>: Enter the number of FTP port. The default setting is 21.

Example

```
> mngt ftpport 21
% Set FTP server port to 21 done.
```

Telnet Command: mngt httpport

This command allows users to set HTTP port for management.

Syntax

mngt httpport <http port>

Syntax Description

Parameter	Description
<http port>	<http port>: Enter the number of HTTP port. The default setting is 80.

Example

```
> mngt httpport 80
% Set web server port to 80 done.
```

Telnet Command: mngt httpsport

This command allows users to set HTTPS port for management.

Syntax

```
mngt httpsport <https port>
```

Syntax Description

Parameter	Description
<https port>	<https port>: Enter the number for HTTPS port. The default setting is 443.

Example

```
> mngt httpsport 443
% Set web server port to 443 done.
```

Telnet Command: mngt telnetport

This command allows users to set telnet port for management.

Syntax

```
mngt telnetport <telnet port>
```

Syntax Description

Parameter	Description
<telnet port>	<telnet port>: Enter the number for telnet port. The default setting is 23.

Example

```
> mngt telnetport 23
% Set Telnet server port to 23 done.
```

Telnet Command: mngt sshport

This command allows users to set SSH port for management.

Syntax

```
mngt sshport <ssh port>
```

Syntax Description

Parameter	Description
<ssh port>	<ssh port>: Enter the number for SSH port. The default setting is 22.

Example

```
> mngt sshport 23
% Set ssh port to 23 done.
```

Telnet Command: mngt noping

This command is used to pass or block Ping from LAN PC to the internet.

Syntax

mngt noping *on*

mngt noping *off*

mngt noping *viewlog*

mngt noping *clearlog*

Syntax Description

Parameter	Description
<i>on</i>	All PING packets will be forwarded from LAN PC to Internet.
<i>off</i>	All PING packets will be blocked from LAN PC to Internet.
<i>viewlog</i>	It means to display a log of ping action, including source MAC and source IP.
<i>clearlog</i>	It means to clear the log of ping action.

Example

```
> mngt noping off
No Ping Packet Out is OFF!!
```

Telnet Command: mngt defenseworm

This command can block specified port for passing through the router.

Syntax

mngt defenseworm *on*

mngt defenseworm *off*

mngt defenseworm *add* <port>

mngt defenseworm *del* <port>

mngt defenseworm *viewlog*

mngt defenseworm *clearlog*

Syntax Description

Parameter	Description
<i>on</i>	It means to activate the function of defense worm packet out.
<i>off</i>	It means to inactivate the function of defense worm packet out.
<i>add</i> <port>	It means to add a new TCP port for block. <port>: Enter a port number.
<i>del</i> <port>	It means to delete a TCP port for block.

	<port>: Enter a port number.
<i>viewlog</i>	It means to display a log of defense worm packet, including source MAC and source IP.
<i>clearlog</i>	It means to remove the log of defense worm packet.

Example

```
> mngt defenseworm add 21
Add TCP port 21
Block TCP port list: 135, 137, 138, 139, 445, 21
> mngt defenseworm del 21
Delete TCP port 21
Block TCP port list: 135, 137, 138, 139, 445
```

Telnet Command: mngt rmtcfg

This command can allow the system administrators to login from the Internet. By default, it is not allowed.

Syntax

mngt rmtcfg status

mngt rmtcfg enable

mngt rmtcfg disable

mngt rmtcfg <http/https/ftp/telnet/ssh/tr069/enforce_https> <on/off>

Syntax Description

Parameter	Description
<i>status</i>	It means to display current setting for your reference.
<i>enable</i>	It means to allow the system administrators to login from the Internet.
<i>disable</i>	It means to deny the system administrators to login from the Internet.
<i><http/https/ftp/telnet/ssh/tr069/enforce_https> <on/off></i>	It means to specify one of the servers/protocols for enabling or disabling. <on> - enable the function. <off> - disable the function.

Example

```
> mngt rmtcfg ftp on
Enable server fail
Remote configure function has been disabled
please enable by enter mngt rmtcfg enable

> mngt rmtcfg enable
%% Remote configure function has been enabled.
> mngt rmtcfg ftp on
%% FTP server has been enabled.
```

Telnet Command: mngt lanaccess

This command allows users to manage accessing into Vigor router through LAN port.

Syntax

`mngt lanaccess -e <0/1> -s <value> -i <value>`

`mngt lanaccess -f`

`mngt lanaccess -d`

`mngt lanaccess -v`

`mngt lanaccess -h`

Syntax Description

Parameter	Description
<code>-e <0/1> -s <value> -i <value></code>	<p>-e: It means to enable/disable the function. <0/1>: Enter 0 or 1. 0,disable the function; 1, enable the function.</p> <p>-s <value>: It means to specify service offered. Enter FTP, HTTP, HTTPS, TELNET, SSH, None, or All.</p> <p>-i <value>: It means the interface which is allowed to access. Enter LAN2~LAN4, IP Routed Subnet, None, or All</p> <p>Note: LAN1 is always allowed for accessing into the router.</p>
<code>-f</code>	It means to flush all of the settings.
<code>-d</code>	It means to restore the factory default settings.
<code>-v</code>	It means to view current settings.
<code>-h</code>	It means to get the usage of such command.

Example

```
> mngt lanaccess -e 1
> mngt lanaccess -s FTP,TELNET
> mngt lanaccess -i LAN3
> mngt lanaccess -v
Current LAN Access Control Setting:
* Enable:Yes
* Service:
  - FTP:Yes
  - HTTP:No
  - HTTPS:No
  - TELNET:Yes
  - SSH:No
  - TR069:No
  - Enforce HTTPS:No
* Subnet:
  - LAN 1: enabled
  - Specific IP(IP object:0) is disabled
  - LAN 2: enabled
  - Specific IP(IP object:0) is disabled
  - IP Routed Subnet: enabled
  - Specific IP(IP object:0) is disabled
```

Telnet Command: mngt echoicmp

This command allows users to reject or accept PING packets from the Internet.

Syntax

mngt echoicmp *enable*
 mngt echoicmp *disable*

Syntax Description

Parameter	Description
<i>enable</i>	It means to accept the echo ICMP packet.
<i>disable</i>	It means to drop the echo ICMP packet.

Example

```
> mngt echoicmp enable
%% Echo ICMP packet enabled.
```

Telnet Command: mngt accesslist

This command allows you to specify that the system administrator can login from a specific host or network. A maximum of three IPs/subnet masks is allowed.

Syntax

mngt accesslist *list*
 mngt accesslist *add* <index><IP addr><mask>
 mngt accesslist *remove* <index>
 mngt accesslist *flush*

Syntax Description

Parameter	Description
<i>list</i>	It can display current setting for your reference.
<i>add</i> <index><IP addr><mask>	It means adding a new entry. <index>: Enter an index number of the entry. <IP addr>: Enter an IP address. <mask>: Enter the mask address.
<i>remove</i> <index>	It means to delete the selected item. <index>: Enter an index number of the entry.
<i>flush</i>	It means to remove all the settings in the access list.

Example

```
DrayTek> mngt accesslist add 2 192.168.2.76 255.255.255.0
%% Set OK.
> mngt accesslist list
DrayTek> mngt accesslist list
%% Access list :
  Index IP address      Subnet mask
  =====
  2     192.168.2.76     255.255.255.0
>
```

Telnet Command: mngt snmp

This command allows you to configure SNMP for management.

Syntax

mngt snmp -<command> <parameter> / ...

Syntax Description

Parameter	Description
<command> <parameter>/...	The available commands with parameters are listed below. [...] means that you can Enter several commands in one line.
-e <1/2>	1: Enable the SNMP function. 2: Disable the SNMP function.
-g <Community name>	It means to set the name for getting community by typing a proper character. (max. 23 characters) <Community name>: Enter a string.
-s <Community name>	It means to set community by typing a proper name. (max. 23 characters) <Community name>: Enter a string.
-m <IP address>	It means to set one host as the manager to execute SNMP function. Please Enter IPv4 address to specify certain host. <IP address>: Enter an IP address, or IP address with subnet, or manager host IP. Three IP addresses can be entered and separated by ','.
-t <Community name>	It means to set trap community by typing a proper name. (max. 23 characters) <Community name>: Enter a string.
-n <IP address>	It means to set the IPv4 address of the host that will receive the trap community. <IP address>: Enter an IP address, or IP address with subnet, or manager host IP. Two IP addresses can be entered and separated by ','.
-T <seconds>	It means to set the trap timeout. <seconds>: Enter a value (0-999)
-V	It means to list SNMP setting.

Example

```
> mngt snmp -e 1 -g draytek -s DK -m
192.168.1.20,192.168.5.192/26,10.20.3.40/24 -t trapcom -n
192.168.1.20,10.20.3.40 -T 88
SNMP Agent Turn on!!!
Get Community set to draytek
Set Community set to DK
Manager Host IP set to 192.168.1.20,192.168.5.192/26,10.20.3.40/24
Trap Community set to trapcom
Notification Host IP set to 192.168.1.20,10.20.3.40
Trap Timeout set to 88 seconds
>
```

Telnet Command: msubnet switch

This command is used to configure multi-subnet.

Syntax

`msubnet switch <2> <On/Off>`

Syntax Description

Parameter	Description
<2>	It means LAN interface. 2=LAN2
<On/Off>	On means turning on the subnet for the specified LAN interface. Off means turning off the subnet.

Example

```
> msubnet switch 2 On
% LAN2      Subnet On!

This setting will take effect after rebooting.
Please use "sys reboot" command to reboot the router.
```

Telnet Command: msubnet addr

This command is used to configure IP address for the specified LAN interface.

Syntax

`msubnet addr <2><IP address>`

Syntax Description

Parameter	Description
<2>	It means LAN interface.
<IP address>	Enter the private IP address for the specified LAN interface.

Example

```
> msubnet addr 2 192.168.5.1
% Set LAN2 subnet IP address done !!!

This setting will take effect after rebooting.
Please use "sys reboot" command to reboot the router.
```

Telnet Command: msubnet nmask

This command is used to configure net mask address for the specified LAN interface.

Syntax

`msubnet nmask <2><IP address>`

Syntax Description

Parameter	Description
-----------	-------------

<2>	It means LAN interface.
<IP address>	Enter the subnet mask address for the specified LAN interface.

Example

```
> msubnet nmask 2 255.255.0.0
% Set LAN2 subnet mask done !!!

This setting will take effect after rebooting.
Please use "sys reboot" command to reboot the router.
```

Telnet Command: msubnet status

This command is used to display current status of subnet.

Syntax

msubnet status <2>

Syntax Description

Parameter	Description
<2>	It means LAN interface.

Example

```
> msubnet status 2
% LAN2 Off: 0.0.0.0/0.0.0.0, PPP Start IP: 0.0.0.60
% DHCP server: Off
% Dhcp Gateway: 0.0.0.0, Start IP: 0.0.0.10, Pool Count: 50
```

Telnet Command: msubnet dhcps

This command allows you to enable or disable DHCP server for the subnet.

Syntax

msubnet dhcps <2> <On/Off>

Syntax Description

Parameter	Description
<2>	It means LAN interface.
<On/Off>	On means enabling the DHCP server for the specified LAN interface. Off means disabling the DHCP server.

Example

```
> msubnet dhcps 3 off
% LAN3 Subnet DHCP Server disabled!

This setting will take effect after rebooting.
Please use "sys reboot" command to reboot the router.
```

Telnet Command: msubnet nat

This command is used to configure the subnet for NAT or Routing usage.

Syntax

msubnet nat <2> <On/Off>

Syntax Description

Parameter	Description
<2>	It means LAN interface.
<On/Off>	On - It means the subnet will be configured for NAT usage. Off - It means the subnet will be configured for Routing usage.

Example

```
> > msubnet nat 2 off
% LAN2 Subnet is for Routing usage!
%Note: If you have multiple WAN connections, please be reminded to setup a
Load-Balance policy so that packets from this subnet will be forwarded to the
right WAN interface!

This setting will take effect after rebooting.
Please use "sys reboot" command to reboot the router.
```

Telnet Command: msubnet gateway

This command is used to configure an IP address as the gateway used for subnet.

Syntax

msubnet gateway <2><Gateway IP>

Syntax Description

Parameter	Description
<2>	It means LAN interface.
<Gateway IP>	Specify an IP address as the gateway IP.

Example

```
> msubnet gateway 2 192.168.1.13
% Set LAN2 Dhcp Gateway IP done !!!

This setting will take effect after rebooting.
Please use "sys reboot" command to reboot the router.
```

Telnet Command: msubnet ipcnt

This command is used to defined the total number allowed for each LAN interface.

Syntax

msubnet ipcnt <2><IP counts>

Syntax Description

Parameter	Description
<2>	It means LAN interface.
<IP counts>	Specify a total number of IP address allowed for each LAN interface. The available range is from 0 to 220.

Example

```
> msubnet ipcnt 2 15
This setting will take effect after rebooting.
Please use "sys reboot" command to reboot the router.
```

Telnet Command: msubnet talk

This command is used to establish a route between two LAN interfaces.

Syntax

```
msubnet talk <1/2> <1/2> <On/Off>
```

Syntax Description

Parameter	Description
<1/2><1/2>	It means LAN interface. 1: LAN1 2: LAN2
<On/Off>	On: It means to establish a route. Off: It means Not to establish a route.

Example

```
> msubnet talk 1 2 on
> msubnet talk 1 2 on
% Enable routing between LAN1 and LAN2!

This setting will take effect after rebooting.
Please use "sys reboot" command to reboot the router.

> msubnet talk
% msubnet talk <1/2> <1/2> <On/Off>
% where 1:LAN1, 2:LAN2
% Now:
%           LAN1  LAN2
% LAN1      V
% LAN2      V   V
DrayTek>
>
```

Telnet Command: msubnet startip

This command is used to configure a starting IP address for DHCP.

Syntax

```
msubnet startip <2><Gateway IP>
```

Syntax Description

Parameter	Description
<2>	It means LAN interface. 2: LAN2
<Gateway IP>	Type an IP address as the starting IP address for a subnet.

Example

```
> msubnet startip 2 192.168.2.90
%Set LAN2 Dhcp Start IP done !!!

This setting will take effect after rebooting.
Please use "sys reboot" command to reboot the router.
> msubnet startip ?
% msubnet startip <2/3/4> <Gateway IP>
% Now: LAN2 192.168.2.90; LAN3 192.168.3.10; LAN4 192.168.4.10; LAN5
192.168.5.1
0; LAN6 192.168.6.10
```

Telnet Command: msubnet pppip

This command is used to configure a starting IP address for PPP connection.

Syntax

msubnet pppip <2><Start IP>

Syntax Description

Parameter	Description
<2>	It means LAN interface. 2: LAN2
<Start IP>	Type an IP address as the starting IP address for PPP connection.

Example

```
> msubnet pppip 2 192.168.2.250
% Set LAN2 PPP(IPCP) Start IP done !!!

This setting will take effect after rebooting.
Please use "sys reboot" command to reboot the router

> msubnet pppip
% msubnet pppip <2> <Start IP>
% Now: LAN2 192.168.2.250

>
```

Telnet Command: msubnet nodetype

This command is used to specify the type for node which is required by DHCP option.

Syntax

msubnet nodetype <2><count>

Syntax Description

Parameter	Description
<2>	It means LAN interface. 2=LAN2
<count>	Choose the following number for specifying different node type. 1: B-node 2: P-node 4: M-node 8: H-node 0: Not specify any type for node.

Example

```
> msubnet nodetype 2 1
% Set LAN2 Dhcp Node Type done !!!

> msubnet nodetype
% msubnet nodetype <2> <count>
% Now: LAN2 1

% count: 1. B-node 2. P-node 4. M-node 8. H-node
```

Telnet Command: msubnet primWINS

This command is used to configure primary WINS server.

Syntax

msubnet primWINS <2><WINS IP>

Syntax Description

Parameter	Description
<2>	It means LAN interface. 2:LAN2
<WINS IP>	Enter the IP address as the WINS IP.

Example

```
> msubnet primWINS ?
% msubnet primWINS <2> <WINS IP>
% Now: LAN2 0.0.0.0
> msubnet primWINS 2 192.168.3.5
% Set LAN2 Dhcp Primary WINS IP done !!!

> msubnet primWINS
% msubnet primWINS <2> <WINS IP>
% Now: LAN2 192.168.3.5
```

Telnet Command: msubnet secWINS

This command is used to configure secondary WINS server.

Syntax

`msubnet secWINS <2><WINS IP>`

Syntax Description

Parameter	Description
<2>	It means LAN interface. 2:LAN2
<WINS IP>	Enter the IP address as the WINS IP.

Example

```
> msubnet secWINS 2 192.168.3.89
% Set LAN2 Dhcp Secondary WINS IP done !!!

> msubnet secWINS
% msubnet secWINS <2> <WINS IP>
% Now: LAN2 192.168.3.89
```

Telnet Command: msubnet tftp

This command is used to set TFTP server for multi-subnet.

Syntax

`msubnet tftp <2><TFTP server name>`

Syntax Description

Parameter	Description
<2>	It means LAN interface. 2:LAN2
<TFTP server name>	Type a name to indicate the TFTP server.

Example

```
> msubnet tftp ?
% msubnet tftp <2> <TFTP server name>
% Now: LAN2

> msubnet tftp 2 publish
% Set LAN2 TFTP Server Name done !!!

> msubnet tftp
% msubnet tftp <2> <TFTP server name>
% Now: LAN2 publish
```

Telnet Command: msubnet mtu

This command allows you to configure MTU value for LAN/DMZ/IP Routed Subnet.

Syntax

`msubnet mtu <interface> <value>`

Syntax Description

Parameter	Description
<i><interface></i>	Available settings include LAN1~LAN2, IP_Routed_Subnet.
<i><value></i>	<i><value></i> : Enter a number (1000 ~ 1500(Bytes)). Default value is 1500.

Example

```

> msubnet mtu LAN1 1492
Set LAN1 subnet mtu as 1492
> msubnet mtu
Usage:

>msubnet mtu <interface> <value>

<interface>: LAN1~LAN2,IP_Routed_Subnet, <value>: 1000 ~ 1500 (Bytes),
de
fault: 1500 (Bytes)

e.x: >msubnet mtu LAN1 1492

Current Settings:

LAN1 MTU: 1492 (Bytes)
LAN2 MTU: 1500 (Bytes)
IP Routed Subnet MTU: 1500 (Bytes)

```

Telnet Command: msubnet leasetime

This command allows you to configure lease time for LAN interface.

Syntax

msubnet leasetime *<1/2>* *<Lease Time <sec.>>*

Syntax Description

Parameter	Description
<i><1/2></i>	Available settings include 1: LAN1 2: LAN2
<i><Lease Time <sec.>></i>	<i><lease time></i> : Enter a number (10 ~ 2592000). Default value is 86400.

Example

```

> msubnet leasetime 1 3000000
% Invalid lease time input (Valid: 10 to 2592000 ) !!!
% Now: 86400

> msubnet leasetime 1 92000
% Set LAN1 lease time: 92000

```

>

Telnet Command: object ip obj

This command is used to create an IP object profile.

Syntax

object ip obj setdefault

object ip obj *INDEX -v*

object ip obj *INDEX -n NAME*

object ip obj *INDEX -i INTERFACE*

object ip obj *INDEX -s INVERT*

object ip obj *INDEX -a TYPE <START_IP><END/MASK_IP>*

Syntax Description

Parameter	Description
<i>setdefault</i>	It means to return to default settings for all profiles.
<i>INDEX -v</i>	It means to view the information of the specified object profile. INDEX: Enter the index number of the specified group profile. Example: <i>object ip obj 1 -v</i>
<i>INDEX -n NAME</i>	It means to define a name for the IP object. INDEX: Enter the index number of the specified group profile. NAME: Enter a name with less than 15 characters. Example: <i>object ip obj 9 -n bruce</i>
<i>INDEX -i INTERFACE</i>	It means to define an interface for the IP object. INDEX: Enter the index number of the specified group profile. INTERFACE: Enter 0, 1, 3 0, means any 1, means LAN 3, means WAN Example: <i>object ip obj 8 -i 0</i>
<i>INDEX -s INVERT</i>	It means to set invert selection for the object profile. INDEX: Enter the index number of the specified group profile. INVERT: Enter 0, 1 0, means disableing the function. 1, means enabling the function. Example: <i>object ip obj 3 -s 1</i>
<i>INDEX -a TYPE <START_IP> <END/MASK_IP></i>	It means to set the address type and IP for the IP object profile. INDEX: Enter the index number of the specified group profile. TYPE: Enter 0, 1, 2, 3 or 4 0, means Mask 1, means Single 2, means Any 3, means Rang 4, means Mac Example: <i>object ip obj 3 -a 2</i> <START_IP>: When the TYPE is set with 2, you have to type an IP address as a starting point and another IP address as

	end point. <END/MASK_IP>: Enter an IP address (different with START_IP) as the end IP address.
--	---

Example

```
> object ip obj 1 -n marketing
OK.

> object ip obj 1 -a 1 192.168.1.45
OK.

> object ip obj 1 -v
IP Object Profile 1
Name      :[marketing]
Interface:[Any]
Address type:[single]
Start ip address:[192.168.1.45]
End/Mask ip address:[0.0.0.0]
MAC Address:[00:00:00:00:00:00]
Invert Selection:[0]
```

Telnet Command: object ip grp

This command is used to integrate several IP objects under an IP group profile.

Syntax

`object ip grp setdefault`

`object ip grp INDEX -v`

`object ip grp INDEX -n NAME`

`object ip grp INDEX -i INTERFACE`

`object ip grp INDEX -a IP_OBJ_INDEX`

Syntax Description

Parameter	Description
<i>setdefault</i>	It means to return to default settings for all profiles.
<i>INDEX -v</i>	It means to view the information of the specified group profile. INDEX: Enter the index number of the specified group profile. Example: <i>object ip grp 1 -v</i>
<i>INDEX -n NAME</i>	It means to define a name for the IP group. INDEX: Enter the index number of the specified group profile. NAME: Type a name with less than 15 characters. Example: <i>object ip grp 8 -n bruce</i>
<i>INDEX -i INTERFACE</i>	It means to define an interface for the IP group. INDEX: Enter the index number of the specified group profile. INTERFACE: Enter 0, 1 or 3 0, means any 1, means LAN 3, means WAN Example: <i>object ip grp 3 -i 0</i>
<i>INDEX -a IP_OBJ_INDEX</i>	It means to specify IP object profiles for the group profile. INDEX: Enter the index number of the specified group

	profile. IP_OBJ_INDEX: Enter the index number of object profiles. Example: <code>:object ip grp 3 -a 1 2 3 4 5</code> The IP object profiles with index number 1,2,3,4 and 5 will be group under such profile.
--	---

Example

```
> object ip grp 2 -n First
IP Group Profile 2
Name      :[First]
Interface:[Any]
Included ip object index:
[0:][0]
[1:][0]
[2:][0]
[3:][0]
[4:][0]
[5:][0]
[6:][0]
[7:][0]
[8:][0]
[9:][0]
[10:][0]
[11:][0]

> object ip grp 2 -a 1 2
IP Group Profile 2
Name      :[First]
Interface:[Lan]
Included ip object index:
[0:][0]
[1:][0]
[2:][0]
[3:][0]
[4:][0]
[5:][0]
[6:][0]
[7:][0]
[8:][0]
[9:][0]
[10:][0]
[11:][0]

Set ok!
```

Telnet Command: object ipv6 obj

This command is used to create an IPv6 object profile.

Syntax

object ipv6 obj *setdefault*

object ipv6 obj *INDEX -v*

object ipv6 obj *INDEX -n NAME*

object ipv6 obj *INDEX -s INVERT*

object ipv6 obj *INDEX -e MATCH_TYPE*

object ipv6 obj *INDEX -a TYPE <START_IP> <END_IP>/<Prefix Length>*

Syntax Description

Parameter	Description
<i>setdefault</i>	It means to return to default settings for all profiles.
<i>INDEX -v</i>	It means to view the information of the specified object profile. INDEX: Enter the index number of the specified object profile. Example: <i>object ipv6 obj 1 -v</i>
<i>INDEX -n NAME</i>	It means to define a name for the IPv6 object. NAME: Type a name with less than 15 characters. Example: <i>object ipv6 obj 9 -n bruce</i>
<i>INDEX -s INVERT</i>	It means to set invert selection for the object profile. INVERT: Enter 0 or 1. 0, means disabling the function. 1, means enabling the function. Example: <i>object ipv6 obj 3 -s 1</i>
<i>INDEX -e MATCH_TYPE</i>	It means to set the match type of ipv6 object profile. MATCH_TYPE: Enter 0 or 1. 0:128 Bits, 1:Suffix 64 Bits Interface ID
<i>INDEX -a TYPE <START_IP> <END_IP>/<Prefix Length></i>	It means to set the address type for the IPv6 object profile. TYPE: Enter 0, 1, 2, 3, or 4 0, means Mask 1, means Single 2, means Any 3, means Rang 4, means Mac Example: <i>object ipv6 obj 3 -a 2</i> <START_IP>: When the TYPE is set with 2, you have to type an IPv6 address as a starting point and another IP address as end point. Enter an IPv6 address as the starting point. <END_IP>/ <Prefix Length>: Enter an IPv6 address (different with START_IP) as the end IPv6 address or the prefix length of the IPv6 address.

Example

```
> object ipv6 obj 9 -n bruce
Setting saved.

> object ipv6 obj 3 -s 1
Setting saved.
```

```

> object ipv6 obj 3 -e 1
You can not set 64 bits Interface ID for Subnet type.

Setting saved.

> object ipv6 obj 3 -a 3 2607:f0d0:1002:51::4 2607:f0d0:1002:51::4
Setting saved.

> object ipv6 obj 3 -v
IPv6 Object Profile 3
Name      :[]
Address Type:[range]
Start IPv6 Address:[2607:F0D0:1002:51::4]
End IPv6 Address:[2607:F0D0:1002:51::4]
Prefix Length:[0]
MAC Address:[00:00:00:00:00:00]
Invert Selection:[0]
Match Type:[0]

```

Telnet Command: object ipv6 grp

This command is used to integrate several IPv6 objects under an IPv6 group profile.

Syntax

```

object ipv6 grp setdefault
object ipv6 grp INDEX -v
object ipv6 grp INDEX -n NAME
object ipv6 grp INDEX -a IP_OBJ_INDEX

```

Syntax Description

Parameter	Description
<i>setdefault</i>	It means to return to default settings for all profiles.
<i>INDEX -v</i>	It means to view the information of the specified group profile. INDEX: Enter the index number of the specified group profile. Example: <i>object ipv6 grp 1 -v</i>
<i>INDEX -n NAME</i>	It means to define a name for the IPv6 group. INDEX: Enter the index number of the specified group profile. NAME: Type a name with less than 15 characters. Example: <i>object ipv6 grp 8 -n bruce</i>
<i>INDEX -a IP_OBJ_INDEX</i>	It means to specify IPv6 object profiles for the group profile. INDEX: Enter the index number of the specified group profile. IP_OBJ_INDEX: Enter the index number of object profiles. Example: <i>:object ipv6 grp 3 -a 1 2 3 4 5</i> The IPv6 object profiles with index number 1,2,3,4 and 5 will be group under such profile.

Example

```

> object ipv6 grp 8 -n bruce
IPv6 Group Profile 8
Name      :[bruce]
Included ip object index:

```

```

[0:][0]
[1:][0]
[2:][0]
[3:][0]
[4:][0]
[5:][0]
[6:][0]
[7:][0]
> object ipv6 grp 8 -a 1 2 3 4 5
IPv6 Group Profile 8
Name      :[bruce]
Included ip object index:
[0:][1]
[1:][2]
[2:][3]
[3:][4]
[4:][5]
[5:][0]
[6:][0]
[7:][0]

```

Telnet Command: object service obj

This command is used to create service object profile.

Syntax

- object service obj *setdefault*
- object service obj *INDEX -v*
- object service obj *INDEX -n NAME*
- object service obj *INDEX -p PROTOCOL*
- object service obj *INDEX -s CHK <START_P><END_P>*
- object service obj *INDEX -d CHK <START_P><END_P>*

Syntax Description

Parameter	Description
<i>setdefault</i>	It means to return to default settings for all profiles.
<i>INDEX -v</i>	It means to view the information of the specified service object profile. INDEX: Enter the index number of the specified service object profile. Example: <i>object service obj 1 -v</i>
<i>INDEX -n NAME</i>	It means to define a name for the IP object. INDEX: Enter the index number of the specified service object profile. NAME: Type a name with less than 15 characters. Example: <i>object service obj 9 -n bruce</i>
<i>INDEX -p PROTOCOL</i>	It means to define a PROTOCOL for the service object profile. INDEX: Enter the index number of the specified service object profile. PROTOCOL: Enter 0, 1, 2, 6, 17, 58, 255, others 0, means any 1, means ICMP 2, means IGMP 6, means TCP 17, means UDP

	<p>58, means ICMPv6 255, means TCP/UDP Other values mean other protocols. Example: <i>object service obj 8 -p 1</i></p>
<p><i>INDEX -s CHK</i> <START_P><END_P></p>	<p>It means to set source port check and configure port range (1~65565) for TCP/UDP. INDEX: Enter the index number of the specified service object profile. CHK: Enter 0, 1, 2, or 3 0, means equal(=), when the starting port and ending port values are the same, it indicates one port; when the starting port and ending port values are different, it indicates a range for the port and available for this service type. 1, means not equal(!=), when the starting port and ending port values are the same, it indicates all the ports except the port defined here; when the starting port and ending port values are different, it indicates that all the ports except the range defined here are available for this service type. 2, means larger(>), the port number greater than this value is available. 3, means less(<), the port number less than this value is available for this profile. <START_P>: Enter a number as starting port number. <END_P>: Enter a port number as the ending port number. Example: <i>object service obj 3 -s 0 100 200</i></p>
<p><i>INDEX -d CHK</i> <START_P><END_P></p>	<p>It means to set destination port check and configure port range (1~65565) for TCP/UDP. INDEX: Enter the index number of the specified service object profile. CHK: Enter 0, 1, 2, or 3 0, means equal(=), when the starting port and ending port values are the same, it indicates one port; when the starting port and ending port values are different, it indicates a range for the port and available for this service type. 1, means not equal(!=), when the starting port and ending port values are the same, it indicates all the ports except the port defined here; when the starting port and ending port values are different, it indicates that all the ports except the range defined here are available for this service type. 2, means larger(>), the port number greater than this value is available. 3, means less(<), the port number less than this value is available for this profile. <START_P>: Enter a number as starting port number. <END_P>: Enter a port number as the ending port number. Example: <i>object service obj 3 -d 1 100 200</i></p>

Example

```

> object service obj 1 -n limit
> object service obj 1 -p 255
> object service obj 1 -s 1 120 240
> object service obj 1 -d 1 200 220
> object service obj 1 -v
Service Object Profile 1
Name      :[limit]

```

```

Protocol:[TCP/UDP]
Source port check action:[!=]
Source port range:[120~240]
Destination port check action:[!=]
Destination port range:[200~220]
>

```

Telnet Command: object service grp

This command is used to integrate several service objects under a service group profile.

Syntax

`object service grp setdefault`

`object service grp INDEX -v`

`object service grp INDEX -n NAME`

`object service grp INDEX -a SER_OBJ_INDEX`

Syntax Description

Parameter	Description
<i>setdefault</i>	It means to return to default settings for all profiles.
<i>INDEX -v</i>	It means to view the information of the specified service group profile. INDEX: Enter the index number of the specified group profile. Example: <i>object service grp 1 -v</i>
<i>INDEX -n NAME</i>	It means to define a name for the service group. INDEX: Enter the index number of the specified service group profile. NAME: Type a name with less than 15 characters. Example: <i>object service grp 8 -n bruce</i>
<i>INDEX -a SER_OBJ_INDEX</i>	It means to specify service object profiles for the group profile. INDEX: Enter the index number of the specified service group profile. SER_OBJ_INDEX: Enter the index number of the service object profile. Example: <i>:object service grp 3 -a 1 2 3 4 5</i> The service object profiles with index number 1,2,3,4 and 5 will be group under such profile.

Example

```

> object service grp 1 -n group_1
Service Group Profile 1
Name   :[group_1]
Included service object index:
[0:][0]
[1:][0]
[2:][0]
[3:][0]
[4:][0]
[5:][0]
[6:][0]
[7:][0]
>object service grp 1 -a 1 2
Service Group Profile 1

```

```
Name      :[Grope_1]
Included service object index:
[0:][1]
[1:][2]
[2:][0]
[3:][0]
[4:][0]
[5:][0]
[6:][0]
[7:][0]
```

Telnet Command: object kw

This command is used to create keyword profile.

Syntax

```
object kw obj setdefault
object kw obj show
object kw obj show PAGE
object kw obj INDEX -v
object kw obj INDEX -n NAME
object kw obj INDEX -a CONTENTS
object kw obj INDEX -c
```

Syntax Description

Parameter	Description
<i>setdefault</i>	It means to return to default settings for all profiles.
<i>show</i>	It means to show the contents for all of the profiles.
<i>show PAGE</i>	It means to show the contents of the specified profile. PAGE: Enter the page number.
<i>INDEX -v</i>	It means to view the information of the specified keyword profile. INDEX: Enter the index number of the specified keyword profile.
<i>INDEX -n NAME</i>	It means to define a name for the keyword profile. INDEX: Enter the index number of the specified keyword profile. NAME: Enter a name with less than 15 characters as the keyword profile.
<i>INDEX -a CONTENTS</i>	It means to set the contents for the keyword profile. INDEX: Enter the index number of the specified keyword profile. CONTENTS: Enter a string as the content of the keyword profile. Example: <i>object kw obj 40 -a test</i>
<i>INDEX -c</i>	It means to clear the contents of keyword object profile. INDEX: Enter the index number of the specified keyword profile.

Example

```
> object kw obj 1 -n children
Profile 1
Name      :[children]
Content:[]
```

```

> object kw obj 1 -a gambling
Profile 1
Name   :[children]
Content:[gambling]

> object kw obj 1 -v
Profile 1
Name   :[children]
Content:[gambling]

```

Telnet Command: object fe

This command is used to create File Extension Object profile.

Syntax

`object fe show`

`object fe setdefault`

`object fe obj INDEX -v`

`object fe obj INDEX -n NAME`

`object fe obj INDEX -e CATEGORY/FILE_EXTENSION`

`object fe obj INDEX -d CATEGORY/FILE_EXTENSION`

Syntax Description

Parameter	Description
<i>show</i>	It means to show the contents for all of the profiles.
<i>setdefault</i>	It means to return to default settings for all profiles.
<i>INDEX -v</i>	It means to view the information of the specified file extension object profile. INDEX: Enter the index number (from 1 to 8) of the specified file extension object profile.
<i>INDEX -n NAME</i>	It means to define a name for the file extension object profile. INDEX: Enter the index number (from 1 to 8) of the specified file extension object profile. NAME: Type a name with less than 15 characters.
<i>INDEX -e CATEGORY/FILE_EXTENSION</i>	It means to enable the specific CATEGORY or FILE_EXTENSION. INDEX: Enter the index number (from 1 to 8) of the specified file extension object profile. CATEGORY: Image, Video, Audio, Java, ActiveX, Compression, Execution Example: <i>object fe obj 1 -e Image</i> FILE_EXTENSION: ".bmp", ".dib", ".gif", ".jpeg", ".jpg", ".jpg2", ".jp2", ".pct", ".pcx", ".pic", ".pict", ".png", ".tif", ".tiff", ".asf", ".avi", ".mov", ".mpe", ".mpeg", ".mpg", ".mp4", ".qt", ".rm", ".wmv", ".3gp", ".3gpp", ".3gpp2", ".3g2", ".flv", ".swf", ".aac", ".aiff", ".au", ".mp3", ".m4a", ".m4p", ".ogg", ".ra", ".ram", ".vox", ".wav", ".wma", ".class", ".jad", ".jar", ".jav", ".java", ".jcm", ".js", ".jse", ".jsp", ".jtk", ".alx", ".apb", ".axs", ".ocx", ".olb", ".ole", ".tlb", ".viv", ".vrm", ".ace", ".arj", ".bz2", ".bz2", ".cab", ".gz", ".gzip", ".rar", ".sit", ".zip", ".bas", ".bat", ".com", ".exe", ".inf", ".pif", ".reg", ".scr", ".torrent" Example: <i>object fe obj 1 -e .bmp</i>
<i>INDEX -d</i>	It means to disable the specific CATEGORY or

<p>CATEGORY/FILE_EXTENSION ON</p>	<p>FILE_EXTENSION. INDEX: Enter the index number (from 1 to 8) of the specified file extension object profile. CATEGORY: Image, Video, Audio, Java, ActiveX, Compression, Execution Example: <i>object fe obj 1 -e Image</i> FILE_EXTENSION: ".bmp", ".dib", ".gif", ".jpeg", ".jpg", ".jpg2", ".jp2", ".pct", ".pcx", ".pic", ".pict", ".png", ".tif", ".tiff", ".asf", ".avi", ".mov", ".mpe", ".mpeg", ".mpg", ".mp4", ".qt", ".rm", ".wmv", ".3gp", ".3gpp", ".3gpp2", ".3g2", ".flv", ".swf", ".aac", ".aiff", ".au", ".mp3", ".m4a", ".m4p", ".ogg", ".ra", ".ram", ".vox", ".wav", ".wma", ".class", ".jad", ".jar", ".jav", ".java", ".jcm", ".js", ".jse", ".jsp", ".jtk", ".alx", ".apb", ".axs", ".ocx", ".olb", ".ole", ".tlb", ".viv", ".vrm", ".ace", ".arj", ".bzip2", ".bz2", ".cab", ".gz", ".gzip", ".rar", ".sit", ".zip", ".bas", ".bat", ".com", ".exe", ".inf", ".pif", ".reg", ".scr", ".torrent" Example: <i>object fe obj 1 -e .bmp</i></p>
---	---

Example

```

> object fe obj 1 -n music
> object fe obj 1 -e Audio
> object fe obj 1 -v
Profile Index: 1
Profile Name:[music]

-----
Image category:
[ ].bmp [ ].dib [ ].gif [ ].jpeg [ ].jpg [ ].jpg2 [ ].jp2 [ ].pct
[ ].pcx [ ].pic [ ].pict [ ].png [ ].tif [ ].tiff
-----
Video category:
[ ].asf [ ].avi [ ].mov [ ].mpe [ ].mpeg [ ].mpg [v].mp4 [ ].qt
[ ].rm [v].wmv [ ].3gp [ ].3gpp [ ].3gpp2 [ ].3g2
-----
Audio category:
[v].aac [v].aiff [v].au [v].mp3 [v].m4a [v].m4p [v].ogg [v].ra
[v].ram [v].vox [v].wav [v].wma
-----
Java category:
[ ].class [ ].jad [ ].jar [ ].jav [ ].java [ ].jcm [ ].js [ ].jse
[ ].jsp [ ].jtk
-----
ActiveX category:
[ ].alx [ ].apb [ ].axs [ ].ocx [ ].olb [ ].ole [ ].tlb [ ].viv
[ ].vrm
-----
Compression category:
[ ].ace [ ].arj [ ].bzip2 [ ].bz2 [ ].cab [ ].gz [ ].gzip [ ].rar
[ ].sit [ ].zip
-----
Execution category:
[ ].bas [ ].bat [ ].com [ ].exe [ ].inf [ ].pif [ ].reg [ ].scr

```

Telnet Command: object sms

This command is used to create short message object profile.

Syntax

object sms show

object sms setdefault

object sms obj *INDEX -v*

object sms obj *INDEX -n NAME*

object sms obj *INDEX -s Service Provider*

object sms obj *INDEX -u Username*

object sms obj *INDEX -p Password*

object sms obj *INDEX -q Quota*

object sms obj *INDEX -i Interval*

object sms obj *INDEX -l URL*

Syntax Description

Parameter	Description
<i>show</i>	It means to show the contents for all of the profiles.
<i>setdefault</i>	It means to return to default settings for all profiles.
<i>INDEX -v</i>	It means to view the information of the specified SMS object profile. INDEX: Enter the index number (from 1 to 10) of the specified SMS object profile.
<i>INDEX -n NAME</i>	It means to define a name for the SMS object profile. INDEX: Enter the index number (from 1 to 10) of the specified SMS object profile. NAME: Enter a name with less than 15 characters as SMS object profile name.
<i>INDEX -s Service Provider</i>	It means to specify the number of the service provider which offers the service of SMS. Different numbers represent different service provider. INDEX: Enter the index number (from 1 to 10) of the specified SMS object profile. Service Provider: Enter 0, 2, 4, 5, 6, 7, 8, 9, 10, 11, 12, 13 or 14 0 : kotsms.com.tw (TW) 2 : textmarketer.co.uk (UK) 4 : messagemedia.co.uk (UK) 5 : bulksms.com (INT) 6 : bulksms.co.uk (UK) 7 : bulksms.2way.co.za (ZA) 8 : bulksms.com.es (ES) 9 : usa.bulksms.com (US) 10 : bulksms.de (DE) 11 : www.pswin.com (EU) 12 : www.messagebird.com (EU) 13 : www.lusosms.com (EU) 14 : www.vibeactivemedia.com (UK)
<i>INDEX -u Username</i>	It means to define a user name for the SMS object profile. INDEX: Enter the index number (from 1 to 10) of the specified SMS object profile. Username: Enter a user name that the sender can use to register to selected SMS provider.
<i>INDEX -p Password</i>	It means to define a password for the SMS object profile.

	INDEX: Enter the index number (from 1 to 10) of the specified SMS object profile. Password: Enter a password that the sender can use to register to selected SMS provider.
<i>INDEX -q Quota</i>	Enter the number of the credit that you purchase from the service provider. INDEX: Enter the index number (from 1 to 10) of the specified SMS object profile. Quota: Enter a number. Note that one credit equals to one SMS text message on the standard route.
<i>INDEX -I Interval</i>	It means to set the sending interval for the SMS to be delivered. INDEX: Enter the index number (from 1 to 10) of the specified SMS object profile. Interval: Enter the shortest time interval for the system to send SMS.
<i>INDEX -I URL</i>	It means to set the URL of SMS object profile 9 and 10. INDEX: Enter the index number (from 1 to 10) of the specified SMS object profile. URL: Enter the URL of SMS object.

Example

```

> object sms obj 1 -n CTC
> object sms obj 1 -n CTC
> object sms obj 1 -s 0
> object sms obj 1 -u carrie
> object sms obj 1 -p 19971125cm
> object sms obj 1 -q 2
> object sms obj 1 -i 50
> object sms obj 1 -v
Profile Index: 1
Profile Name:[CTC]
SMS Provider:[kotsms.com.tw (TW)]
Username:[carrie]
Password:[*****]
Quota:[2]
Sending Interval:[50(seconds)]

```

Telnet Command: object mail

This command is used to create mail object profile.

Syntax

```

object mail show
object mail setdefault
object mail obj INDEX -v
object mail obj INDEX -n Profile Name
object mail obj INDEX -s SMTP Server
object mail obj INDEX -I Use SSL
object mail obj INDEX -m SMTP Port
object mail obj INDEX -a Sender Address
object mail obj INDEX -t Authentication
object mail obj INDEX -u Username
object mail obj INDEX -p Password

```

object mail obj *INDEX -i Sending Interval*

Syntax Description

Parameter	Description
<i>show</i>	It means to show the contents for all of the profiles.
<i>setdefault</i>	It means to return to default settings for all profiles.
<i>INDEX -v</i>	It means to view the information of the specified mail object profile. INDEX: Enter the index number (from 1 to 10) of the specified mail object profile.
<i>INDEX -n Profile Name</i>	It means to define a name for the mail object profile. INDEX: Enter the index number (from 1 to 10) of the specified mail object profile. Profile Name: Enter a name with less than 15 characters.
<i>INDEX -s SMTP Server</i>	It means to set the IP address of the mail server. INDEX: Enter the index number (from 1 to 10) of the specified mail object profile. SMTP Server: Enter the name or the IP address of the SMTP server.
<i>INDEX -I Use SSL</i>	It means to use port 465 for SMTP server for some e-mail server uses https as the transmission method. INDEX: Enter the index number (from 1 to 10) of the specified mail object profile. Use SSL: Enter 0 or 1. 0 - disable 1 - enable to use the port number.
<i>INDEX -m SMTP Port</i>	It means to set the port number for SMTP server. INDEX: Enter the index number (from 1 to 10) of the specified mail object profile. SMTP Port: Enter a port number.
<i>INDEX -a Sender Address</i>	It means to set the e-mail address of the sender. INDEX: Enter the index number (from 1 to 10) of the specified mail object profile. Sender Address: Enter the e-mail address (e.g., johnwash@abc.com.tw).
<i>INDEX -t Authentication</i>	The mail server must be authenticated with the correct username and password to have the right of sending message out. INDEX: Enter the index number (from 1 to 10) of the specified mail object profile. Authentication: Enter 0 or 1. 0 - disable 1 - enable to use the port number.
<i>INDEX -u Username</i>	Type a name for authentication. The maximum length of the name you can set is 31 characters. INDEX: Enter the index number (from 1 to 10) of the specified mail object profile. Username: Enter a string as a username.
<i>INDEX -p Password</i>	Type a password for authentication. The maximum length of the password you can set is 31 characters. INDEX: Enter the index number (from 1 to 10) of the specified mail object profile. Password: Enter a password.
<i>INDEX -i Sending Interval</i>	Define the interval for the system to send the SMS out. The unit is second. INDEX: Enter the index number (from 1 to 10) of the specified mail object profile. Sending Interval: Enter a value (seconds).

Example

```

> object mail obj 1 -n buyer
> object mail obj 1 -s 192.168.1.98
> object mail obj 1 -m 25
> object mail obj 1 -t 1
> object mail obj 1 -u john
> object mail obj 1 -p happy123456
> object mail obj 1 -i 25
> object mail obj 1 -v
Profile Index: 1
Profile Name:[buyer]
SMTP Server:[192.168.1.98]
SMTP Port:[25]
Sender Address:[]
Use SSL:[disable]
Authentication:[enable]
Username:[john]
Password:[*****]
Sending Interval:[25(seconds)]
>

```

Telnet Command: object noti

This command is used to create notification object profile.

Syntax

`object noti show`

`object noti setdefault`

`object noti obj INDEX -v`

`object noti obj INDEX -n Profile Name`

`object mail obj INDEX -e Category Status`

`object mail obj INDEX -d Category Status`

Syntax Description

Parameter	Description
<i>show</i>	It means to show the contents for all of the profiles.
<i>setdefault</i>	It means to return to default settings for all profiles.
<i>INDEX -v</i>	It means to view the information of the specified notification object profile. INDEX: Enter the index number (from 1 to 8) of the specified notification object profile.
<i>INDEX -n Profile Name</i>	It means to define a name for the notification object profile. INDEX: Enter the index number (from 1 to 8) of the specified notification object profile. Profile Name: Type a name with less than 15 characters.
<i>INDEX-e Category Status</i>	It means to enable the status of specified category. INDEX: Enter the index number (from 1 to 8) of the specified notification object profile. Category: Enter 1, 2, 3, 4 or 5. 1: WAN; 2: VPN Tunnel; 3: Temperature Alert; 4: WAN Budget; 5: CVM Status: Enter 1, 2, 3, 4, or 5 For WAN - 1: Disconnected; 2: Reconnected. For VPN Tunnel - 1: Disconnected; 2: Reconnected. For Temperature Alert -

	1: Out of Range. For WAN Budget 1: Limit Reached. For CVM 1: CPE Offline; 2: Backup Fail; 3: Restore Fail; 4: FW Update Fail; 5: VPN Profile Setup Fail.
<i>INDEX -d Category Status</i>	It means to disable the status of specified category. INDEX: Enter the index number (from 1 to 8) of the specified notification object profile. Category: Enter 1, 2, 3, 4 or 5. 1: WAN; 2: VPN Tunnel; 3: Temperature Alert; Status: Enter 1, 2 For WAN - 1: Disconnected; 2: Reconnected. For VPN Tunnel - 1: Disconnected; 2: Reconnected. For Temperature Alert - 1: Out of Range.

Example

```

> object noti obj 1 -n marketing
> object noti obj 1 -e 1 1
> object noti obj 1 -e 2 1
> object noti obj 1 -e 5 3
> object noti obj 1 -v
DrayTek> object noti obj 1 -v
Profile Index: 1
Profile Name:[marketing]
      Category                Status
WAN                [v]Disconnected    [ ]Reconnected
VPN Tunnel          [v]Disconnected    [ ]Reconnected
Temperature Alert  [v]Out of Range

```

Telnet Command: object schedule

This command is used to create schedule object profile.

Syntax

object schedule set <INDEX> <option list>

object schedule view <INDEX>

object schedule setdefault

Syntax Description

Parameter	Description
<i>set</i>	It means to set the schedule profile.
<INDEX>	It means the index number (from 1 to 15) of the specified object profile.
<option list>	Available options for schedule includes: -e , -c, -D, -T, -d, -a, -i, -h
<INDEX> -e <value>	It means to enable the schedule setup. <INDEX>: Enter the index number (from 1 to 15) of the specified schedule object. <value>: Enter 0 or 1. 0, disable 1, enable
<INDEX> -c <comment>	It means to set brief description for the specified profile. <INDEX>: Enter the index number (from 1 to 15) of the

	specified schedule object. <comment>: Enter a brief description (1 ~ 32 characters).
<INDEX> -D <year> <month> <day>	It means to set the starting date of the profile. <INDEX>: Enter the index number (from 1 to 15) of the specified schedule object. <year> - Must be between 2000-2049. <month>- Must be between 1-12. <day> - Must be between 1-31. For example: To set Start Date 2015/10/6, type > <i>object schedule set 1 -D "2015 10 6"</i>
<INDEX> -T <hour> <minute>	It means to set the starting time of the profile. <INDEX>: Enter the index number (from 1 to 15) of the specified schedule object. <hour>: Must be between 0-23. <minute>: Must be between 0-59. For example: To set Start Time 10:20, type > <i>object schedule set 1 -T "10 20"</i>
<INDEX> -d <hour> <minute>	It means to set the duration time of the profile. <INDEX>: Enter the index number (from 1 to 15) of the specified schedule object. <hour>: Must be between 0-23. <minute>: Must be between 0-59. For example: To set Duration Time 3:30, type > <i>object schedule set 1 -d "3 30"</i>
<INDEX> -a <value>	It means to set the action used for the profile. <INDEX>: Enter the index number (from 1 to 15) of the specified schedule object. <value>: Enter 0, 1, 2, or 3 0:Force On, 1:Force Down, 2:Enable Dial-On-Demand, 3:Disable Dial-On-Demand
<INDEX> -l <value>	It means to set idle time. <INDEX>: Enter the index number (from 1 to 15) of the specified schedule object. <value>: Must be between 0-255(minute). The default is 0.
<INDEX> -h <option> <day/date/cycle_days>	Set how often the schedule will be applied. <INDEX>: Enter the index number (from 1 to 15) of the specified schedule object. <option>: Enter 0, 1, 2 or 3 0: Once, 1: Weekdays, 2:Monthly, 3:Cycle days <day>: Enter Sun, Mon, Tue, Wed, Thu, Fri, Sat If the <option> set Weekdays, then must select which days of Week. example: To select Sunday, Monday, Thursday, type <date>: Enter 1-28. <cycle_days> : Enter 1-30. If the <option> set cycle days, then must select which days to do cycle schedule example: To select cycle 10 days: > <i>object schedule set 1 -h 3 10"</i>
view <INDEX>	It means to show the content of the profile. <INDEX>: Enter the index number (from 1 to 15) of the specified schedule object.
setdefault	It means to return to default settings for all profiles.

Example

```

> object schedule set 1 -e 1
> object schedule set 1 -c Working
> object schedule set 1 -D "2017 4 18"
> object schedule set 1 -T "8 1"
> object schedule set 1 -d "2 30"

```

```

> object schedule set 1 -a 0
> object schedule set 1 -h "1 Mon Wed"
> object schedule view 1
Index No.1

-----

[v] Enable Schedule Setup
  Comment [ Working ]
  Start Date (yyyy-mm-dd) [ 2017 ]-[ 4 ]-[ 18 ]
  Start Time (hh:mm)      [ 8 ]:[ 1 ]
  Duration Time (hh:mm)   [ 2 ]:[ 30 ]
  Action                  [ Force On ]
  Idle Timeout            [ 0 ] minute(s).(max. 255, 0 for default)

-----

How Often
  [v] Weekdays
      [ ]Sun [v]Mon [ ]Tue [v]Wed [ ]Thu [ ]Fri [ ]Sat
>

```

Telnet Command: port

This command allows users to set the speed for specific port of the router.

Syntax

port <1, 2, all> <AN, 100F, 100H, 10F, 10H, status>

port <wan2> <AN, 1000F, 100F, 100H, 10F, 10H, status>

port status

port wanfc

Syntax Description

Parameter	Description
<1, 2, all> <AN, 100F, 100H, 10F, 10H, status>	<p><1, 2, all> : Enter 1, 2 or all to specify the number of LAN port.</p> <p><AN, 100F, 100H, 10F, 10H, status>: It means the physical type for the specific port.</p> <p>AN: auto-negotiate.</p> <p>100F: 100M Full Duplex.</p> <p>100H: 100M Half Duplex.</p> <p>10F: 10M Full Duplex.</p> <p>10H: 10M Half Duplex.</p>
<wan2> <AN, 1000F, 100F, 100H, 10F, 10H, status>	<p>It means the WAN2 interface.</p> <p><AN, 1000F, 100F, 100H, 10F, 10H, status>: It means the physical type for the specific port.</p> <p>AN: auto-negotiate.</p> <p>1000F: 1000M Full Duplex.</p> <p>100F: 100M Full Duplex.</p> <p>100H: 100M Half Duplex.</p> <p>10F: 10M Full Duplex.</p> <p>10H: 10M Half Duplex.</p>

<i>status</i>	It means to view the Ethernet port status.
<i>wanfc</i>	It means to set WAN flow control.

Example

```
> port 1 100F
%Set Port 1 Force speed 100 Full duplex OK !!!
```

Telnet Command: portmuptime

This command allows you to set a time of keeping the session connection for specified protocol.

Syntax

portmuptime *-<command>* *<parameter>* / ...

Syntax Description

Parameter	Description
<i><command></i> <i><parameter>/...</i>	The available commands with parameters are listed below. <...> means that you can Enter several commands in one line.
<i>-t <sec></i>	It means "TCP" protocol. <sec>: Type a number to set the TCP session timeout.
<i>-u <sec></i>	It means "UDP" protocol. <sec>: Type a number to set the UDP session timeout.
<i>-i <sec></i>	It means "IGMP" protocol. <sec>: Type a number to set the IGMP session timeout.
<i>-w <sec></i>	It means "TCP WWW" protocol. <sec>: Type a number to set the TCP WWW session timeout.
<i>-s <sec></i>	It means "TCP SYN" protocol. <sec>: Type a number to set the TCP SYN session timeout.
<i>-f</i>	It means to flush all portmaps (useful for diagnostics).
<i>-l <List></i>	List all settings.

Example

```
> portmuptime -t 86400 -u 300 -i 10
> portmuptime -l
----- Current setting -----
TCP Timeout      : 86400 sec.
UDP Timeout      : 300 sec.
IGMP Timeout     : 10 sec.
TCP WWW Timeout  : 60 sec.
TCP SYN Timeout  : 60 sec.
```

Telnet Command: qos setup

This command allows user to set general settings for QoS.

Syntax

qos setup *-<command>* *<parameter>* / ...

Syntax Description

Parameter	Description
<i><command></i>	The available commands with parameters are listed below.

<i><parameter>/...</i>	<i><...></i> means that you can Enter several commands in one line.
<i>-h</i>	Enter it to display the usage of this command.
<i>-W <1-3></i>	It means to specify WAN interface. <i><1-3></i> : Enter 1, 2, 3. Default is 1 (WAN1).
<i>-m <mode></i>	It means to define which traffic the QoS control settings will apply to and enable QoS control. <i><mode></i> : Enter 0, 1, 2, or 3. Default is 2. 0: disable. 1: in, apply to incoming traffic only. 2: out, apply to outgoing traffic only. 3: both, apply to both incoming and outgoing traffic.
<i>-i <bandwidth></i>	It means to set inbound bandwidth in kbps (Ethernet WAN only) <i><bandwidth></i> : Enter the value (1 to 100000).
<i>-o <bandwidth></i>	It means to set outbound bandwidth in kbps (Ethernet WAN only). <i><bandwidth></i> : Enter the value (1 to 100000).
<i>-r <index:ratio></i>	It means to set ratio for class index, in %. <i><index:ratio></i> : Enter a value with ratio (e.g., -r 3:20).
<i>-u <mode></i>	It means to enable bandwidth control for UDP. <i><mode></i> : Enter 0 or 1. Default is disable. 0: disable 1: enable
<i>-p <ratio></i>	It means to enable bandwidth limit ratio for UDP. <i><ratio></i> : Enter the value.
<i>-t <mode></i>	It means to enable/disable Outbound TCP ACK Prioritize. <i><mode></i> : Enter 0 or 1. Default is disable. 0: disable 1: enable
<i>-V</i>	Show all the settings.
<i>-D</i>	Set all to factory default (for all WANs).
<i>[...]</i>	It means that you can Enter several commands in one line.

Example

```
> qos setup -m 3 -i 9500 -o 8500 -r 3:20 -u 1 -p 50 -t 1

WAN1 QoS mode is both
Wan 1 is XDSL model ,don,t need to set up
Wan 1 is XDSL model ,don,t need to set up
WAN1 class 3 ratio set to 20
WAN1 udp bandwidth control set to enable
WAN1 udp bandwidth limit ratio set to 50
WAN1 Outbound TCP ACK Prioritizel set to enable
QoS WAN1 set complete; restart QoS
>
```

Telnet Command: qos class

This command allows user to set QoS class.

Syntax

```
qos class -c <no> -<a/e/d <no>><-<command> <parameter> / ... >
```

Syntax Description

Parameter	Description
-----------	-------------

<i><command></i> <i><parameter>/...</i>	The available commands with parameters are listed below. <...> means that you can Enter several commands in one line.
<i>-h</i>	Type it to display the usage of this command.
<i>-c <no></i>	Specify the inde number for the class. <no>: Enter 1, 2 or 3. The default setting is class 1.
<i>-n <name></i>	It means to type a name for the class. <name>: Enter a name.
<i>-a <no></i>	It means to add rule for specified class. <no>: Enter the index number for the rule.
<i>-e <no></i>	It means to edit specified rule. <no>: Enter the index number for the rule.
<i>-d <no></i>	It means to delete specified rule. <no>: Enter the index number for the rule.
<i>-m <mode></i>	It means to enable or disable the specified rule. <mode>: Enter 0 or 1. 0: disable, 1: enable
<i>-l <addr></i>	Set the local address. <addr>: Enter <Addr1>, <addr1:addr2>, <addr1:subnet> or any. <Addr1> - It means Single address. Please specify the IP address directly, for example, "-l 172.16.3.9". <addr1:addr2> - It means Range address. Please specify the IP addresses, for example, "-l 172.16.3.9: 172.16.3.50." <addr1:subnet> - It means the subnet address with start IP address. Please Enter the subnet and the IP address, for example, "-l 172.16.3.9:255.255.0.0".0 <any> - It means Any address. Simple type "-/" to specify any address for this command.
<i>-r <addr></i>	Set the remote address. <addr>: Enter <Addr1>, <addr1:addr2>, <addr1:subnet> or any. <Addr1> - It means Single address. Please specify the IP address directly, for example, "-l 172.16.3.9". <addr1:addr2> - It means Range address. Please specify the IP addresses, for example, "-l 172.16.3.9: 172.16.3.50." <addr1:subnet> - It means the subnet address with start IP address. Please Enter the subnet and the IP address, for example, "-l 172.16.3.9:255.255.0.0".0 <any> - It means Any address. Simple type "-/" to specify any address for this command.
<i>-p <DSCP id></i>	Specify the ID. <DSCP id>: Enter the ID.
<i>-s <Service type></i>	Specify the service type by typing the number. <Service type>: Enter 1, 2, 3, 4, 5, 6, 7, 8, 9, 10, 11, 12, 13, 14, 15, 16, 17, 18, 19, 20, 21, 22, 23, 24, 25, 26, 27, 28, 29 or 30. 1:ANY 2:DNS 3:FTP 4:GRE 5:H.323 6:HTTP 7:HTTPS 8:IKE 9:IPSEC-AH 10:IPSEC-ESP 11:IRC 12:L2TP 13:NEWS 14:NFS 15:NNTP 16:PING 17:POP3 18:PPTP 19:REAL-AUDIO 20:RTSP 21:SFTP 22:SIP 23:SMTP 24:SNMP 25:SNMP-TRAPS 26:SQL-NET 27:SSH 28:SYSLOG 29:TELNET 30:TFTP
<i>-S <d/s></i>	Show the content for specified DSCP ID/Service type. <d/s>: Enter d or s.
<i>-V <1/2/3></i>	Show the rule in the specified class. <1/2/3>: Enter 1, 2 or 3.
<i>[...]</i>	It means that you can Enter several commands in one line.

Example

```
> qos class -c 2 -n draytek -a -m 1 -l 192.168.1.50:192.168.1.80
```

```
Following setting will set in the class2
class 2 name set to draytek
Add a rule in class2
Class2 the 1 rule enabled
Set local address type to Range, 192.168.1.50:192.168.1.80
```

Telnet Command: qos type

This command allows user to configure protocol type and port number for QoS.

Syntax

```
qos type -a <service name> / -e <no> / -d <no> / -n <name> / -t <type> / -p <port> / -l
```

Syntax Description

Parameter	Description
-a <service name>	It means to add rule. <name>: Enter a name for a rule.
-e <no>	It means to edit user defined service type. <no>: Enter 1 ~ 40 (index number of the service type).
-d <no>	It means to delete user defined service type. <no>: Enter 1 ~ 40 (index number of the service type).
-n <name>	It means the name of the service. <name>: Enter a name of the service.
-t <type>	<type>: It means protocol type. Enter 6, 17, 0 or other number. 6: tcp(default) 17: udp 0: tcp/udp <1-254>: other
-p <port>	It means service port. <port>: Enter the port number. The typing format must be [start:end] (ex., 510:330).
-l	List user defined types. "no" means the index number. Available numbers are 1-40.

Example

```
> qos type -a draytek -t 6 -p 510:1330

service name set to draytek
service type set to 6:TCP
Port type set to Range
Service Port set to 510 ~ 1330
>
```

Telnet Command: qos setdefault

This command allows user to recover the default settings for QoS.

Syntax

```
qos setdefault
```

Example

```
> qos setdefault
Setdefault!
>
```

Telnet Command: quit

This command can exit the telnet command screen.

Telnet Command: show lan

This command displays current status of LAN IP address settings.

Example

```
> show lan

The LAN settings:
Status  IP            Mask            DHCP Start IP      Pool Gateway
-----
[V]LAN1 192.168.1.1    255.255.255.0   V   192.168.1.10      200 192.168.1.1
[X]LAN2 192.168.5.1    255.255.255.0   V   192.168.2.10      100 192.168.2.1
[X]Route 192.168.0.1    255.255.255.0   V   0.0.0.0           0   192.168.0.1
```

Telnet Command: show dmz

This command displays current status of DMZ host.

Example

```
> show dmz

%      WAN1 DMZ mapping status:
Index  Status  WAN1 aux IP    Private IP
-----
1      Disable 0.0.0.0

%      WAN2 DMZ mapping status:
Index  Status  WAN2 aux IP    Private IP
-----
1      Disable 0.0.0.0

%      WAN3 DMZ mapping status:
Index  Status  WAN3 aux IP    Private IP
-----
1      Disable 0.0.0.0
```

Telnet Command: show dns

This command displays current status of DNS setting.

Example

```
> show dns
%%      Domain name server settings:
% LAN1  Primary DNS: [Not set]
% LAN1  Secondary DNS: [Not set]

% LAN2  Primary DNS: [Not set]
% LAN2  Secondary DNS: [Not set]
```

Telnet Command: show openport

This command displays current status of open port setting.

Example

```
> show openport
Index  Status  Comment          Local IP Address
*****
  1.   Enable TEST          192.168.1.110
Total 1 items listed.
```

Telnet Command: show nat

This command displays current status of NAT.

Example

```
> show nat
Port Redirection Running Table:

Index Protocol Public Port      Private IP      Private Port
1       0           0          0.0.0.0         0
2       0           0          0.0.0.0         0
3       0           0          0.0.0.0         0
4       0           0          0.0.0.0         0
5       0           0          0.0.0.0         0
6       0           0          0.0.0.0         0
7       0           0          0.0.0.0         0
8       0           0          0.0.0.0         0
9       0           0          0.0.0.0         0
10      0           0          0.0.0.0         0
11      0           0          0.0.0.0         0
12      0           0          0.0.0.0         0
13      0           0          0.0.0.0         0
14      0           0          0.0.0.0         0
15      0           0          0.0.0.0         0
16      0           0          0.0.0.0         0
17      0           0          0.0.0.0         0
18      0           0          0.0.0.0         0
19      0           0          0.0.0.0         0
20      0           0          0.0.0.0         0
--- MORE --- ['q': Quit, 'Enter': New Lines, 'Space Bar': Next Page]
```

Telnet Command: show portmap

This command displays the table of NAT Active Sessions.

Example

```
> show portmap
-----
Private_IP:Port Pseudo_IP:Port Peer_IP:Port [Index/Protocol/Flag]
-----

Total Portmap Session:0
```

Telnet Command: show pmtime

This command displays the reuse time of NAT session.

Level0: It is the default setting.

Level1: It will be applied when the NAT sessions are smaller than 25% of the default setting.

Level2: It will be applied when the NAT sessions are smaller than the eighth of the default setting.

Example

```
> show pmtime
Level0 TCP=86400001 UDP=300001 ICMP=10001
Level1 TCP=600000 UDP=90000 ICMP=7000
```

```
Level2 TCP=60000 UDP=30000 ICMP=5000
```

Telnet Command: show session

This command displays current status of current session.

Example

```
> show session
% Maximum Session Number: 30000
% Maximum Session Usage: 0
% Current Session Usage: 0
% Current Session Used(include waiting for free): 0
% WAN1 Current Session Usage: 0
% WAN2 Current Session Usage: 0
% WAN3 Current Session Usage: 0
```

Telnet Command: show status

This command displays current status of LAN and WAN connections.

Example

```
> show status
System Uptime:25:40:53
LAN Status
Primary DNS:8.8.8.8      Secondary DNS:8.8.4.4
IP Address:192.168.1.1   Tx Rate:21417   Rx Rate:15413

WAN 1 Status: Disconnected
Enable:Yes      Line:Fiber      Name:
Mode:PPPoE      Up Time:0:00:00   IP:---      GW IP:---
TX Packets:0      TX Rate(bps):0   RX Packets:0      RX Rate(bps):0

WAN 2 Status: Disconnected
Enable:Yes      Line:Ethernet     Name:
Mode:DHCP Client Up Time:0:00:00   IP:---      GW IP:---
TX Packets:0      TX Rate(bps):0   RX Packets:0      RX Rate(bps):0
```

Telnet Command: show adsl

This command displays current status of ADSL.

Example

```
> show status
----- ATU-R Info (hw: annex A, f/w: annex A/B/C) -----
Running Mode      :          State      : TRAINING
DS Actual Rate    : 0 bps      US Actual Rate    : 0 bps
DS Attainable Rate : 0 bps      US Attainable Rate : 0 bps
DS Path Mode      : Fast        US Path Mode      : Fast
DS Interleave Depth : 0          US Interleave Depth : 0
NE Current Attenuation : 0 dB      Cur SNR Margin    : 0 dB
DS actual PSD     : 0.0 dB      US actual PSD     : 0.0 dB
NE CRC Count      : 0          FE CRC Count      : 0
NE ES Count       : 0          FE ES Count       : 0
Xdsl Reset Times  : 0          Xdsl Link Times   : 0
```

```
ITU Version[0]      : b5004946   ITU Version[1]      : 544e0000
VDSL Firmware Version : 05-07-06-0D-01-07 [with Vectoring support]
Power Management Mode : DSL_G997_PMS_NA
Test Mode           : DISABLE
----- ATU-C Info -----
Far Current Attenuation :      0 dB   Far SNR Margin      :      0 dB
CO ITU Version[0]      : 00000000   CO ITU Version[1]    : 00000000
DSLAM CHIPSET VENDOR   : < ----- >
>
```

Telnet Command: `srv dhcp dhcp2`

This command is used to enable DHCP2 server.

Syntax

`srv dhcp dhcp2 -<command> <parameter> / ...`

Syntax Description

Parameter	Description
<code><command></code> <code><parameter>/...</code>	The available commands with parameters are listed below. [...] means that you can Enter several commands in one line.
<code>-l <enable></code>	It means to enable the LAN port to public DHCP. <enable>: Enter 0 or 1. 0: Disable 1: Enable
<code>-m<enable></code>	It means to enable MAC address to public DHCP. <enable>: Enter 0 or 1. 0: Disable 1: Enable
<code>-e <id></code>	It means to turn on the flag of LAN port 1/2. <id>: Enter 1 or 2.
<code>-d <id></code>	It means to turn off the flag of LAN port 1/2. <id>: Enter 1 or 2.
<code>-v</code>	It means to view current status.

Example

```
> srv dhcp dhcp2 -l 1 -e 1
> srv dhcp dhcp2 -v
2nd DHCP server flag status --
  Server works on specified MAC address: ON
  Server works on specified LAN port: ON
  Port 1 flag: ON
  Port 2 flag: ON
```

Telnet Command: `srv dhcp public`

This command allows users to configure DHCP server for second subnet.

Syntax

`srv dhcp public start <IP address>`

`srv dhcp public cnt <IP counts>`

`srv dhcp public status`

`srv dhcp public add <MAC Addr XX-XX-XX-XX-XX-XX>`

`srv dhcp public del <MAC Addr XX-XX-XX-XX-XX-XX >`

`srv dhcp public del all/ALL`

Syntax Description

Parameter	Description
<code>start <IP address></code>	It means the starting point of the IP address pool for the DHCP server. <IP address>: Enter an IP address as the starting point in the IP address pool.
<code>cnt <IP counts></code>	It means the IP count number. <IP counts>: Specify the number of IP addresses in the pool.

	The maximum is 10.
<i>status</i>	It means the execution result of this command.
<i>add</i> <MAC Addr XX-XX-XX-XX-XX-XX>	It means creating a list of hosts to be assigned. <MAC Addr>: Enter the MAC Address of the host.
<i>del</i> <MAC Addr XX-XX-XX-XX-XX-XX>	It means removing the selected MAC address. <MAC Addr>: Enter the MAC Address of the host.
<i>del all/ALL</i>	It means removing all of the MAC addresses.

Example

```
> ip route add 192.168.1.56 255.255.255.0 192.168.1.12 3 default
> srv dhcp public status
Index   MAC Address
```

Telnet Command: *srv dhcp dns1*

This command allows users to set Primary IP Address for DNS Server in LAN.

Syntax

srv dhcp dns1 <LAN1/LAN2> <DNS IP address>

Syntax Description

Parameter	Description
<LAN1/LAN2>	It means to specify the LAN interface. <LAN1/LAN2>: Enter LAN1 or LAN2.
<DNS IP address>	It means the IP address that you want to use as DNS1. <DNS IP address>: Enter the IP address that you want to use as DNS1 (primary DNS). Note: The IP Routed Subnet DNS must be the same as NAT Subnet DNS).

Example

```
> srv dhcp dns1 lan1 168.95.1.1
% srv dhcp dns1 lan1 <DNS IP address>
% Now: 168.95.1.1
```

Telnet Command: `srv dhcp dns2`

This command allows users to set Secondary IP Address for DNS Server in LAN.

Syntax

`srv dhcp dns2 <LAN1/LAN2> <DNS IP address>`

Syntax Description

Parameter	Description
<code><LAN1/LAN2></code>	It means to specify the LAN interface.
<code><DNS IP address></code>	It means the IP address that you want to use as DNS2. <DNS IP address>: Enter the IP address that you want to use as DNS1 (seconday DNS). Note: The IP Routed Subnet DNS must be the same as NAT Subnet DNS.

Example

```
> srv dhcp dns2 lan1 168.95.1.1
% srv dhcp dns2 lan1 <DNS IP address>
% Now: 168.95.1.1
```

Telnet Command: `srv dhcp frcdnsman1`

This command can force the router to invoke DNS Server IP address.

Syntax

`srv dhcp frcdnsman1 <on /off>`

Syntax Description

Parameter	Description
<code>on</code>	It means to use manual setting for DNS setting.
<code>Off</code>	It means to use auto settings acquired from ISP.

Example

```
> srv dhcp frcdnsman1 on
% Domain name server now is using manual settings!
> srv dhcp frcdnsman1 off
% Domain name server now is using auto settings!
```

Telnet Command: `srv dhcp gateway`

This command allows users to specify gateway address for DHCP server.

Syntax

```
srv dhcp gateway <Gateway IP>
```

Syntax Description

Parameter	Description
<Gateway IP>	It means to specify a gateway address used for DHCP server. <gateway IP>: Enter an IP address.

Example

```
> srv dhcp gateway 192.168.2.1
This setting will take effect after rebooting.
Please use "sys reboot" command to reboot the router.
```

Telnet Command: `srv dhcp ipcnt`

This command allows users to specify IP counts for DHCP server.

Syntax

```
srv dhcp ipcnt <IP counts>
```

Syntax Description

Parameter	Description
<IP counts>	It means the number that you have to specify for the DHCP server. <IP counts>: Enter a value (0-256).

Example

```
> srv dhcp ipcnt ?
% srv dhcp ipcnt <IP counts>
% Now: 150
```

Telnet Command: `srv dhcp off`

This function allows users to turn off DHCP server. It needs rebooting router, please type "sys reboot" command to reboot router.

Telnet Command: `srv dhcp on`

This function allows users to turn on DHCP server. It needs rebooting router, please type "sys reboot" command to reboot router.

Telnet Command: `srv dhcp relay`

This command allows users to set DHCP relay setting.

Syntax

```
srv dhcp relay servip <server ip>
```

```
srv dhcp relay subnet <index>
```

Syntax Description

Parameter	Description
<i><server ip></i>	It means the IP address that you want to used as DHCP server. <server ip>: Enter an IP address.
<i><Index></i>	The router will invoke this function according to the subnet 1 or 2 specified here. <index>: Enter 1 or 2.

Example

```
> srv dhcp relay servip 192.168.1.46
> srv dhcp relay subnet 2
> srv dhcp relay servip ?
% srv dhcp relay servip <server ip>
% Now: 192.168.1.46
```

Telnet Command: srv dhcp startip

Syntax

srv dhcp startip *<IP address>*

Syntax Description

Parameter	Description
<i><IP address></i>	It means the IP address that you can specify for the DHCP server as the starting point. <IP address>: Enter an IP address.

Example

```
> srv dhcp startip 192.168.1.53
This setting will take effect after rebooting.
Please use "sys reboot" command to reboot the router.
```

Telnet Command: srv dhcp status

This command can display general information for the DHCP server, such as IP address, MAC address, leased time, host ID and so on.

Example

```
> srv dhcp status
LAN1      : DHCP Server On   IP Pool: 192.168.1.10 ~ 192.168.1.209
           Default Gateway: 192.168.1.1
-----
Index  IP Address      MAC Address          Leased Time      HOST ID
-----
LAN1
```

Telnet Command: `srv dhcp leasetime`

This command can set the lease time for the DHCP server.

Syntax

`srv dhcp leasetime <Lease Time (sec)>`

Syntax Description

Parameter	Description
<code><Lease Time (sec)></code>	It means the lease time that DHCP server can use. The unit is second. <code><Lease Time (sec)></code> : Enter a value.

Example

```
> srv dhcp leasetime ?
% srv dhcp leasetime <Lease Time (sec.)>
% Now: 92000
>
```

Telnet Command: `srv dhcp nodetype`

This command can set the node type for the DHCP server.

Syntax

`srv dhcp nodetype <count>`

Syntax Description

Parameter	Description
<code><count></code>	It means to specify a type for node. <code><count></code> : Enter 1, 2, 4 or 8. 1. B-node 2. P-node 4. M-node 8. H-node

Example

```
> srv dhcp nodetype 1
> srv dhcp nodetype ?
%% srv dhcp nodetype <count>
%% 1. B-node 2. P-node 4. M-node 8. H-node
% Now: 1
```

Telnet Command: `srv dhcp primWINS`

This command can set the primary IP address for the DHCP server.

Syntax

```
srv dhcp primWINS <WINS IP address>
```

```
srv dhcp primWINS clear
```

Syntax Description

Parameter	Description
<code><WINS IP address></code>	It means the IP address of primary WINS server. <code><WINS IP address></code> : Enter an IP address.
<code>clear</code>	It means to remove the IP address settings of primary WINS server.

Example

```
> srv dhcp primWINS 192.168.1.88
> srv dhcp primWINS ?
%% srv dhcp primWINS <WINS IP address>
%% srv dhcp primWINS clear
% Now: 192.168.1.88
```

Telnet Command: `srv dhcp secWINS`

This command can set the secondary IP address for the DHCP server.

Syntax

```
srv dhcp secWINS <WINS IP address>
```

```
srv dhcp secWINS clear
```

Syntax Description

Parameter	Description
<code><WINS IP address></code>	It means the IP address of secondary WINS server. <code><WINS IP address></code> : Enter an IP address.
<code>clear</code>	It means to remove the IP address settings of second WINS server.

Example

```
> srv dhcp secWINS 192.168.1.180
> srv dhcp secWINS ?
%% srv dhcp secWINS <WINS IP address>
%% srv dhcp secWINS clear
% Now: 192.168.1.180
```

Telnet Command: `srv dhcp expRecycleIP`

This command can set the time to check if the IP address can be assigned again by DHCP server or not.

Syntax

`srv dhcp expRecycleIP <sec time>`

Syntax Description

Parameter	Description
<code><sec time></code>	It means to set the time (5-300 seconds) for checking if the IP can be assigned again or not. <code><sec time></code> : Enter a value.

Example

```
> srv dhcp expRecycleIP 250
% DHCP expRecycleIP = 250
```

Telnet Command: `srv dhcp tftp`

This command can set the TFTP server as the DHCP server.

Syntax

`srv dhcp tftp <TFTP server name>`

Syntax Description

Parameter	Description
<code><TFTP server name></code>	It means to Enter the name of TFTP server. <code><TFTP server name></code> : Enter a name.

Example

```
> srv dhcp tftp TF123
> srv dhcp tftp ?
%% srv dhcp tftp <TFTP server name>
% Now: TF123
```

Telnet Command: `srv dhcp tftpdel`

This command can remove the name defined for the TFTP server.

Syntax

`srv dhcp tftpdel`

Example

```
> srv dhcp tftp TF123
> srv dhcp tftp ?
%% srv dhcp tftp <TFTP server name>
% Now: TF123
> srv dhcp tftpdel
% The TFTP Server Name had been deleted !!!
```

Telnet Command: `srv nat dmz`

This command allows users to set DMZ host. Before using this command, please set WAN IP Alias first.

Syntax

```
srv nat dmz n m -e <1/0> -i <IP address>
```

```
srv nat dmz -r
```

```
srv nat dmz -v
```

Syntax Description

Parameter	Description
<i>n</i>	It means to map selected WAN IP to certain host. 1: wan1
<i>m</i>	It means the index number of the DMZ host. m: Enter 1 ~ 8. Default setting is "1" (WAN 1). It is only available for Static IP mode. If you use other mode, you can set in this field. If WAN IP alias has been configured, then the number of DMZ host can be added more.
<i>-e <1/0></i>	It means to enable/disable such feature. <1/0>: Enter 1 or 0. 1:enable 0:disable
<i>-i <IP address></i>	It means to specify the private IP address of the DMZ host. <IP address>: Enter an IP address.
<i>-r</i>	It means to remove DMZ host setting.
<i>-v</i>	It means to display current status.

Example

```
> srv nat dmz 1 1 -i 192.168.1.96 -e 1
> srv nat dmz -v
%      WAN1 DMZ mapping status:
Index  Status  WAN1 aux IP    Private IP
-----
  1    Enable  0.0.0.0 192.168.1.96

%      WAN2 DMZ mapping status:
Index  Status  WAN2 aux IP    Private IP
-----
  1    Disable  0.0.0.0

%      WAN3 DMZ mapping status:
Index  Status  WAN3 aux IP    Private IP
-----
  1    Disable  0.0.0.0
```

Telnet Command: `srv nat ipsecpass`

This command allows users to enable or disable IPSec ESP tunnel passthrough and IKE source port (500) preservation.

Syntax

`srv nat ipsecpass on`

`srv nat ipsecpass off`

`srv nat ipsecpass status`

Syntax Description

Parameter	Description
<i>[options]</i>	The available commands with parameters are listed below.
<i>on</i>	It means to enable IPSec ESP tunnel passthrough and IKE source port (500) preservation.
<i>off</i>	It means to disable IPSec ESP tunnel passthrough and IKE source port (500) preservation.
<i>status</i>	It means to display current status for checking.

Example

```
> srv nat ipsecpass status
%% Status: IPsec ESP pass-thru and IKE src_port:500 preservation is OFF.
```

Telnet Command: `srv nat openport`

This command allows users to set open port settings for NAT server.

Syntax

`srv nat openport n m -<command> <parameter> / ...`

Syntax Description

Parameter	Description
<i>n</i>	It means the index number for the profiles. N: Enter 1 ~20.
<i>m</i>	It means to specify the sub-item number for this profile. m: Enter 1 ~10.
<i>[<command> <parameter>/...]</i>	The available commands with parameters are listed below. [...] means that you can Enter several commands in one line.
<i>-a <enable></i>	It means to enable or disable the open port rule profile. <enable>: Enter 1 or 0. 0: disable 1: enable
<i>-c <comment></i>	It means to Enter the description (less than 23 characters) for the defined network service. <comment>: Enter a description.
<i>-i <local ip></i>	It means to set the IP address for local computer. <local ip>: Enter an IP address.

<code>-w <widx> <ipidx></code>	It means to specify the public IP. <code><widx></code> - Enter 1, 2, 255 (means the WAN interface) 1: WAN1 (Default) 2: WAN1 Alias 1 255: all WANs. <code><ipidx></code> - Enter 1 ~ 32 for Alias IPs.
<code>-p <protocol></code>	Specify the transport layer protocol. <code><protocol></code> : Enter TCP, UDP, or ALL.
<code>-s <start port></code>	It means to specify the starting port number of the service offered by the local host. <code><start port></code> : Enter a value (0 to 65535).
<code>-e <end port></code>	It means to specify the ending port number of the service offered by the local host. <code><end port></code> : Enter a value (0 to 65535).
<code>-v</code>	It means to display current settings.
<code>-r</code>	It means to delete the specified open port setting.
<code>-f</code>	It means to return to factory settings for all the open ports profiles.

Example

```

> srv nat openport 1 1 -a 1 -c games -i 192.168.1.56 -w 1 1 -p TCP -s 23 -e
83
> Set WAN Port ok!!
> srv nat openport 1 1 -v
%% Status: Enable
%% Comment: games
%% WAN Interface: WAN1
%% Private IP address: 192.168.1.56
Index  Protocal      Start Port    End Port
*****
  1.    TCP         23            83

> srv nat openport 1 1 -r
> srv nat openport 1 1 -f
>

```

Telnet Command: `srv nat portmap`

This command allows users to set port redirection table for NAT server.

Syntax

`srv nat portmap add <idx> <serv name> <proto> <pub port> <src ip idx> <pri ip> <pri port> <wan1 ~ wan4> <alias IP>`

`srv nat portmap del <idx>`

`srv nat portmap disable <idx>`

`srv nat portmap enable <idx> <proto>`

`srv nat portmap flush`

`srv nat portmap table`

Syntax Description

Parameter	Description
<i>add</i> <idx> <serv name> <proto> <pub port> <src ip idx> <pri ip> <pri port> <wan1 ~ wan4> <alias IP>	It means to add a new port redirection table with an index number. <idx>: Enter an index number (1 to 20). <serv name>: Enter a name as service name. <proto>: Specify TCP or UDP or All as the protocol. <pub port>: Enter a value (0~65535). <src ip idx>: Enter an index number of source IP object profile. <pri ip>: Specify the private IP address of the internal host providing the service. <pri port>: Enter a value (0~65535). <wan1 ~ wan4>: Specify WAN interface for the port redirection. <alias IP>: Enter the index number (1~32) of alias IP.
<i>del</i> <idx>	It means to remove the selected port redirection setting. <idx>: Enter an index number (1 to 20).
<i>disable</i> <idx>	It means to inactivate the selected port redirection setting. <idx>: Enter an index number (1 to 20).
<i>enable</i> <idx> <proto>	It means to activate the selected port redirection setting. <idx>: Enter an index number (1 to 20). <proto>: Specify TCP or UDP or All as the protocol.
<i>flush</i>	It means to clear all the port mapping settings.
<i>table</i>	It means to display Port Redirection Configuration Table.

Example

```
> srv nat portmap add 1 name tcp 100 0 192.168.1.10 200 wan1 1
> srv nat portmap table
```

NAT Port Redirection Configuration Table:

Index	Service Name	Protocol	Public Port	Private IP	Private Port	ifno
1	name	TCP	100	192.168.1.10	200	-1
2		Disabled	0	0	-2	
3		Disabled	0	0	-2	
4		Disabled	0	0	-2	
5		Disabled	0	0	-2	
6		Disabled	0	0	-2	
...						

Telnet Command: `srv nat status`

This command allows users to view NAT Port Redirection Running Table.

Example

```
> srv nat status
```

NAT Port Redirection Running Table:

Index	Protocol	Public Port	Private IP	Private Port
1	6	100	192.168.1.11	200
2	0	0	0.0.0.0	0
3	0	0	0.0.0.0	0

4	0	0	0.0.0.0	0
5	0	0	0.0.0.0	0
6	0	0	0.0.0.0	0
7	0	0	0.0.0.0	0
8	0	0	0.0.0.0	0
9	0	0	0.0.0.0	0
10	0	0	0.0.0.0	0
11	0	0	0.0.0.0	0
12	0	0	0.0.0.0	0
13	0	0	0.0.0.0	0
14	0	0	0.0.0.0	0
15	0	0	0.0.0.0	0
16	0	0	0.0.0.0	0
17	0	0	0.0.0.0	0
18	0	0	0.0.0.0	0
19	0	0	0.0.0.0	0
20	0	0	0.0.0.0	0

--- MORE --- ['q': Quit, 'Enter': New Lines, 'Space Bar': Next Page] ---

Telnet Command: `srv nat showall`

This command allows users to view a summary of NAT port redirection setting, open port and DMZ settings.

Example

```
> srv nat showall
```

Index	Proto	WAN IP:Port	Private IP:Port	Act

R01	TCP	0.0.0.0:100	192.168.1.10:200	Y
D01	All	0.0.0.0	192.168.1.96	Y

Telnet Command: `sys admin`

This command is used for RD engineer to access into test mode of Vigor router.

Telnet Command: `sys board`

This command is used to disable/enable the function of default or wireless LAN button.

Syntax

`sys board button <def/wlan><on/off>`

Syntax Description

Parameter	Description
<code><def/wlan><on/off></code>	It means to set default usage of the button. <code><def></code> : Enter def (for factory default setting). <code><wlan></code> : Enter wlan (for wireless button). <code><on/off></code> : Enter on or off. It is used to disable/enable the function of the button.

	On - enable the button function. Off - disable the button function.
--	--

Example

```
> sys board button def on
> default button is on now.
```

Telnet Command: sys cfg

This command reset the router with factory default settings. When a user types this command, all the configuration will be reset to default setting.

Syntax

sys cfg default

sys cfg status

Syntax Description

Parameter	Description
<i>default</i>	It means to reset current settings with default values.
<i>status</i>	It means to display current profile version and status.

Example

```
> sys cfg status
Profile version: 3.0.0   Status: 1 (0x4845af2c)
> sys cfg default
>
```

Telnet Command: sys cmdlog

This command displays the history of the commands that you have typed.

Example

```
> sys cmdlog
[1] ?
[2] sys ?
[3] sys adminuser ?
[4] sys board ?
[5] sys board button ?
[6] sys board button def on
[7] sys cfg ?
[8] sys cfg status
[9] sys /
[10] sys cmdlog ?
[11] sys cmdlog
```

Telnet Command: sys ftpd

This command displays current status of FTP server.

Syntax

sys ftpd <on/off>

Syntax Description

Parameter	Description
<i><on/off></i>	<i><on></i> : Turn on the FTP server of the system. <i><off></i> : Turn off the FTP server of the system.

Example

```
> sys ftpd on
% sys ftpd turn on !!!
```

Telnet Command: sys domainname

This command can set and remove the domain name of the system when DHCP mode is selected for WAN.

Syntax

`sys domainname <wan1/wan2> <Domain Name Suffix>`

`sys domainname <wan1/wan2> clear`

Syntax Description

Parameter	Description
<i><wan1/wan2> <Domain Name Suffix></i>	<i><wan1/wan2></i> : Specify WAN interface for assigning a name for it. <i><Domain Name Suffix></i> : Enter a name. It means the name for the domain of the system. The maximum number of characters that you can set is 39.
<i><wan1/wan2> clear</i>	<i><wan1/wan2></i> : Specify WAN interface for assigning a name for it. <i><clear></i> : Remove the domain name of the system.

Example

```
> sys domainname wan1 clever
> sys domainname wan2 intellegent
> sys domainname ?
% sys domainname <wan1/wan2> <Domain Name Suffix (max. 39 characters)>
% sys domainname <wan1/wan2> clear
% Now: wan1 == clever, wan2 ==intellegent
>
```

Telnet Command: sys iface

This command displays the current interface connection status (UP or Down) with IP address, MAC address and Netmask for the router.

Example

```
> sys iface
Interface 0 Ethernet:
Status: UP
IP Address: 192.168.1.1      Netmask: 0xFFFFFFFF00 (Private)
IP Address: 0.0.0.0        Netmask: 0xFFFFFFFF
MAC: 00-50-7F-00-00-00
```

```

Interface 4 Ethernet:
Status: DOWN
IP Address: 0.0.0.0          Netmask: 0x00000000
MAC: 00-50-7F-00-00-02
Interface 5 Ethernet:
Status: DOWN
IP Address: 0.0.0.0          Netmask: 0x00000000
MAC: 00-50-7F-00-00-03
Interface 6 Ethernet:
Status: DOWN
IP Address: 0.0.0.0          Netmask: 0x00000000
MAC: 00-50-7F-00-00-04
Interface 7 Ethernet:
Status: DOWN
IP Address: 0.0.0.0          Netmask: 0x00000000
MAC: 00-50-7F-00-00-05
Interface 8 Ethernet:
Status: DOWN
IP Address: 0.0.0.0          Netmask: 0x00000000
MAC: 00-50-7F-00-00-06

--- MORE ---  ['q': Quit, 'Enter': New Lines, 'Space Bar': Next Page] ---
>

```

Telnet Command: sys name

This command can set and remove the name for the router when DHCP mode is selected for WAN.

Syntax

`sys name <wan1/wan2> <ASCII string>`

`sys name <wan1/wan2> clear`

Syntax Description

Parameter	Description
<code><wan1/wan2> <ASCII string></code>	It means to specify WAN interface for assigning a name for it. <code><wan1/wan2></code> : Specify WAN interface for assigning a name for it. <code><ASCII string></code> : Enter a string. The maximum number of characters that you can set is 39.
<code><wan1/wan2> clear</code>	It means the name for router. <code><wan1/wan2></code> : Specify WAN interface for assigning a name for it. <code><clear></code> : Remove the name of the system.

Example

```

> sys name wan1 drayrouter
> sys name ?
% sys name <wan1/wan2> <ASCII string (max. 39 characters)>
% sys name <wan1/wan2> clear
% Now: wan1 == drayrouter, wan2 ==
>

```

Note: Such name can be used to recognize router's identification in SysLog dialog.

Telnet Command: sys passwd

This command allows users to set password for the administrator.

```
sys passwd <old password> <new password: ASCII string>
```

Syntax Description

Parameter	Description
<i><old password></i> <i><new password: ASCII string></i>	<i><old password></i> : Enter the old password for administrator. <i><new password: ASCII string></i> : Enter the the password for administrator. The maximum number of characters that you can set is 23.

Example

```
> sys passwd admin admin123
> Password change successful !!!
> sys passwd admin123 admin
```

Telnet Command: sys reboot

This command allows users to restart the router immediately.

Example

```
> sys reboot
>
```

Telnet Command: sys autoreboot

This command allows users to restart the router automatically within a certain time.

Syntax

```
sys autoreboot [on/off/hour(s)]
```

Syntax Description

Parameter	Description
<i>on/off</i>	On - It means to enable the function of auto-reboot. Off - It means to disable the function of auto-reboot.
<i>hours</i>	It means to set the time schedule for router reboot. For example, if you type "2" in this field, the router will reboot with an interval of two hours.

Example

```
> sys autoreboot on
autoreboot is ON
> sys autoreboot 2
autoreboot is ON
autoreboot time is 2 hour(s)
```

Telnet Command: sys commit

This command allows users to save current settings to FLASH. Usually, current settings will be saved in SRAM. Yet, this command will save the file to FLASH.

Example

```
> sys commit
>
```

Telnet Command: sys tftpd

This command can turn on TFTP server for upgrading the firmware.

Example

```
> sys tftpd
% TFTP server enabled !!!
```

Telnet Command: sys version

This command can display current version for the system.

Example

```
DrayTek> sys version
Router Model: VigorLTE200n   Version: 3.8.12_RC2 English
Profile version: 3.0.0     Status: 1 (0x4844488c)
Router IP: 192.168.1.1     Netmask: 255.255.255.0
Firmware Build Date/Time: Apr 17 2019 19:00:48
Router Name: DrayTek
Revision: 81388 V388_2620L
```

Telnet Command: sys qrybuf

This command can display the system memory status and leakage list.

Example

```
> sys qrybuf
System Memory Status and Leakage List

Buf sk_buff ( 200B), used#: 1968, cached#: 21
Buf KMC5112 (5112B), used#: 257, cached#: 49
Buf KMC4088 (4088B), used#: 1, cached#: 7
Buf KMC2552 (2552B), used#: 1810, cached#: 434
Buf KMC1016 (1016B), used#: 17, cached#: 7
Buf KMC504 ( 504B), used#: 17, cached#: 31
Buf KMC248 ( 248B), used#: 87, cached#: 41
Buf KMC120 ( 120B), used#: 302, cached#: 402
Buf KMC56 ( 56B), used#: 139, cached#: 117
Buf KMC24 ( 24B), used#: 0, cached#: 0
Dynamic memory: 39321600B; 6458816B used; 1520192B/0B in level 1/2 cache.

FLOWTRACK Memory Status
# of free = 30000
# of maximum = 0
# of flowstate = 30000
# of lost by siganture = 0
# of lost by list = 0
```

Telnet Command: sys pollbuf

This command can turn on or turn off polling buffer for the router.

Syntax

sys pollbuf <on/off>

Syntax Description

Parameter	Description
<on/off>	<on>: Turn on pulling buffer. <off>: Turn off pulling buffer.

Example

```
> sys pollbuf on
% Buffer polling is on!

> sys pollbuf off
% Buffer polling is off!
```

Telnet Command: sys britask

This command can improve triple play quality.

Syntax

sys britask <on/off>

Syntax Description

Parameter	Description
<on/off>	<on>: Turn on the bridge task for improving the triple play quality. <off>: Turn off the bridge task.

Example

```
> sys britask on
% bridge task is ON, now
```

Telnet Command: sys tr069

This command can set CPE settings for applying in VigorACS.

Syntax

```
sys tr069 get int.  
sys tr069 get <parm> <nextlevel>  
sys tr069 set <parm> <value>  
sys tr069 getnoti <parm>  
sys tr069 setnoti <parm> <value>  
sys tr069 log  
sys tr069 debug <on/off>  
sys tr069 save  
sys tr069 clear  
sys tr069 inform <event code>  
sys tr069 port <port num>  
sys tr069 cert_auth <on/off>
```

Syntax Description

Parameter	Description
<i>get int.</i>	It means to get all of the parameters for TR-069.
<i>get <parm> <nextlevel></i>	It means to get configured value for the specified parameter. <parm>: Enter the abbreviation/full name of the parameter. For example, "Int." means Internet. "Man." means Management Server. Int.Man. = InternetGatewayDevice.ManagementServer. <nextlevel>: Get the information of the next level for specified parameter (e.g., sys tr069 get Int.Man. nextlevel).
<i>set <parm> <value></i>	It means to configure TR-069 parameters settings. Available parameters can be seen by using "get Int.". <parm>: Enter the abbreviation of the parameter. <value>: Enter the number, address, string, or name for the selected parameter.
<i>getnoti <parm></i>	It means to get notification value for the specified parameter. <parm>: Enter the abbreviation of the parameter.
<i>setnoti <parm> <value></i>	It means to configure notification value for TR-069 parameters. <parm>: Enter the abbreviation of the parameter. <value>: Enter the value for the selected parameter.
<i>log</i>	It means to display the TR-069 log.
<i>debug <on/off></i>	<on/off>: Enter on or off. on: turn on the function of sending debug message to syslog. off: turn off the function of sending debug message to syslog.
<i>save</i>	It means to save the parameters to the flash memory of the router.

<i>inform <event code></i>	It means to inform parameters for tr069 with different event codes. <event code>: Enter 0, 1, 2, 3, 4, 5, 6, 7, 8, 9 0, BOOTSTRAP 1, 1 BOOT 2, PERIODIC 3, SCHEDULED 4, VALUE CHANGE 5, KICKED 6, CONNECTION REQUEST 7, TRANSFER COMPLETE 8, DIAGNOSTICS COMPLETE 9, M Reboot
<i>port <port num></i>	It means to change tr069 listen port number. <port num>: Enter a port number (1-65535).
<i>cert_auth <on/off></i>	<on/off>: Enter on or off. on: turn on certificate-based authentication. off: turn off certificate-based authentication.

Example

```

> sys tr069 get Int. nextlevel
Total number of parameter is 24
Total content length of parameter is 915
InternetGatewayDevice.LANDeviceNumberOfEntries
InternetGatewayDevice.WANDeviceNumberOfEntries
InternetGatewayDevice.DeviceInfo.
InternetGatewayDevice.ManagementServer.
InternetGatewayDevice.Time.
InternetGatewayDevice.Layer3Forwarding.
InternetGatewayDevice.LANDevice.
InternetGatewayDevice.WANDevice.
InternetGatewayDevice.Services.
InternetGatewayDevice.X_00507F_InternetAcc.
InternetGatewayDevice.X_00507F_LAN.
InternetGatewayDevice.X_00507F_NAT.
InternetGatewayDevice.X_00507F_Firewall.
InternetGatewayDevice.X_00507F_Bandwidth.
InternetGatewayDevice.X_00507F_Applications.
InternetGatewayDevice.X_00507F_VPN.
InternetGatewayDevice.X_00507F_VoIP.
InternetGatewayDevice.X_00507F_WirelessLAN.
InternetGatewayDevice.X_00507F_System.
InternetGatewayDevice.X_00507F_Status.

InternetGatewayDevice.X_00507F_Diagnostics.
--- MORE ---  ['q': Quit, 'Enter': New Lines, 'Space Bar': Next Page] ---

```

Telnet Command: sys alg

This command can turn on/off ALG (Application Layer Gateway) for traversal.

Syntax

sys alg <1/0>

Syntax Description

Parameter	Description
<1/0>	<1/0>: Enter 1 or 0. 1, means to turn on ALG. 0, means to turn off ALG.

Example

```
> sys sip_alg ?
Usage: sys alg <command> <parameter>
-e: enable ALG (0:disable, 1:enable)

Current ALG status
-ALG Master Switch: Disabled
> sys alg -e 0
Disable ALG
```

Telnet Command: sys sip_alg

This command can turn on/off ALG (Application Layer Gateway) for SIP.

Syntax

sys sip_alg -e <1/0>

sys sip_alg -p <port number>

sys sip_alg -u <1/0>

sys sip_alg -t <1/0>

Syntax Description

Parameter	Description
-e <1/0>	<1/0>: Enter 1 or 0. Enable (1) or disable (0) the SIP ALG function.
-p <port number>	Set the listening port for SIP ALG. <port number>: Enter a port number (1~65535).
-u <1/0>	<1/0>: Enter 1 or 0. Enable (1) or disable (0) the listening along UDP path.
-t <1/0>	<1/0>: Enter 1 or 0. Enable (1) or disable (0) the listening along TCP path.

Example

```
> sys sip_alg -p 65535
Current listening port: 65535
```

Telnet Command: sys rtsp_alg

This command can turn on/off SIP ALG (Application Layer Gateway) for RTSP

Syntax

```
sys rtsp_alg -e <1/0>
```

```
sys rtsp_alg -p <port number>
```

```
sys rtsp_alg -u <1/0>
```

```
sys rtsp_alg -t <1/0>
```

```
sys rtsp_alg -v
```

Syntax Description

Parameter	Description
-e <1/0>	Enable (1) or disable (0) the function of RTSP ALG.
-p <port number>	Set the listening port for RTSP ALG. <port number>: Enter a port number (1~65535).
-u <1/0>	<1/0>: Enter 1 or 0. Enable (1) or disable (0) the listening along UDP path.
-t <1/0>	<1/0>: Enter 1 or 0. Enable (1) or disable (0) the listening along TCP path.
-v	Display RTP and RTCP portmap information of RTSP ALG.

Example

```
> sys rtsp_alg -e 1
Auto enable ALG Master Switch

Enable RTSP ALG

> sys rtsp_alg -p 85
Current listening RTSP Port: 85
> sys rtsp_alg ?
Usage: sys rtsp_alg <command> <parameter>
-e: enable RTSP ALG (0:disable, 1:enable)
-p: set your listening port for RTSP ALG
-u: enable listen along UDP path (0:disable, 1:enable)
-t: enable listen along TCP path (0:disable, 1:enable)
-v: show rtp and rtcp portmap information of RTSP ALG

Current RTSP ALG status
-ALG Master Switch: Enabled
-RTSP ALG: Enabled
-Listen along UDP path: Yes
-Listen along TCP path: Yes
-Listening Port: 85
-Max RTSP session num: 256
-Remain RTSP session num: 256
```

Telnet Command: sys license

This command can process the system license.

Note that DO NOT use the commands for system administrator only (for example, sys license licmsg, sys license licauth, and etc).

Syntax

sys license *reset_regser*

sys license *licifno* <AUTO/WAN#1>

sys license *lic_trigger* <-e/-d/-s>

Syntax Description

Parameter	Description
<i>reset_regser</i>	It means to reset the server as default setting, http://auth.draytek.com .
<i>licera</i>	It means to erase license setting.
<i>licifno</i> <AUTO/WAN#1>	It means license and signature download interface setting. <AUTO/WAN#1>: Enter AUTO or WAN1, WAN2, etc.
<i>lic_trigger</i> <-e/-d/-s>	It means to trigger the license automatically to update on boot time. -e : Enable the license trigger to update. -d : Disable the license trigger to update. -s : Display license status.

Example

```
> sys license licifno

License and Signature download interface setting:
licifno [AUTO/WAN#]

Ex: licifno wan1

Download interface is "auto-selected" now.

> sys license lic_trigger -e
Trigger the license to update, value=1

> sys license lic_trigger -d
Don't trigger the license to update, value=0

> sys license lic_trigger -s
License update state=0 (0:disable, 1:enable)
```

Telnet Command: sys daylightsave

This command is used to configure daylight save setting.

Syntax

sys daylightsave [-<command> <parameter> | ...]

Syntax Description

Parameter	Description
<command><parameter>/ ...	The available commands with parameters are listed below. [...] means that you can Enter several commands in one line.
-v	Display the daylight saving settings.
-r	Set to factory default setting.
-e <enable>	<enable>: Enter 1 or 0. Enable (1) / disable (0) daylight saving.
-t <type>	Specify the saving type for daylight setting. <type>: Enter 0, 1 or 2. 0 - Default 1 - Time range 2 - Yearly
-s <year> <month> <day> <hour>	Set the detailed settings of the starting day for time range type. <year>: Enter the year. <month>: Enter 1 ~ 12. <day>: Enter 1 ~ 31. <hour>: Enter 0 ~ 23. e.g., sys daylightsave -s 2014 3 10 12
-d <year> <month> <day> <hour>	Set the detailed settings of the ending day for time range type. <year>: Enter the year. <month>: Enter 1 ~ 12. <day>: Enter 1 ~ 31. <hour>: Enter 0 ~ 23. e.g., sys daylightsave -d 2014 9 10 12
-y <month> <th weekday> <day in week> <hour>	Set the detailed settings of the starting day for yearly type. <month>: Enter 1 ~ 12. <th weekday>: Enter 1 ~ 5, 9: last week <day in week>: Enter 0 ~6. 0:Sun, 1:Mon, 2:Tue, 3:Wed, 4:Thu, 5: Fri, 6:Sat <hour>: Enter 0 ~ 23. e.g, sys daylightsave -y 9 1 0 14
-z <month> <th weekday> <day in week> <hour>	Set the detailed settings of the ending day for yearly type. <month>: Enter 1 ~ 12. <th weekday>: Enter 1 ~ 5, 9: last week <day in week>: Enter 0 ~6. 0:Sun, 1:Mon, 2:Tue, 3:Wed, 4:Thu, 5: Fri, 6:Sat <hour>: Enter 0 ~ 23. e.g, sys daylightsave -z 3 1 6 14

Example

```
> sys daylightsave -y 9 1 0 14
% Start: Yearly on Sep 1th Sun 14:00
```

Telnet Command: sys dnsCacheTbl

This command is used to configure TTL settings which will be displayed in DNS Cache table.

Syntax

sys dnsCacheTbl <command><parameter>/...

Syntax Description

Parameter	Description
[<command><parameter> /...]	The available commands with parameters are listed below. [...] means that you can Enter several commands in one line.
-l	Display DNS IPv4 entry in the DNS cache table.
-s	Display DNS IPv6 entry in the DNS cache table.
-v	Display the TTL limit value in the DNS cache table.
-t <ttl>	Set the TTL limit value (seconds) in the DNS cache table. <ttl>: Enter 0 ~5. (0, no limit)
-c	Clear the DNS cache table.

Example

```
> sys dnsCacheTbl -l
%DNS Cache Table List
> sys dnsCacheTbl -t 65
% Set TTL limit: 65 seconds.
% When TTL larger than 65s , delete the DNS entry in the router's DNS cache
tabl
e.
>
```

Telnet Command: sys syslog

This command is used to enable / disable syslog.

Syntax

sys syslog -a <enable> [-<command> <parameter> | ...]

Syntax Description

Parameter	Description
<command><parameter>/... ...	The available commands with parameters are listed below. [...] means that you can Enter several commands in one line.
-a <enable>	Enable (1) or disable (0) Syslog Access Setup. <enable>: Enter 1 or 0.
-s <enable>	Enable (1) or disable (0) Syslog Save to Syslog Server. <enable>: Enter 1 or 0.
-i <IP>	Define the IP address of the Syslog server. <IP>: Enter the IP address (e.g., 192.168.5.66)
-d <port>	Define the port number as the destination port. <port>: Enter a port value (1~65535).
-u <enable>	Enable (1) or disable (0) Syslog Save to USB Disk. <enable>: Enter 1 or 0.
-m <enable>	Enable (1) or disable (0) Mail Syslog. <enable>: Enter 1 or 0.
-f <enable>	Enable (1) or disable (0) Firewall Log.

	<enable>: Enter 1 or 0.
-v <enable>	Enable (1) or disable (0) VPN Log. <enable>: Enter 1 or 0.
-e <enable>	Enable (1) or disable (0) User Access Log. <enable>: Enter 1 or 0.
-c <enable>	Enable (1) or disable (0) Call Log. <enable>: Enter 1 or 0.
-w <enable>	Enable (1) or disable (0) WAN Log. <enable>: Enter 1 or 0.
-r <enable>	Enable (1) or disable (0) Router/DSL Information. <enable>: Enter 1 or 0.
-t <enable>	Enable (1) or disable (0) AlertLog Setup. <enable>: Enter 1 or 0.
-o <port>	Define the port number for AlertLog. <port>: Enter a port value (1~65535).
-p	Update the IP address of the server.
-W <mode>	Define the action (1 for overwriting the oldest logs or 0 for stopping the logs) of syslog. <mode>: Enter 1 or 0.
-U <unit>	Set the unit (1 for MB or 0 for GB) of Syslog storing on a USB disk. <unit>: Enter 1 or 0.
-S <capacity>	Define the folder capacity of a USB disk. <capacity>: Enter 1~16GB or 1~1024MB.

Example

```
> sys syslog -a 1 -s 1 -i 192.168.1.25 -d 514
> sys syslog -p
> Updating server IP address..
```

Telnet Command: sys mailalert

This command is used to configure settings for mail alert function.

Syntax

sys mailalert <command><parameter>/...

Syntax Description

Parameter	Description
<command><parameter>/ ...	The available commands with parameters are listed below. [...] means that you can Enter several commands in one line.
-e <0/1>	Enable (1) or disable (0) the mail alert function. <0/1>: Enter 0 or 1.
-i <SMTP Server IP>	Set the SMTP sever IP address. <SMTP Server IP>: Enter an IP address.
-o <SMTP Server Port>	Set the port number for SMTP server. <SMTP Server Port>: Enter a number (1~65535).
-a <Mail Address>	Set Alert Mail Reciver E-maiil Address. <Mail Address>: Enter a mail address.
-r <Mail Address>	Set Mail Return E-mail Address. <Mail Address>: Enter a mail address.
-s <0/1>	Enable/Disable Use SSL. <0/1>: Enter 0 or 1.
-h <0/1>	Enable/Disable SMTP Authentication. <0/1>: Enter 0 or 1.
-u <Username>	Set Username for SMTP Authentication. <Username>: Enter a string as username.

<code>-p <Password></code>	Set Password for SMTP Authentication. <Password>: Enter a password.
<code>-l <type> <0 /1 ></code>	<type>: Enter 0, 1, 2 6. 0, Mail Alert of the DoS Attack. 1, Mail Alert of the APPE. 2, Mail Alert of the VPN Log. 6, Mail Alert of the Reboot Debug Log. <0/1>: Enter 0 (disable) or 1 (enable).
<code>-f</code>	Reset Mail Alert Setting to factory default.
<code>-v</code>	Show Current Mail Alert Setting.
<code>-R <0/1></code>	Set Mail Alert Reboot Debug Log Mode. <0/1>: Enter 0 or 1. 0, Limited Mode 1, Unlimited Mode

Example

```

> sys mailalert -e 1
Set Enable Mail Alert.
> sys mailalert -i 172.16.3.168
> sys mailalert -o 886
Set SMTP Server Port as 886
> sys mailalert -a john@draytek.com
Set Alert Mail Reciver E-maill Address as john@draytek.com
> sys mailalert -v
----- Current setting for Mail Alert -----
Mail Alert: Enable
SMTP Server IP Address: 172.16.3.168
SMTP Server Port: 886
Alert Mail Reciver E-maill Address: john@draytek.com
Mail Return E-mail Address:
Use SSL: Disable
SMTP Authentication: Disable
Username for SMTP Authentication:
Password for SMTP Authentication:
Mail Alert for DoS Attack: Enable.
Mail Alert for APPE: Enable.
Mail Alert for VPN Log: Enable.
Mail Alert for Reboot Debug Log: Disable, Mode: Limited.
-----
>

```

Telnet Command: sys time

This command is used to configure system time and date.

Syntax

`sys time server <domain>`

`sys time inquire`

`sys time show`

`sys time wan <option>`

`sys time zone <index>`

Syntax Description

Parameter	Description
-----------	-------------

<i>server <domain></i>	Set the domain name of the time server. <domain>: Enter a string. The maximum length is 39 characters.
<i>show</i>	Display the time server setting.
<i>wan <option></i>	Select WAN interface for applying the time server. <option>: Enter 0, 1, 2, 3 or 4. 0, Auto 1, WAN1 2, WAN2 3, WAN3 4, WAN4
<i>zone <Index></i>	Different number means different time zone. 1 - GMT-12:00 Eniwetok, Kwajalein 2 - GMT-11:00 Midway Island, Samoa 3 - GMT-10:00 Hawaii 4 - GMT-09:00 Alaska 5 - GMT-08:00 Pacific Time (US & Canada) 6 - GMT-08:00 Tijuana 7 - GMT-07:00 Mountain Time (US & Canada) 8 - GMT-07:00 Arizona 9 - GMT-06:00 Central Time (US & Canada) 10 - GMT-06:00 Saskatchewan 11 - GMT-06:00 Mexico City, Tegucigalpa 12 - GMT-05:00 Eastern Time (US & Canada) 13 - GMT-05:00 Indiana (East) 14 - GMT-05:00 Bogota, Lima, Quito 15 - GMT-04:00 Atlantic Time (Canada) 16 - GMT-04:00 Caracas, La Paz 17 - GMT-04:00 Santiago 18 - GMT-03:30 Newfoundland 19 - GMT-03:00 Brasilia 20 - GMT-03:00 Buenos Aires, Georgetown 21 - GMT-02:00 Mid-Atlantic 22 - GMT-01:00 Azores, Cape Verde Is. 23 - GMT Greenwich Mean Time : Dublin 24 - GMT Edinburgh, Lisbon, London 25 - GMT Casablanca, Monrovia 26 - GMT+01:00 Belgrade, Bratislava 27 - GMT+01:00 Budapest, Ljubljana, Prague 28 - GMT+01:00 Sarajevo, Skopje, Sofija 29 - GMT+01:00 Warsaw, Zagreb 30 - GMT+01:00 Brussels, Copenhagen 31 - GMT+01:00 Madrid, Paris, Vilnius 32 - GMT+01:00 Amsterdam, Berlin, Bern 33 - GMT+01:00 Rome, Stockholm, Vienna 34 - GMT+02:00 Bucharest 35 - GMT+02:00 Cairo 36 - GMT+02:00 Helsinki, Riga, Tallinn 37 - GMT+02:00 Athens, Istanbul, Minsk 38 - GMT+02:00 Jerusalem 39 - GMT+02:00 Harare, Pretoria 40 - GMT+03:00 Volgograd 41 - GMT+03:00 Baghdad, Kuwait, Riyadh 42 - GMT+03:00 Nairobi 43 - GMT+03:00 Moscow, St. Petersburg 44 - GMT+03:30 Tehran 45 - GMT+04:00 Abu Dhabi, Muscat 46 - GMT+04:00 Baku, Tbilisi 47 - GMT+04:30 Kabul 48 - GMT+05:00 Ekaterinburg 49 - GMT+05:00 Islamabad, Karachi, Tashkent

50 - GMT+05:30 Bombay, Calcutta
51 - GMT+05:30 Madras, New Delhi
52 - GMT+06:00 Astana, Almaty, Dhaka
53 - GMT+06:00 Colombo
54 - GMT+07:00 Bangkok, Hanoi, Jakarta
55 - GMT+08:00 Beijing, Chongqing
56 - GMT+08:00 Hong Kong, Urumqi
57 - GMT+08:00 Singapore
58 - GMT+08:00 Taipei
59 - GMT+08:00 Perth
60 - GMT+09:00 Seoul
61 - GMT+09:00 Osaka, Sapporo, Tokyo
62 - GMT+09:00 Yakutsk
63 - GMT+09:30 Darwin
64 - GMT+09:30 Adelaide
65 - GMT+10:00 Canberra, Melbourne, Sydney
66 - GMT+10:00 Brisbane
67 - GMT+10:00 Hobart
68 - GMT+10:00 Vladivostok
69 - GMT+10:00 Guam, Port Moresby
70 - GMT+11:00 Magadan, Solomon Is.
71 - GMT+11:00 New Caledonia
72 - GMT+12:00 Fiji, Kamchatka, Marshall Is.
73 - GMT+12:00 Auckland, Wellington

Example

```

> sys time zone 8
Set Time Zone OK

> sys time show
***** System Time *****
Current System Time: [2000 Jan 03 Mon 06:11:12]
Time Server: [pool.ntp.org]
Time Zone Index: [8]. GMT-07:00
Send NTP Request Through: Auto
*****

```

Telnet Command: sys dashboard

This command is used to display or hidden the information displayed on the dashboard.

Syntax

sys dashboard show

sys dashboard -<command> <value> ...

Syntax Description

Parameter	Description
<command><parameter>/ ...	The available commands with parameters are listed below. <...> means that you can Enter several commands in one line.
- <command> <value>	<command>: Enter 0, 1, 2, 3,4, 5, 6, 7, 8, 9 adn a 0, Front Panel 1, System Information 2, IPv4 LAN Information 3, IPv4 Internet Access

4, IPv6 Internet Access
5, Interface
6, Security
7, System Resource
8, LTE Status
9, Quick Access
a, VoIP
<value>: Enter 1 or 0.
1, Enable
0, Disable

Example

```
> sys dashboard -1 1 -2 0
System Information enabled
IPv4 LAN Information disabled
```

Telnet Command: testmail

This command is used to display current settings for sending test mail.

Example

```
> testmail
Send out test mail
Mail Alert:[Disable]
SMTP_Server:[0.0.0.0]
Mail to:[]
Return-Path:[]
```

Telnet Command: upnp off

This command can close UPnP function.

Example

```
>upnp off
UPNP say bye-bye
```

Telnet Command: upnp on

This command can enable UPnP function.

Example

```
>upnp on
UPNP start.
```

Telnet Command: upnp nat

This command can display IGD NAT status.

Example

```
> upnp nat ?
***** IGD NAT Status *****
```

```

((0))
InternalClient >>192.168.1.10<<, RemoteHost >>0.0.0.0<<
InternalPort >>21<<, ExternalPort >>21<<
PortMapProtocol >>TCP<<
The tmpvirtual server index >>0<<
PortMapLeaseDuration >>0<<, PortMapEnabled >>0<<
Ftp Example [MICROSOFT]
((1))
InternalClient >>0.0.0.0<<, RemoteHost >>0.0.0.0<<
InternalPort >>0<<, ExternalPort >>0<<
PortMapProtocol >><NULL><<
The tmpvirtual server index >>0<<
PortMapLeaseDuration >>0<<, PortMapEnabled >>0<<
PortMapProtocol >><NULL><<
The tmpvirtual server index >>0<<
PortMapLeaseDuration >>0<<, PortMapEnabled >>0<<
0<<

--- MORE --- ['q': Quit, 'Enter': New Lines, 'Space Bar': Next Page] ---

```

Telnet Command: upnp service

This command can display the information of the UPnP service. UPnP service must be enabled first.

Example

```

> upnp on
UPNP start.

> upnp service
>>>> SERVICE TABLE1 <<<<<
  serviceType urn:schemas-microsoft-com:service:OSInfo:1
  serviceId   urn:microsoft-com:serviceId:OSInfo1
  SCPDURL     /upnp/OSInfo.xml
  controlURL  /OSInfo1
  eventURL    /OSInfoEvent1
  UDN         uuid:774e9bbe-7386-4128-b627-001daa843464

>>>> SERVICE TABLE2 <<<<<
  serviceType urn:schemas-upnp-org:service:WANCommonInterfaceConfig:1
  serviceId   urn:upnp-org:serviceId:WANCommonIFC1
  SCPDURL     /upnp/WComIFCX.xml
  controlURL  /upnp?control=WANCommonIFC1
  eventURL    /upnp?event=WANCommonIFC1
  UDN         uuid:2608d902-03e2-46a5-9968-4a54ca499148
.
.
.

```

Telnet Command: upnp subscribe

This command can show all UPnP services subscribed.

Example

```

> upnp on

```

```

UPNP start.
> upnp subscribe
>>>> (1) serviceType urn:schemas-microsoft-com:service:OSInfo:1

>>>> (2) serviceType
urn:schemas-upnp-org:service:WANCommonInterfaceConfig:1

>>>> (3) serviceType urn:schemas-upnp-org:service:WANPOTSLinkConfig:1

>>>> (4) serviceType urn:schemas-upnp-org:service:WANPPPConnection:1

>>>> (5) serviceType urn:schemas-upnp-org:service:WANIPConnection:1

```

Telnet Command: upnp tmpvs

This command can display current status of temp Virtual Server of your router.

Example

```

Vigor> upnp tmpvs
***** Temp virtual server status *****

((0))
real_addr >>192.168.1.10<<, pseudo_addr >>172.16.3.229<<
real_port >>0<<, pseudo_port >>0<<
hit_portmap_index >>0<<
The protocol >>TCP<<
time >>0<<

((1))
real_addr >>0.0.0.0<<, pseudo_addr >>0.0.0.0<<
real_port >>0<<, pseudo_port >>0<<
hit_portmap_index >>0<<
The protocol >>0<<
time >>0<<
--- MORE ---  ['q': Quit, 'Enter': New Lines, 'Space Bar': Next Page] ---

```

Telnet Command: upnp wan

This command is used to specify WAN interface to apply UPnP.

Syntax

upnp wan <n>

Syntax Description

Parameter	Description
<n>	It means to specify WAN interface to apply UPnP. <n>: Enter 0 ~3. 0, auto-select WAN interface. 1, WAN1 2, WAN2 3, WAN3

Example

```
> upnp wan 1
```

```
use wan1 now.
```

Telnet Command: **vigbrg set**

This command is to configure specified WAN as bridge mode.

Syntax Description

```
vigbrg set -v <IP version> -w <WAN_idx> -l <LAN_idx> -e <0/1> -f <0/1>
```

Syntax Description

Parameter	Description
<pre>-v <IP version> -w <WAN_idx> -l <LAN_idx> -e <0/1> -f <0/1></pre>	<p>-v <IP version>: Enter 4 or 6. Indicate the IP version for the IP address.</p> <ul style="list-style-type: none">4, IPv4.6, IPv6. <p>-w <WAN_idx>: Enter 1. Indicate the WAN interface.</p> <ul style="list-style-type: none">1, WAN1 <p>-l <LAN_idx>: Enter 1, or 2. Indicate the LAN interface.</p> <ul style="list-style-type: none">1, LAN12, LAN2 <p>-e <0/1>: Enter 0 or 1 to enable/disable the Vigor Bridge for WAN or/and LAN.</p> <p>-f <0/1>: Enter 0 or 1 to enable/disable the firewall functions.</p> <ul style="list-style-type: none">0, disable1, enable

Example

```
> vigbrg set -v 4 -w 1 -l 1 -e 1  
[WAN1] IPv4 bridge is enable. Set subnet[LAN1]
```

Telnet Command: **vigbrg closeall**

This command can close Vigor Bridge Function.

Example

```
> vigbrg closeall ?  
Close all bridge and bridge firewall  
[WAN1] IPv4 firewall is disable.
```

Telnet Command: **vigbrg status**

This command can show whether the Vigor Bridge Function is enabled or disabled.

Example

```
> vigbrg status  
Show gConfig setting of bridge mode  
[WAN1] IPv4 bridge is enable [LAN1].
```

Telnet Command: **vigbrg cfgip**

This command allows users to transfer a bridge modem into ADSL router by accessing into and adjusting specified IP address. Users can access into Web UI of the router to manage the router through the IP address configured here.

Syntax

vigbrg cfgip <IP Address>

Syntax Description

Parameter	Description
<IP Address>	It means to type an IP address for users to manage the router. <IP Address>: Enter an IP address.

Example

```
> vigbrg cfgip 192.168.1.15
> vigbrg cfgip ?
% Vigor Bridge Config IP,
% Now: 192.168.1.15
```

Telnet Command: vlan group

This command allows you to set VLAN group. You can set four VLAN groups. Please run *vlan restart* command after you change any settings.

Syntax

vlan group *id* <set/set_ex> <p1/p2/p3/p4/s1/s2/s3/s4>

Syntax Description

Parameter	Description
<i>id</i> <set/set_ex> <p1/p2/p3/p4/s1/s2/s3/s4>	Id: Enter 0 ~ 7. It means the group 0 to 7 for VLAN. <set/set_ex>: Enter set or set_ex to let the selected port number joining a VLAN group. In which, "set" indicates each port can join more than one VLAN group. "set_ex" indicates each port can join one VLAN group. <p1/p2/p3/p4/s1/s2/s3/s4>: Enter p1, p2, p3, p4, s1, s2, s3 or s4. In which, p1, p2, p3 and p4 mean LAN port 1 to LAN port 4. To group LAN1, LAN2, LAN3 and/or LAN4 under one VLAN group, please enter the port number(s) you want. S1, s2, s3 and s4 are configured for WLAN function.

Example

```
> vlan group 3 set p1 s3 s4
VLAN  p1  p2  p3  p4  s1  s2  s3  s4
-----
   3   v                v   v
>
```

Telnet Command: vlan off

This command allows you to disable VLAN function.

Syntax

vlan off

Example

```
> vlan off
VLAN is Disable!
Force subnet LAN2 to be disabled!!
```

Telnet Command: vlan on

This command allows you to enable VLAN function.

Syntax

vlan on

Example

```
> vlan on
VLAN is Enable!
```

Telnet Command: vlan pri

This command is used to define the priority for each VLAN profile setting.

Syntax

vlan pri *n pri_no*

Syntax Description

Parameter	Description
<i>n pri_no</i>	n: Enter 0 ~ 7. It means VLAN ID number. pri_no: Enter 0 ~ 7 (from none to highest priority). It means the priority of VLAN profile.

Example

```
> vlan pri 1 2
VLAN1: Priority=2
```

Telnet Command: vlan restart

This command can make VLAN settings restarted with newest configuration.

Syntax

vlan restart

Example

```
> vlan restart ?
VLAN restarts!!!
```

Telnet Command: vlan status

This command display current status for VLAN.

Syntax

vlan status

Example

```

> vlan status
VLAN is Enable :
-----
VLAN Enable VID Pri p1 p2 p3 p4 s1 s2 s3 s4 subnet
-----
0 OFF 0 0 1:LAN1
1 OFF 0 2 1:LAN1
2 OFF 0 0 1:LAN1
3 OFF 0 0 V V V 1:LAN1
4 OFF 0 0 1:LAN1
5 OFF 0 0 1:LAN1
6 OFF 0 0 1:LAN1
7 OFF 0 0 1:LAN1
-----
Note: they are only untag for s1/s2/s3/s4, but they can join tag vlan with
lan ports.
Permit untagged device in P1 to access router: ON.

```

Telnet Command: vlan subnet

This command is used to configure the LAN interface used by the VLAN group.

Syntax

```
vlan subnet group_id <1/2>
```

Syntax Description

Parameter	Description
<1/2>	<1/2>: Enter 1 or 2. 1, LAN1 2, LAN2

Example

```

> vlan subnet group_id 2
% Vlan Group-0 using LAN2      !

This setting will take effect after rebooting.
Please use "sys reboot" command to reboot the router.
drayrouter> vlan subnet
%% vlan subnet group_id <1/2>
% Now
% VLAN0: 2(LAN2      )
% VLAN1: 1(LAN1      )
% VLAN2: 1(LAN1      )
% VLAN3: 1(LAN1      )
% VLAN4: 1(LAN1      )
% VLAN5: 1(LAN1      )
% VLAN6: 1(LAN1      )
% VLAN7: 1(LAN1      )

>

```

Telnet Command: vlan submode

This command changes the VLAN encapsulation mechanisms in the LAN driver.

Syntax

`vlan submode <on/off/status>`

Syntax Description

Parameter	Description
<code><on/off/status></code>	<code><on/off/status></code> : Enter on, off or status to enable, disable or display the submode status. on, means to enable the promiscuous mode. off, means to disable the promiscuous mode. status, means to display if submode is normal mode or promiscuous mode.

Example

```
> vlan submode status
% vlan subnet mode : normal mode
> vlan submode on
% vlan subnet mode modified to promiscuous mode.
> vlan submode status
% vlan subnet mode : promiscuous mode
```

Telnet Command: vlan tagged

This command is used to enable or disable the incoming of untagged packets.

Syntax

`vlan tagged <n> <on/off>`

`vlan tagged unlimited <on/off>`

`vlan tagged p1_untag <on/off>`

Syntax Description

Parameter	Description
<code><n> <on/off></code>	<code><n></code> : Enter 0 to 7. It means VLAN channel. <code><on/off></code> : Enter on or off to enable/disable the tagged VLAN. on, enable off, disable
<code>unlimited <on/off></code>	<code>unlimited <on/off></code> : Allow/forbid the incoming of untagged packets even all VLAN are tagged. on, allow off, forbid
<code>p1_untag <on/off></code>	<code>p1_untag <on/off></code> : Allow/forbid the incoming of untagged packets form LAN port 1. on, allow off, forbid

Example

```
> vlan tagged unlimited on
unlimited mode is ON
```

Telnet Command: vlan vid

This command is used to configure VID number for each VLAN channel.

Syntax

```
vlan vid n vid_no
```

Syntax Description

Parameter	Description
<i>n vid_no</i>	n: Enter 0 ~ 7. It means VLAN channel. Vid_no: Enter 0 ~ 4095. It means the value of VLAN ID. Enter the value as the VLAN ID number.

Example

```
> vlan vid 1 4095
VLAN1, vid=4095
```

Telnet Command: vlan sysvid

This command is used to modify and show the scope (reserved 78) of the VLAN IDs used internally by the system.

Syntax

```
vlan sysvid show/<n>
```

Syntax Description

Parameter	Description
<i>show</i>	It means to show the scope of VLAN ID used internally.
<i><n></i>	<i><n></i> : Enter 0 ~ 4016. It means the value to be set as VLAN ID.

Example

```
> vlan sysvid 100
You have set system VLAN ID to range: 100 ~ 177,
We recommend that you reboot the system now.

> vlan sysvid 200
You have set system VLAN ID to range: 200 ~ 263,
We recommend that you reboot the system now.

> vlan sysvid show
The system VLAN ID is in range: 200 ~ 263
```

Telnet Command: vpn l2lset

This command allows users to set advanced parameters for LAN to LAN function.

Syntax

```
vpn l2lset <list index> peerid <peerid>
vpn l2lset <list index> localid <localid>
vpn l2lset <list index> main <auto/proposal index>
vpn l2lset <list index> aggressive <desg1/desg2/aesg1/aesg2>
vpn l2lset <list index> pfs <on/off>
vpn l2lset <list index> phase1 <lifetime>
vpn l2lset <list index> phase2 <lifetime>
vpn l2lset <list index> x509localid <0/1>
```

Syntax Description

Parameter	Description
<i><list index> peerid <peerid></i>	<i><list index></i> : Enter the index number of L2L (LAN to LAN) profile. <i><peerid></i> : Enter the peer identity for aggressive mode.
<i><list index> localid <localid></i>	<i><list index></i> : Enter the index number of L2L (LAN to LAN) profile. <i><localid></i> : Enter the local identity for aggressive mode.
<i><list index> main <auto/proposal index></i>	It means to choose proposal for main mode. <i><list index></i> : Enter the index number of L2L (LAN to LAN) profile. <i><auto/proposal index></i> : Enter auto or proposal index number to choose the default proposal or specified proposal.
<i><list index> aggressive <desg1/desg2/aesg1/aesg2></i>	It means the chosen DH group for aggressive mode. <i><list index></i> : Enter the index number of L2L (LAN to LAN) profile. <i><desg1/desg2/aesg1/aesg2></i> : Enter desg1, desg2, aesg1 or aesg2.
<i><list index> pfs <on/off></i>	It means "perfect forward secrete". <i><list index></i> : Enter the index number of L2L (LAN to LAN) profile. <i><on/off></i> : Enter or or off to turn on/off the PSF configuration.
<i><list index> phase1 <lifetime></i>	It means to set the lifetime value for phase 1 of IKE. <i><list index></i> : Enter the index number of L2L (LAN to LAN) profile. <i><lifetime></i> : Enter a value.
<i><list index> phase2 <lifetime></i>	It means to set the lifetime value for phase 2 of IKE. <i><list index></i> : Enter the index number of L2L (LAN to LAN) profile. <i><lifetime></i> : Enter a value.
<i><list index> X509localid <0/1></i>	It means the local identity for X509 server. <i><list index></i> : Enter the index number of L2L (LAN to LAN) profile. <i><0/1></i> : Enter 1 or 0 to enable or disable the local identity configuration of X509 server.

Example

```
> vpn l2lset 1 peerid test
```

Telnet Command: vpn dinset

This command allows users to configure setting for remote dial-in VPN profile.

Syntax

```
vpn dinset <list index>
vpn dinset <list index> <on/off>
vpn dinset <list index> username <USERNAME>
vpn dinset <list index> password <PASSWORD>
vpn dinset <list index> motp <on/off>
vpn dinset <list index> pin_secret <pin> <secret>
vpn dinset <list index> timeout <0-9999>
vpn dinset <list index> dintype <Type> <on/off>
vpn dinset <list index> subnet <0-2>
vpn dinset <list index> assignip <on/off>
vpn dinset <list index> srnode <on/off>
vpn dinset <list index> remoteip <Remote_Client_IP_Address>
vpn dinset <list index> peer <Peer_ID>
vpn dinset <list index> naming <pass/block>
vpn dinset <list index> multicastvpn <pass/block>
vpn dinset <list index> prekey <on/off>
vpn dinset <list index> assignkey <Pre_Shared_Key>
vpn dinset <list index> digsig <on/off>
vpn dinset <list index> ipsec <Method> <on/off>
vpn dinset <list index> localid <Local_ID>
```

Syntax Description

Parameter	Description
<list index>	<list index>: Enter the index number of L2L (LAN to LAN) profile.
<list index> <on/off>	It means to enable or disable the profile. <list index>: Enter the index number of L2L (LAN to LAN) profile. <on/off>: Enter on or off. On, Enable. Off, Disable.
<list index> username <USERNAME>	It means to set a username for dial-in VPN profile. <list index>: Enter the index number of L2L (LAN to LAN) profile. <USERNAME>: Enter a string.
<list index> password <PASSWORD>	It means to set a password for dial-in VPN profile. <list index>: Enter the index number of L2L (LAN to LAN) profile. <PASSWORD>: Enter a password.
<list index> motp <on/off>	It means to enable or disable the authentication with mOTP function. <list index>: Enter the index number of L2L (LAN to LAN) profile. <on/off>: Enter on or off. On, Enable. Off, Disable.
<list index>	It means to set PIN code with secret.

<i>pin_secret</i> <pin> <secret>	<p><list index>: Enter the index number of L2L (LAN to LAN) profile.</p> <p><pin>: Enter the code for authentication (e.g., 1234).</p> <p><secret>: Use the 32 digit-secret number generated by mOTP in the mobile phone (e.g., e759bb6f0e94c7ab4fe6)</p>
<i><list index> timeout</i> <i><0-9999></i>	<p>It means to set the time out for dial-in VPN profile.</p> <p><list index>: Enter the index number of L2L (LAN to LAN) profile.</p> <p><0-9999>: Enter a number. The default is 300 seconds.</p>
<i><list index> dintype</i> <i><Type> <on/off></i>	<p>It means to set dial-in type for creating VPN connection.</p> <p><list index>: Enter the index number of L2L (LAN to LAN) profile.</p> <p><Type>: 0:PPTP,1:IPsec Tunnel,2:L2TP with IPsec Policy,3:SSL Tunnel</p> <p><on/off>: Enter on or off. On, Enable. Off, Disable.</p>
<i><list index> subnet</i> <0-2>	<p>It means to set the LAN subnet for the VPN profile.</p> <p><list index>: Enter the index number of L2L (LAN to LAN) profile.</p> <p><0-2>: Enter 0, 1 or 2. 0:LAN1 1:LAN2 2:LAN3</p>
<i><list index> assignip</i> <i><on/off></i>	<p>It means to enable the assignment for static IP address.</p> <p><list index>: Enter the index number of L2L (LAN to LAN) profile.</p> <p><on/off>: Enter on or off. On, Enable. Off, Disable.</p>
<i><list index> srnode</i> <i><on/off></i>	<p>It means to enable the function of Specify Remote Node.</p> <p><list index>: Enter the index number of L2L (LAN to LAN) profile.</p> <p><on/off>: Enter on or off. On, Enable. Off, Disable.</p>
<i><list index>remoteip</i> <i><Remote_Client_IP_Address></i>	<p>It means to assign the IP address for the remote client.</p> <p><list index>: Enter the index number of L2L (LAN to LAN) profile.</p> <p><Remote_Client_IP_Address>: Enter the IP address.</p>
<i><list index> peer</i> <i><Peer_ID></i>	<p>It means to assign the peer ID for such profile.</p> <p><list index>: Enter the index number of L2L (LAN to LAN) profile.</p> <p><Peer_ID>: Enter the peer ID.</p>
<i><list index> naming</i> <i><pass/block></i>	<p><list index>: Enter the index number of L2L (LAN to LAN) profile.</p> <p><pass/block>: Enter pass or block. Pass, have an inquiry for data transmission between the hosts located on both sides of VPN Tunnel while connecting.</p>

	Block, when there is conflict occurred between the hosts on both sides of VPN Tunnel in connecting, it can block data transmission of Netbios Naming Packet inside the tunnel.
<i><list index> multicastvpn <pass/block></i>	<p><i><list index></i>: Enter the index number of L2L (LAN to LAN) profile.</p> <p><i><pass/block></i>: Enter pass or block.</p> <p>Pass -Let multicast packets pass through the router.</p> <p>Block - This is default setting. It can let multicast packets be blocked by the router.</p>
<i><list index> prekey <on/off></i>	<p>It means to enable/disable the pre-shared key for IKE authentication method.</p> <p><i><list index></i>: Enter the index number of L2L (LAN to LAN) profile.</p> <p><i><on/off></i>: Enter on or off.</p> <p>On, Enable.</p> <p>Off, Disable.</p>
<i><list index> assignkey <Pre_Shared_Key></i>	<p>Assign the pre-shared key.</p> <p><i><list index></i>: Enter the index number of L2L (LAN to LAN) profile.</p> <p><i><Pre_Shared_Key></i>: Enter a string.</p>
<i><list index> digsig <on/off></i>	<p>Enable /disable the function of Digital Signature (X.509) for IKE authentication method.</p>
<i><list index> ipsec <Method> <on/off></i>	<p>Set the IPsec security method for the specified VPN profile.</p> <p><i><list index></i>: Enter the index number of L2L (LAN to LAN) profile.</p> <p><i><Method></i>: Enter 0, 1, 2 or 3.</p> <p>0, Medium(AH) High(ESP)</p> <p>1, DES</p> <p>2, 3DES</p> <p>3, AES</p> <p><i><on/off></i>: Enter on or off.</p> <p>On, Enable.</p> <p>Off, Disable..</p>
<i><list index> localid <Local_ID></i>	<p>Assign a local ID to be used for Dial-in setting in the LAN-to-LAN Profile setup.</p> <p><i><list index></i>: Enter the index number of L2L (LAN to LAN) profile.</p> <p><i><Local_ID></i>: Enter a string.</p>

Example

```

> vpn dinset 1

Dial-in profile index 1

Profile Name: ???
Status: Deactive

Mobile OTP: Disabled

Password:

```

```

Idle Timeout: 300 sec

> vpn dinset 1 on
% set profile active

> vpn dinset 1 motp on
% Enable Mobile OTP mode!>
> vpn dinset 1 pin_secret 1234 e759bb6f0e94c7ab4fe6
> vpn dinset 1

Dial-in profile index 1

Profile Name: ???
Status: Active

Mobile OTP: Enabled

PIN: 1234

Secret: e759bb6f0e94c7ab4fe6

Idle Timeout: 300 sec

```

Telnet Command: vpn subnet

This command allows users to specify a subnet selection for the specified remote dial-in VPN profile.

Syntax

```
vpn subnet <index> <1/2>
```

Syntax Description

Parameter	Description
<index> <1/2>	It means the index number of the VPN profile. <index>: Enter the index number of L2L (LAN to LAN) profile. <1/2>: Enter 1 or 2. 1, LAN1 2, LAN2

Example

```

> vpn subnet 1 2
>

```

Telnet Command: vpn setup

This command allows users to setup VPN for different types.

Syntax

Command of PPTP Dial-Out

```
vpn setup <index> <name> pptp_out <ip> <usr> <pwd> <nip> <nmask>
```

Command of IPSec Dial-Out

vpn setup <index> <name> ipsec_out <ip> <key> <nip> <nmask>

Command of L2Tp Dial-Out

vpn setup <index> <name> l2tp_out <ip> <usr> <pwd> <nip> <nmask>

Command of Dial-In

vpn setup <index> <name> dialin <ip> <usr> <pwd> <key> <nip> <nmask>

Syntax Description

Parameter	Description
For PPTP Dial-Out	
<index> <name> pptp_out <ip> <usr> <pwd> <nip> <nmask>	<index>: Enter the index number of L2L (LAN to LAN) profile. <name>: Enter the name of the profile. <ip>: Enter the IP address to dial to. <usr>: Enter the user name for the PPTP connection. <pwd>: Enter the password required for the PPPT connection. <nip>: Enter the remote network IP address. <nmask>: Enter the mask for the remote network IP. e.g., vpn setup 1 name1 pptp_out 1.2.3.4 vigor 1234 192.168.1.0 255.255.255.0
For IPsec Dial-Out	
<index> <name> ipsec_out <ip> <key> <nip> <nmask>	<index>: Enter the index number of L2L (LAN to LAN) profile. <name>: Enter the name of the profile. <ip>: Enter the IP address to dial to. <key>: Enter the value of IPsec Pre-Shared Key. <nip>: Enter the remote network IP address. <nmask>: Enter the mask for the remote network IP. e.g., vpn setup 1 name1 ipsec_out 1.2.3.4 1234 192.168.1.0 255.255.255.0
For L2TP Dial-Out	
<index> <name> l2tp_out <ip> <usr> <pwd> <nip> <nmask>	<index>: Enter the index number of L2L (LAN to LAN) profile. <name>: Enter the name of the profile. <ip>: Enter the IP address to dial to. <usr>: Enter the user name for the PPTP connection. <pwd>: Enter the password required for the PPPT connection. <nip>: Enter the remote network IP address. <nmask>: Enter the mask for the remote network IP. e.g., vpn setup 1 name1 l2tp_out 1.2.3.4 vigor 1234 192.168.1.0 255.255.255.0
For Dial-In	
<index> <name> dialin <ip> <usr> <pwd> <key> <nip> <nmask>	<index>: Enter the index number of L2L (LAN to LAN) profile. <name>: Enter the name of the profile. <ip>: Enter the IP address to dial to.

	<p><usr>: Enter the user name for the PPTP connection.</p> <p><pwd>: Enter the password required for the PPTP connection.</p> <p><key>: Enter the value of IPsec Pre-Shared Key.</p> <p><nip>: Enter the remote network IP address.</p> <p><nmask>: Enter the mask for the remote network IP.</p> <p>e.g.,</p> <pre>vpn setup 1 name1 dialin 1.2.3.4 vigor 1234 abc 192.168.1.0 255.255.255.0</pre>
--	---

Example

```
> vpn setup 1 name1 dialin 1.2.3.4 vigor 1234 abc 192.168.1.0 255.255.255.0
% Profile Change Log ...

% Profile Index : 1
% Profile Name : name1
% Username : vigor
% Password : 1234
% Pre-share Key : abc
% Call Direction : Dial-In
% Type of Server : ISDN PPTP IPsec L2TP
% Dial from : 1.2.3.4
% Remote Network IP : 192.168.1.0
% Remote Network Mask : 255.255.255.0
>
```

Telnet Command: vpn option

This command allows users to configure settings for LAN to LAN profile.

Syntax

vpn option <index> <cmd1>=<param1> <cmd2>=<para2>/ ...

Commands of Common Settings

vpn optoin <index> <pname=> <ena=> <nnpkt=> <dir=> <idle=> <palive=>

Commands of Dial-Out Settings

vpn optoin <index> <ctype=> <dialto=> <ltype=> <oname=> <opwd=> <pauth=> <ovj=>
<okey=> <ometh=> <sch=> <ikemode=> <ikeid=>

Commands of Dial-In Settings

vpn optoin <index> <itype=> <peer=> <peerid=> <iname=> <ipwd=> <ivj=> <ikkey=>
<imeth=>

Commands of TCP/IP Network Settings

vpn optoin <index> <mywip=> <rgip=> <rnip=> <rnmask=> <lnip=> <lnmask=> <rip=>
<mode=> <droute=>

Syntax Description

Parameter	Description
For Common Settings	
<index> <pname=>	<index>: Enter the index number of L2L (LAN to LAN) profile.
<ena=> <nnpkt=> <dir=>	<pname=>: Enter pname=the name of the profile (e.g.,

<p><idle=> <palive=></p>	<p>pname=testname).</p> <p><ena=>: Enter ena=on or ena=off. In which, on means Enable, off means disable.</p> <p><nnpkt=>: Enter nnpkt=on or nnpkt=off to pass or block the NetBios Naming Packet. In which, on means pass, off means block.</p> <p><dir=>: Enter dir=b, dir=o or dir=i to determine the call direction. In which, b means Both, o means Dial-Out and i means Dial-In.</p> <p><idle=>: Enter idle=-1, idle=0 or idle=other value. In which, -1 means always on for dial-out, 0 means always on for dial-in. Other numbers (e.g., idle=200, idle=300, idle=500) mean the router will be idle after the interval (seconds) configured here.</p> <p><palive=>: Enter palive=-1, or palive=IP address for PING to keep alive. In which, -1 means to disable the function. If an IP address is specified here, it means to enable PING to the IP address.</p>
--------------------------------------	--

For Dial-Out Settings

<p><index> <ctype=> <dialto=> <ltype=> <oname=> <opwd=> <pauth=> <ovj=> <okey=> <ometh=> <sch=> <ikemode=> <ikeid=></p>	<p><index>: Enter the index number of L2L (LAN to LAN) profile.</p> <p><ctype=>: Enter ctype=t, ctype=s, ctype=l, ctype=l1 or ctype=l2 to set "Type of Server I am calling".</p> <p>t, PPTP s, IPsec. l, L2TP(IPsec Policy None). l1, L2TP(IPsec Policy Nice to Have). l2, L2TP(IPsec Policy Must).</p> <p><dialto=>: Enter dialto=IP address or dialto=Host Name for VPN (such as dialto=draytek.com or dialto=123.45.67.89).</p> <p><ltype=>: Enter ltype=0, ltype=1, ltype=2 or ltype=3 to specify Link Type.</p> <p>0, disable 1, 64kbps 2, 128kbps 3, BOD</p> <p><oname=>: Enter oname=dial-out username (e.g., oname=admin).</p> <p><opwd=>: Enter opwd=dial-out password (e.g., opwd=1234).</p> <p><pauth=>: Enter pauth=pc or pauth=p to set PPP authentication. In which, pc means PAP&CHAP, p means AP Only.</p> <p><ovj=>: Enter ovj=on or ovj=off to enable/disable VJ Compression.</p> <p><okey=>: Enter okey=IKE Pre-Shared Key to set the PSK (e.g., okey=abcd).</p> <p><ometh=>: see below</p> <p>Enter ometh=ah a/m/s/S (means AH Auto, AH MD5, AH SHA1, or AH SHA2).</p> <p>Enter ometh=espd a/m/s/S or ometh=espda a/m/s/S (means ESP DES without or with Authentication Auto/MD5/ SHA1/ SHA2).</p> <p>Enter ometh=esp3 or ometh=esp3a a/m/s/S (means ESP 3DES without or with Authentication Auto /</p>
--	---

	<p>MD5/ SHA1/ SHA2).</p> <p>Enter ometh=espa 1/9/2 or ometh=espa a/m/s/S 1/9/2. (means ESP AES 128/192/256 without or with Authentication Auto/MD5/SHA1/SHA2 (AES128/192/256))</p> <p><sch=>: Enter sch=1 ~ 15 to select schedule 1 ~ 15. (e.g., sch=1,3,5,7 Set schedule 1->3->5->7)</p> <p><ikemode=>: Enter ikemode=m or ikemode=a to set IKE phase 1 mode as Main or Aggressive mode.</p> <p><ikeid=>: Enter ikeid=local ID to set IKE local ID (e.g., ikeid=vigor).</p>
--	---

For Dial-In Settings

<p><index> <itype=> <peer=> <peerid=> <iname=> <ipwd=> <ivj=> <ikey=> <imeth=></p>	<p><index>: Enter the index number of L2L (LAN to LAN) profile.</p> <p><itype=>: see below</p> <p>Enter itype=t (for PPTP)</p> <p>Enter itype=s (for IPsec)</p> <p>Enter itype=l (for L2TP(IPsec Policy None))</p> <p>Enter itype=l1 (for L2TP(IPsec Policy Nice to Have))</p> <p>Enter itype=l2 (for L2TP(IPsec Policy Must))</p> <p>Enter itype=c (for SSL Tunnel)</p> <p><peer=>: Enter peer=off or peer=IP address. In which, "off" means any remote IP is allowed to dial in. "IP address" means to allow VPN dial-in with a specified IP address (e.g., 203.12.23.48).</p> <p><peerid=>: Enter peerid=ID name as the peer ID for remote VPN gateway. For example, peerid=draytek means the word "draytek" is used as the local ID.</p> <p><iname=>: Enter iname=name as the dial-in username. For example, iname=admin means the word "admin" is used as the username.</p> <p><ipwd>: Enter ipwd=password as the dial-in password. For example, ipwd=1234 means the word "1234" is used as the password.</p> <p><ivj>: Enter ivj=on or ivj=off to enable or disable the function of VJ Compression.</p> <p><ikey>: Enter ikey=ikey as the IKE Pre-Shared Key. For example, ikey=abcd means the word "abcd" is used as the IKE PSK.</p> <p><imeth=>: Enter imeth=h, d, 3, a to specify the IPsec security method.</p> <ul style="list-style-type: none"> d, Allow AH d, Allow DES 3, Allow 3DES a, Allow AES
--	---

For TCP/IP Settings

<p><index> <mywip=> <rgip=> <rnip=> <rnmask=> <lnip=> <lnmask=> <rip=> <mode=> <droute=></p>	<p><index>: Enter the index number of L2L (LAN to LAN) profile.</p> <p><mywip=>: Enter mywip=IP address to set MY WAN IP. For example, mywip=1.2.3.4 means the IP address "1.2.3.4" is used as My WAN IP.</p> <p><rgip=>: Enter rgip= IP address to set the Remote Gateway IP. For example, rgip=2.3.4.5 means the IP address "2.3.4.5" is used as the Remote Gateway IP.</p> <p><rnip=>: Enter rnip= IP address to set the Remote Network IP.</p>
--	--

For example, rnip=4.5.6.7 means the IP address "4.5.6.7" is used as the Remote Network IP.

<rnmask=>: Enter rnmask=mask address to set the Remote Network Mask. For example, rnmask=255.255.255.0 means the mask address "255.255.255.0" is used as the Remote Network Mask.

<lnip=>: Enter lnip=IP address to set the Local Network IP. For example, lnip=1.2.3.4 means the IP address "1.2.3.4" is used as the Local Network IP.

<lnmask=>: Enter lnmask=mask address to set the Local Network Mask. For example, lnmask=255.255.255.200 means the mask address "255.255.255.00" is used as the Local Network Mask.

<rip=>: Enter rip=d, t, r or b to set RIP Direction.

- d, Disable
- t, TX
- r, RX
- b, Both

<mode=>: Enter mode=r or mode=n.

- mode=r means to set Route mode for the option of "From first subnet to remote network, you have to do".
- mode=n means to set NAT mode for the option of "From first subnet to remote network, you have to do".

<droute=>: Enter droute=off or droute=on for the option of "Change default route to this VPN tunnel (Only single WAN supports this)".

- droute=on means to enable the function.
- droute=off means to disable the function.

Example

```

> vpn option 1 idle=250
% Change Log..
% Idle Timeout = 250
> vpn option 1 itype=t,s,l2 peer=192.168.1.54 peerid=mary iname=usercarrie ipwd=12345678 ivj=on ikey=abcd imeth=h
% Change Log..

% Allowed Dial-In Type : PPTP IPsec L2TP(Must)
% Allow dial from (IP) : 192.168.1.54
% Allow dial from (peer id): mary
% Dial-in Username = usercarrie
% Password : 12345678
% VJ Compression (dial-in) = on
% Pre-share Key (dial-in): abcd
% Dial-in IPsec Security Method: AH
>

```

Telnet Command: vpn mroute

This command allows users to list, add or delete static routes for a certain LAN to LAN VPN profile.

Syntax

vpn mroute <index> list

vpn mroute <index> add <network ip>/<mask>

vpn mroute <index> del <network ip>/<mask>

Syntax Description

Parameter	Description
<index> list	It means to display the route settings. <index>: Enter an index number (1 ~ 32) of the VPN profile.
<index> add <network ip>/<mask>	It means to add a new route. <index>: Enter an index number (1 ~ 32) of the VPN profile. <network ip>/<mask>: Enter the IP address with the network mask address (e.g., 192.168.3.5/24).
<index> del <network ip>/<mask>	It means to delete specified route. <index>: Enter an index number (1 ~ 32) of the VPN profile. <network ip>/<mask>: Enter the IP address with the network mask address (e.g., 192.168.3.5/24).

Example

```
> vpn mroute 1 add 192.168.5.0/24
% 192.168.5.0/24
% Add new route 192.168.5.0/24 to profile 1
```

Telnet Command: vpn list

This command allows users to view LAN to LAN VPN profiles.

Syntax

vpn list <index> all

vpn list <index> com

vpn list <index> out

vpn list <index> in

vpn list <index> net

Syntax Description

Parameter	Description
<index> all	It means to list configuration of the specified profile. <index>: Enter an index number (1 ~ 32) of the VPN profile.
<index> com	It means to list common settings of the specified profile. <index>: Enter an index number (1 ~ 32) of the VPN profile.
<index> out	It means to list dial-out settings of the specified profile. <index>: Enter an index number (1 ~ 32) of the VPN profile.
<index> in	It means to list dial-in settings of the specified profile. <index>: Enter an index number (1 ~ 32) of the VPN profile.
<index> net	It means to list Network Settings of the specified profile. <index>: Enter an index number (1 ~ 32) of the VPN profile.

Example

```

> rayrouter> vpn list 1 all
Common Settings

Profile Name          : name1
Profile Status       : Enable
VPN Connection Through : WAN1 First
Dialout WAN IP Alias Index : None
Netbios Naming Packet : Pass
Call Direction       : Dial-In
Idle Timeout         : 300
PING to keep alive   : off

Dial-out Settings

Type of Server       : ISDN
Link Type:           : 64k bps
Username             : ???
Password             :
PPP Authentication   : PAP/CHAP
VJ Compression       : on
Pre-Shared Key       :
IPsec Security Method : AH
Schedule             : 0,0,0,0
Remote Callback      : off
Provide ISDN Number  : off
IKE phase 1 mode     : Main mode
IKE Local ID         :

Dial-In Settings
...

```

Telnet Command: vpn remote

This command allows users to enable or disable *PPTP/IPsec/L2TP* VPN service.

Syntax

```
vpn remote <PPTP/IPsec/L2TP/SSLVPN> <on/off>
```

Syntax Description

Parameter	Description
<PPTP/IPsec/L2TP/SSLVPN> <on/off>	<PPTP/IPsec/L2TP/SSLVPN>: There are four types to be selected. Enter PPTP, IPsec, L2TP or SSLVPN. <on/off>: Enter on or off. on - enable VPN remote setting. off - disable VPN remote setting.

Example

```

> vpn remote PPTP on
Set PPTP VPN Service : On

Please restart the router!!

```

Telnet Command: vpn 2ndsubnet

This command allows users to enable second subnet IP as VPN server IP.

Syntax

vpn 2ndsubnet <on/off>

Syntax Description

Parameter	Description
<on/off>	<on/off>: Enter on or off. on: enable or disable second subnet. off: disable the second subnet.

Example

```
> vpn 2ndsubnet on
%Enable second subnet IP as VPN server IP!
```

Telnet Command: vpn NetBios

This command allows users to enable or disable NetBios for Remote Access User Accounts or LAN-to-LAN Profile.

Syntax

vpn NetBios set <H2I/L2I> <index> <Block/Pass>

Syntax Description

Parameter	Description
<H2I/L2I> <index> <Block/Pass>	<H2I/L2I>: Enter H2I or L2L. Specify which one will be applied by NetBios. H2I, means Remote Access User Accounts. L2I, means LAN-to-LAN Profile. <index>: Enter an index number of the profile. <Block/Pass>: Enter Pass or Block. Pass - Have an inquiry for data transmission between the hosts located on both sides of VPN Tunnel while connecting. Block - When there is conflict occurred between the hosts on both sides of VPN Tunnel in connecting, set it block data transmission of Netbios Naming Packet inside the tunnel.

Example

```
> vpn NetBios set H2I 1 Pass
% Remote Dial In Profile Index [1] :
% NetBios Block/Pass: [PASS]
```

Telnet Command: vpn mss

This command allows users to configure the maximum segment size (MSS) for different TCP types.

Syntax

vpn mss show

vpn mss default

vpn mss set <connection type> <TCP maximum segment size range>

Syntax Description

Parameter	Description
<i>show</i>	It means to display current setting status.
<i>default</i>	TCP maximum segment size for all the VPN connection will be set as 1360 bytes.
<i>set</i>	Use it to specify the connection type and value of MSS.
<i><connection type></i> <TCP maximum segment size range>	<connection type>: Enter 1, 2, 3, 4 or 5. 1, PPTP 2, L2TP 3, IPsec 4, L2TP over IPsec 5, SSL Tunnel <TCP maximum segment size range>: Enter a value. Each type has different segment size range. PPTP, 1 ~ 1412 L2TP, 1 ~ 1408 IPsec, 1 ~ 1381 L2TP over IPsec, 1 ~ 1361 SSL Tunnel, 1 ~ 1360

Example

```
> vpn mss set 1 1400
% VPN TCP maximum segment size (MSS) :
  PPTP = 1400
  L2TP = 1360
  IPsec = 1360
  L2TP over IPsec = 1360
  SSL Tunnel = Not yet setting!
```

Telnet Command: vpn ike

This command is used to display IKE memory status and leakage list.

Syntax

vpn ike -q

vpn ike -s

vpn ike v2

vpn ike v2 debug <on/off>

Syntax Description

Parameter	Description
-q	Display IKE memory status and leakage list.
-s	Display IPsec state list.
V2 debug <on/off>	It is used for RD debug.

Example

```
> vpn ike -q
IKE Memory Status and Leakage List

# of free L-Buffer=95, minimum=94, leak=1
# of free M-Buffer=529, minimum=529 leak=3
# of free S-Buffer=1199, minimum=1198, leak=1
# of free Msgid-Buffer=1024, minimum=1024
```

Telnet Command: vpn Multicast

This command allows users to pass or block the multi-cast packet via VPN.

Syntax

vpn Multicast set <H2L/L2L> <index> <Block/Pass>

Syntax Description

Parameter	Description
<H2L/L2L> <index> <Block/Pass>	<H2L/L2L>: Enter H2L or L2L. Specify which one will be applied for multi-cast packets. H2L, means Host to LAN (Remote Access User Accounts). L2L, means LAN-to-LAN Profile. <index>: Enter an index number of the profile. <Block/Pass>: Enter Pass or Block the Multicast Packets..

Example

```
> vpn Multicast set L2L 1 Pass
% Lan to Lan Profile Index [1] :
% Status Block/Pass: [PASS]
```

Telnet Command: vpn pass2nd

This command allows users to determine if the packets coming from the second subnet passing through current used VPN tunnel.

Syntax

vpn pass2nd <on/off>

Syntax Description

Parameter	Description
<on/off>	<on/off>: Enter on or off.

	on - the second subnet is allowed to pass VPN tunnel. off -the second subnet is not allowed to pass VPN tunnel.
--	--

Example

```
> vpn pass2nd on
% 2nd subnet is allowed to pass VPN tunnel!
```

Telnet Command: vpn pass2nat

This command allows users to determine if the packets passing through by NAT or not when the VPN tunnel disconnects.

Syntax

vpn pass2nat <on/off>

Syntax Description

Parameter	Description
<on/off>	<on/off>: Enter on or off. on - the packets can pass through NAT. off - the packets cannot pass through NAT.

Example

```
> vpn pass2nat on
% Packets would go through by NAT when VPN disconnect!!
```

Telnet Command: vpn sameSubnet

This command allows users to build VPN between clients via virtual subnet.

```
vpn sameSubnet -I <value>
vpn sameSubnet -E <0/1>
vpn sameSubnet -e <value>
vpn sameSubnet -I <IP address>
vpn sameSubnet -o <add/del>
vpn sameSubnet -v
```

Syntax Description

Parameter	Description
-I <value>	It means to specify the index number of VPN profile. <value>: Enter the index number of the VPN profile.
-E <0/1>	It means to enable / disable the IpsecWithSameSubnet. <0/1>: Enter 0 or 1. 0: Disable 1: Enable.
-e <value>	It means to translate LAN subnet to virtual subnet. <value>: Enter 1, 2 1: LAN1 2: LAN2
-I <IP address>	Set the IP address as the virtual subnet.
-o <add/del>	Specify the operation to be performed. <add/del>: Enter add or del.
-v	View the current settings. However, only the enabled profile will be viewed.

Example

```
> vpn sameS -i 1 -e 1 -E 1 -e 1 -I 10.10.10.0 -o add
> vpn sameS -v
IPsec with the same subnet:
VPN profile 1 enable,
% translated LAN1 to Virtual subnet: 10.10.10.0
```

Telnet Command: wan ppp_mru

This command allows users to adjust the size of PPP LCP MRU. It is used for specific network.

Syntax

```
wan ppp_mru <WAN interface number> <MRU size >
```

Syntax Description

Parameter	Description
<WAN interface number> <MRU size>	<WAN interface number>: Enter a number (1 ~5) to represent the physical interface. (1 means WAN1, 2 means WAN2, ...)

<MRU size>: Enter a value (1400 ~ 1600) to set the number of PPP LCP MRU.

Example

```
>wan ppp_mru 1 ?
% Now: 1492

> wan ppp_mru 1 1490
>
> wan ppp_mru 1 ?
% Now: 1490

> wan ppp_mru 1 1492
> wan ppp_mru 1 ?
% Now: 1492
```

Telnet Command: wan mtu

This command allows users to adjust the size of MTU for WAN1.

Syntax

wan mtu <value>

Syntax Description

Parameter	Description
<value>	It means the number of MTU for PPP. The available range is from 1000 to 1500. For Static IP/DHCP, the maximum number will be 1500. For PPPoE, the maximum number will be 1492. For PPTP/L2TP, the maximum number will be 1460.

Example

```
> wan mtu 1100
> wan mtu ?
Static IP/DHCP (Max MSS: 1500)
PPPoE(Max MSS: 1492)
PPTP/L2TP(Max MSS: 1460)
% wan ppp_mss <MSS size: 1000 ~ 1500>
% Now: 1100
```

Telnet Command: wan dns

This command allows you to configure the DNS server.

Syntax

wan dns <wan_no> <dns_select> <ipv4_addr>

Syntax Description

Parameter	Description
<wan_no> <dns_select> <ipv4_addr>	<wan_no>: Enter 1 or 2. It means to indicate the WAN interface. 1, WAN1 2, WAN2 <dns_select>: Enter pri or sec.

	pri, primary DNS sec, secondary DNS <ipv4_addr>: Enter the IPv4 address for the DNS server.
--	---

Example

```
> wan dns 1 pri 192.168.1.126
% Set WAN1 primary DNS done.
% Now: 192.168.1.126
```

Telnet Command: wan DF_check

This command allows you to enable or disable the function of DF (Don't fragment)

Syntax

wan DF_check <on/off>

Syntax Description

Parameter	Description
<on/off>	<on/off>: Enter on or off. on, enable DF. off, disable DF.

Example

```
> wan DF_check on
%DF bit check enable!
> wan DF_check off
%DF bit check disable (reset DF bit)!
```

Telnet Command: wan disable

This command allows you to disable WAN connection.

Example

```
> wan disable WAN
%WAN disabled.
```

Telnet Command: wan enable

This command allows you to disable wan connection.

Example

```
> wan enable WAN
%WAN1 enabled.
```

Telnet Command: wan forward

This command allows you to enable or disable the function of WAN forwarding. The packets are allowed to be transmitted between different WANs.

Syntax

wan forward <on/off>

Syntax Description

Parameter	Description
<on/off>	<on/off>: Enter on or off. on, enable WAN forward. off, disable WAN forward.

Example

```
> wan forward ?
%WAN forwarding is Disable!

> wan forward on
%WAN forwarding is enable!
```

Telnet Command: wan status

This command allows you to display the status of WAN connection, including connection mode, TX/RX packets, DNS settings and IP address.

Example

```
> wan status
WAN1: Offline, stall=Y
Mode: ---, Up Time=00:00:00
IP----, GW IP----
TX Packets=0, TX Rate(bps)=0, RX Packets=0, RX Rate(bps)=0
Primary DNS=0.0.0.0, Secondary DNS=0.0.0.0

WAN2: Offline, stall=N
Mode: ---, Up Time=00:00:00
IP----, GW IP----
TX Packets=0, TX Rate(bps)=0, RX Packets=0, RX Rate(bps)=0
Primary DNS=0.0.0.0, Secondary DNS=0.0.0.0

PVC_WAN3: Offline, stall=N
Mode: ---, Up Time=00:00:00
IP----, GW IP----
TX Packets=0, TX Rate(bps)=0, RX Packets=0, RX Rate(bps)=0
Primary DNS=0.0.0.0, Secondary DNS=0.0.0.0

PVC_WAN4: Offline, stall=N
Mode: ---, Up Time=00:00:00
IP----, GW IP----
TX Packets=0, TX Rate(bps)=0, RX Packets=0, RX Rate(bps)=0
Primary DNS=0.0.0.0, Secondary DNS=0.0.0.0

PVC_WAN5: Offline, stall=N

Mode: ---, Up Time=00:00:00
IP----, GW IP----
TX Packets=0, TX Rate(bps)=0, RX Packets=0, RX Rate(bps)=0

PVC_WAN6: Offline, stall=N

Mode: ---, Up Time=00:00:00
IP----, GW IP----
TX Packets=0, TX Rate(bps)=0, RX Packets=0, RX Rate(bps)=0

PVC_WAN7: Offline, stall=N

Mode: ---, Up Time=00:00:00
IP----, GW IP----
TX Packets=0, TX Rate(bps)=0, RX Packets=0, RX Rate(bps)=0
```

Telnet Command: wan detect

This command allows you to configure WAN connection detection. When Ping Detection is enabled (for Static IP or PPPoE mode), Router pings specified IP addresses to detect the WAN connection.

Syntax

```

wan detect <wan1> <on/off/always_on>
wan detect <wan1> <off> -t <time>
wan detect <wan1> <off> -i <Interval>
wan detect <wan1> target <ip addr>
wan detect <wan1> ttl <1-255>
wan detect <wan1> target2 <ip addr>
wan detect <wan1> target_gw <1/0>
wan detect <wan1> interval <interval>
wan detect <wan1> retry <retry>
wan detect status
  
```

Syntax Description

Parameter	Description
<wan1> <on/off/always_on>	<wan1>: Enter wan1 to specify WAN1. <on/off/always_on>: Enter on, off, or always_on. On, enable ping detection. Off, enable the ARP detection. Always_on, disable the link detection. The connection is always on.
<wan1> <off> -t <time>	<wan1>: Enter wan1 to specify WAN1. <off>: Enter off. <time>: Enter a time value. The default value is "30" and the range shall be 1 to 255.
<wan1> <off> -i <Interval>	<wan1>: Enter wan1 to specify WAN1. <off>: Enter off. <interval>: Enter a value. It is the interval for the system to execute the PING operation. The default value is "5" and it shall be smaller than time setting.
<wan1> target <ip addr>	<wan1>: Enter wan1 to specify WAN1. <ip addr>: Enter an IP address as the ping target.
<wan1> ttl <1-255>	<wan1>: Enter wan1 to specify WAN1. <1-255>: It means to set the ping TTL value (work as trace route) If you do not set any value for ttl here or just type 0 here, the system will use default setting (255) as the ttl value.
<wan1> target2 <ip addr>	<wan1>: Enter wan1 to specify WAN1. <ip addr>: Enter an IP address as the the secondary ping target.
<wan1> target_gw <1/0>	<wan1>: Enter wan1 to specify WAN1. <1/0>: Enter 1 or 0 to set whether to use gateway as ping

	target. (1, yes; 0, no) Note that USB WAN (PPP mode) cannot support PING gateway
<i><wan1> interval<Interval></i>	<i><wan1></i> : Enter wan1 to specify WAN1. <i><interval></i> : Enter a value to set the interval between each ping operation. Available setting is between 1 and 3600. The unit is second.
<i><wan1> retry <retry></i>	<i><wan1></i> : Enter wan1 to specify WAN1. <i><retry></i> : Enter a number to set how many ping operations are retried before the Router judges that the WAN connection is disconnected. Available setting is between 1 and 255. The unit is times.
<i>status</i>	It means to show the current status.

Example

```
> wan detect status
WAN1: off, send time=30, Interval = 5
WAN2: off, send time=30, Interval = 5
WAN3: off, send time=30, Interval = 5
WAN4: off, send time=30, Interval = 5
WAN5: off, send time=30, Interval = 5
WAN6: off, send time=30, Interval = 5>
```

Telnet Command: wan mvlan

This command allows you to configure multi-VLAN for WAN and LAN. It supports pure bridge mode (modem mode) between Ethernet WAN and LAN port 2~4.

Syntax

wan mvlan <pvc_no/status/save/enable/disable> <on/off/clear/tag tag_no> <service type/vlan priority> <px ... >

wan mvlan kepttag <pvc_no><on/off>

Syntax Description

Parameter	Description
<i><pvc_no/status/save/enable/disable> <on/off/clear/tag tag_no> <service type/vlan priority> <px ... ></i>	<i><pvc_no/status/save/enable/disable></i> : see below, <i><pvc_no></i> : Enter the index number of PVC. It means index number of PVC. There are 8 PVC, 0(Channel-1) to 7(Channel-8) allowed to be configured. However, bridge mode can be set on PVC number 2 to 7. <i><status></i> : Enter status to display the whole Bridge status. <i><save></i> : Enter save to save the configuration into flash of Vigor router. <i><enable></i> : Enter enable for enabling the Multi-VLAN function. <i><disable></i> : Enter disable for disabling the Multi-VLAN function. <i><on/off/clear/tag tag_no></i> : see below. <i><on></i> : Enter on to turn on bridge mode for the specific channel. <i><off></i> : Enter off to turn off bridge mode for the specific

	<p>channel.</p> <p><clear>: Enter clear to clear the port setting.</p> <p><tag tag_no>: Enter a tag number (-1, 1~4095) for VLAN (e.g, tag -1, tag 100, and etc.)</p> <p><service type/vlan priority>: Enter 0 or 1 (for service type, 0 for Normal, 1 for IGMP), or enter a value (0~7) for VLAN priority.</p> <p><px ... >: Enter 2, 3 or 4. It means LAN port. Available setting number is from 2 to 4. Port number 1 is locked for NAT usage.</p>
<i>keep tag</i>	It means Multi-VLAN packets will keep their VLAN headers to LAN.

Example

```

> wan mvlan 7 on p2
PVC Bridge p1 p2 Service Type Tag Priority
-----
7 OFF 0 0 Normal 0(OFF) 0
>

```

Telnet Command: wan multifno

This command allows you to specify a channel (in Multi-PVC/VLAN) to make bridge connection to a specified WAN interface.

Syntax

`wan multifno <channel #> <WAN interface #>`

`wan multifno status`

Syntax Description

Parameter	Description
<code><channel #> <WAN interface #></code>	<p><channel #>: Enter channel 5, channel 6, channel 7 or channel 8.</p> <p><WAN interface #>: Enter 1 or 2 to indicate the WAN interface.</p> <p>1, WAN1</p> <p>2, WAN2</p>
<code>status</code>	It means to display current bridge status.

Example

```

> wan multifno 5 1
% Configured channel 5 uplink to WAN1
> wan multifno status
% Channel 5 uplink ifno: 3
% Channel 6 uplink ifno: 3
% Channel 7 uplink ifno: 3
>

```

Telnet Command: wan vlan

This command allows you to configure the VLAN tag of WAN1.

Syntax

`wan vlan wan <#> tag <value>`

```
wan vlan wan <#> <enable/disable>
wan vlan wan <#> pri <value>
wan vlan stat
```

Syntax Description

Parameter	Description
<i>wan <#> tag <value></i>	Specify which WAN interface will be tagged. <#>: Enter 1 for WAN1. tag: Type a number for tagging on WAN interface. <value>: Enter a number.
<i>wan <#> <enable/disable></i>	<#>: Enter 1 for WAN1. <enable/disable>: Enter enable or disable. Enable: Specified WAN interface will be tagged. Disable: Disable the function of tagging on WAN interface.
<i>wan <#> pri <value></i>	It means the priority for such VLAN. <#>: Enter 1 for WAN1. <value>: Enter 0 ~ 7.
<i>stat</i>	Display current VLAN status.

Example

```
> wan vlan stat
Interface      Pri      Tag      Enabled
=====
WAN1 (ADSL)   0        0
```

Telnet Command: wan detect_mtu

This command allows you to run a WAN MTU Discovery. The user can specify an IPv4 target to ping and find the suitable MTU size of the WAN interface.

Syntax

```
wan detect_mtu -i <Host/IP address> -s <mtu_size> -d <decrease size> -w <1> -c <1-10>
```

Syntax Description

Parameter	Description
<i>-i <Host/IP address> -s <mtu_size> -d <decrease size> -w <1> -c <1-10></i>	-i <Host/IP address>: Enter the IP address/domain name of the target to detect. -s <mtu_size>: Enter a value (1000 ~ 1500) as the MTU size you want to start to decrease. -d <decrease size>: Enter a value (1 ~ 100) as the MTU size to decrease between detections. -w <1>: Enter 1 to specify WAN1. -c <1-10>: Enter a value (1-10) to set the times to send the ping packets out. Default value is 3.

Example

```
> wan detect_mtu -w 1 -i 8.8.8.8 -s 1500 -d 30 -c 10
detecting mtu size:1500!!!

mtu size:1470!!!
```

Telnet Command: wan detect_mtu6

This command allows you to run a WAN MTU Discovery. The user can specify an IPv6 target to ping and find the suitable MTU size of the WAN interface.

Syntax

```
wan detect_mtu6 -i <Host/IP address> -s <mtu_size> -w <1>
```

Syntax Description

Parameter	Description
<i>-i <Host/IP address> -s <mtu_size> -w <1></i>	<i>-i <Host/IP address></i> : Enter the IPv6 address/domain name of the target to detect. <i>-s <mtu_size></i> : Enter a value (1280 ~ 1500) as the MTU size you want to start to decrease. <i>-w <1></i> : Enter 1 to specify WAN1.

Example

```
> wan detect_mtu6 -w 2 -i 2404:6800:4008:c06::5e -s 1500  
>
```

Telnet Command: wl acl

This command allows the user to configure wireless access control settings.

Syntax

```
wl acl enable <ssid1 ssid2 ssid3 ssid4>  
wl acl disable <ssid1 ssid2 ssid3 ssid4>  
wl acl add <MAC> <ssid1 ssid2 ssid3 ssid4> <comment> <isolate>  
wl acl del <MAC>  
wl acl mode <ssid1 ssid2 ssid3 ssid4> <white/black>  
wl acl show  
wl acl showmode  
wl acl clear
```

Syntax Description

Parameter	Description
<i>enable <ssid1 ssid2 ssid3 ssid4></i>	<i><ssid1 ssid2 ssid3 ssid4></i> : Enter ssid1, ssid2, ssid3, or ssid4 to enable the settings for SSID1, SSID2, SSID3 or SSID4.
<i>disable <ssid1 ssid2 ssid3 ssid4></i>	<i><ssid1 ssid2 ssid3 ssid4></i> : Enter ssid1, ssid2, ssid3, or ssid4 to disable the settings for SSID1, SSID2, SSID3 or SSID4.
<i>add <MAC> <ssid1 ssid2 ssid3 ssid4> <comment> <isolate></i>	It means to associate a MAC address to certain SSID interfaces' access control settings. The isolate setting will limit the wireless client's network capabilities to accessing the wireless LAN only. [MAC] format: xx-xx-xx-xx-xx-xx or xx:xx:xx:xx:xx:xx or xx.xx.xx.xx.xx.xx <i><MAC></i> : Enter a MAC address.

	<p><ssid1 ssid2 ssid3 ssid4>: Enter ssid1, ssid2, ssid3, or ssid4 to select SSID1, SSID2, SSID3 or SSID4.</p> <p><comment>: Enter a brief decription.</p> <p><isolate>: Enter isolate.</p>
<i>del</i> <MAC>	<p>It means to delete a MAC address entry defined in the access control list.</p> <p><MAC>: Enter a MAC address.</p>
<i>mode</i> <ssid1 ssid2 ssid3 ssid4> <white/black>	<p>It means to set white/black list for each SSID.</p> <p><ssid1 ssid2 ssid3 ssid4>: Enter ssid1, ssid2, ssid3, or ssid4 to select SSID1, SSID2, SSID3 or SSID4.</p> <p><white/black>: Enter white or black.</p>
<i>wl acl show</i>	It means to show access control status.
<i>wl acl showmode</i>	It means to show the mode for each SSID.
<i>wl acl clean</i>	It means to clean all access control setting.

Example

```

> wl acl add 00-1D-AA-93-9F-3C ssid1 test isolate
Set Done !!
> wl acl show
-----Mac Address Filter Status-----
SSID1: Disable
SSID2: Disable
SSID3: Disable
SSID4: Disable

-----MAC Address List-----
Index   Attribute   MAC Address       Associated SSIDs   Comment
  1      s           00:1d:aa:93:9f:3c  SSID1             test

s: Isolate the station from LAN
> wl acl showmode
SSID1: None
SSID2: None
SSID3: None
SSID4: None
>

```

Telnet Command: *wl config*

This command allows users to configure general settings and security settings for wireless connection.

Syntax

wl config mode <value>

wl config mode show

wl config channel <number>

wl config preamble <enable>

wl config txburst <enable>

wl config ssid <ssid_num><enable> <ssid_name> <hidden_ssid>

wl config security <SSID_NUMBER> <mode>

```

wl config ratectl <ssid_num><enable> <upload download>
wl config isolate <ssid_num> <lan member>
wl config dtim <value>
wl config beaconperiod <value>
wl config radio <enable>
wl config frag <value>
wl config rts <value>
wl config rate_alg <value>
wl config country <value>

```

Syntax Description

Parameter	Description
<i>mode</i> <value>	It means to select connection mode for wireless connection. <value>: Enter 11bg, 11gn, 11bgn, 11n, 11g or 11b to set connection mode for wireless connection.
<i>mode show</i>	It means to display what the current wireless mode is.
<i>channel</i> <number>	It means the channel of frequency of the wireless LAN. <number>: Enter 0,1,2,3,4,5,6,7,8,9,10,11,12 or 13. number=0, means Auto number=1, means Channel 1 number=13, means Channel 13.
<i>preamble</i> <enable>	It means to define the length of the sync field in an 802.11 packet. Most modern wireless network uses short preamble with 56 bit sync field instead of long preamble with 128 bit sync field. However, some original 11b wireless network devices only support long preamble. <enable>: Enter 0 or 1. 0, disable to use long preamble. 1, enable to use long preamble.
<i>txburst</i> <enable>	It means to enhance the performance in data transmission about 40%* more (by enabling Tx Burst). It is active only when both sides of Access Point and Station (in wireless client) invoke this function at the same time. <enable>: Enter 0 or 1. 0, disable the function. 1, enable the function.
<i>ssid</i> <ssid_num> <enable> <ssid_name> <hidden_ssid>	It means to set the name of the SSID, hide the SSID if required. <ssid_num>: Enter 1, 2, 3 or 4 to specify SSID1, SSID2, SSID3 or SSID4. <enable>: Enter 1 or 0. 1, enable; 0, disable. <ssid_name>: Enter a name for the specified SSID. <hidden_ssid>: Enter 0 to hide the SSID or 1 to display the SSID
<i>security</i> <SSID_NUMBER>	It means to configure security settings for the wireless

<i><mode><key><index></i>	<p>connection.</p> <p><SSID_NUMBER>: Enter 1, 2, 3 or 4 to specify SSID1, SSID2, SSID3 or SSID4.</p> <p><mode>: Available settings are:</p> <ul style="list-style-type: none"> disable: No security. wpa1x: WPA/802.1x Only wpa21x: WPA2/802.1x Only wpamix1x: Mixed (WPA+WPA2/802.1x only) wep1x: WEP/802.1x Only wpapsk: WPA/PSK wpa2psk: WPA2/PSK wpamixpsk: Mixed (WPA+WPA2)/PSK wep: WEP <p><key>: Enter a string. You have to add keys for <i>wpapsk</i>, <i>wpa2psk</i>, <i>wpamixpsk</i> and <i>wep</i>, and specify index number of schedule profiles to be followed by the wireless connection. WEP keys must be in 5/13 ASCII text string or 10/26 Hexadecimal digit format; WPA keys must be in 8-63 ASCII text string or 64 Hexadecimal digit format.</p> <p><index>: Enter an index number.</p>
<i>ratectl</i> <i><ssid_num><enable></i> <i><upload download></i>	<p>It means to set the rate control for the specified SSID.</p> <p><ssid_num>: Enter 1, 2, 3 or 4 to specify SSID1, SSID2, SSID3 or SSID4.</p> <p><enable>: Enter 0 or 1. It means to enable the function of the rate control for the specified SSID. 0: disable and 1:enable.</p> <p><upload>: Enter a value. It means to configure the rate control for data upload. The unit is kbps.</p> <p><download>: Enter a value. It means to configure the rate control for data download. The unit is kbps.</p>
<i>Isolate <ssid_num> <lan member></i>	<p>It means to isolate the wireless connection for LAN and/or Member.</p> <p><ssid_num>: Enter 1, 2, 3 or 4 to specify SSID1, SSID2, SSID3 or SSID4.</p> <p><lan> - It can make the wireless clients (stations) with remote-dial and LAN to LAN users not accessing for each other. Enter 1 to enable, or 0 to disable.</p> <p><member> - It can make the wireless clients (stations) with the same SSID not accessing for each other. Enter 1 to enable, or 0 to disable.</p>
<i>dtim <value></i>	<i><value></i> : Enter a number (1 ~255) to set DTIM.
<i>beaconperiod <value></i>	<i><value></i> : Enter a number (20 ~1023, unit in milli-seonds) as beacon period.
<i>radio <enable></i>	<i><enable></i> : Enter 1 or 0 to enable or disable the wireless radio.
<i>frag <value></i>	<i><value></i> : Enter a number (256 ~2346) to set fragment threshold.
<i>rts <value></i>	<i><value></i> : Enter a number (1 ~2347) to set RTS threshold.
<i>rate_alg <value></i>	<i><value></i> : Enter 0, or 1 to set the version of rate algorithm. 0, old algorithm 1, new algorithm

<i>country</i> <value>	<value>: Enter two capital letters (e.g., TW) to specify the country.
------------------------	---

Example

```

> wl config mode 11bgn
Current mode is 11bgn
% <Note> Please restart wireless after you set the channel
> wl config channel 13
Current channel is 13
% <Note> Please restart wireless after you set the channel.
> wl config preamble 1
Long preamble is enabled
% <Note> Please restart wireless after you set the parameters.
> wl config ssid 1 enable dray
SSID Enable Hide_SSID Name
1 1 0 dray
% <Note> Please restart wireless after you set the parameters.
> wl config security 1 wpa1x
%% Configured Wlan Security Setting:
% SSID1
%% Mode: wpa1x
%% Wireless card must be reset for configurations to take effect
%% (Telnet Command: wl restart)
> wl config isolate 1 1 1

```

Telnet Command: wl set

This command allows users to configure basic wireless settings.

Syntax

`wl set <SSID> <CHAN> <En>`

`wl set txburst <enable>`

Syntax Description

Parameter	Description
<code><SSID> <CHAN> <En></code>	<p><SSID>: Enter a SSID for the router. The maximum character that you can use is 32.</p> <p><CHAN>: Enter a number (1~13) for selecting a channel.</p> <p><En>: Enter on or off.</p> <p>on, enable the function.</p> <p>off, disable the function.</p>
<code>txburst <enable></code>	<p>It means to enhance the performance in data transmission about 40%* more (by enabling <i>Tx Burst</i>). It is active only when both sides of Access Point and Station (in wireless client) invoke this function at the same time.</p> <p><enable>: Enter 0 or 1.</p> <p>0: disable the function.</p> <p>1: enable the function.</p>

Example

```

> wl set MKT 2 on

```

```
% New Wlan Setting is:  
% SSID=MKT  
% Chan=2  
% Wl is Enable
```

Telnet Command: wl act

This command allows users to activate wireless settings.

Syntax

wl act <En>

Syntax Description

Parameter	Description
<En>	It means to enable or disable the function of VPN isolation. <enable>: Enter 0 or 1. 0: diable 1: enable

Example

```
> wl act on  
% Set Wlan to Enable.
```

Telnet Command: wl iso_vpn

This command allows users to activate the function of VPN isolation.

Syntax

```
wl iso_vpn <ssid> <En>
```

Syntax Description

Parameter	Description
<ssid> <En>	<SSID>: Enter 1, 2, 3 or 4 to specify each SSID. 1, SSID1 2, SSID2 3, SSID3 4, SSID4 <En>: Enter 1 or 0 to enable or disable the function of VPN isolation. 0, disable 1, enable

Example

```
> wl iso_vpn 1 on
% ssid: 1 isolate vpn on :1
```

Telnet Command: wl wmm

This command allows users to set WMM for wireless connection. It defines the priority levels for four access categories derived from 802.1d (prioritization tabs).

Syntax

```
wl wmm ap Queldx Aifsn Cwmin Cwmax Txop ACM
wl wmm bss Queldx Aifsn Cwmin Cwmax Txop ACM
wl wmm ack Que0_Ack Que1_Ack Que2_Ack Que3_Ack
wl wmm enable SSID0 SSID1 SSID2 SSID3
wl wmm apsd value
wl wmm show
```

Syntax Description

Parameter	Description
<i>ap Queldx Aifsn Cwmin Cwmax Txop ACM</i>	It means to set WMM for access point. <ul style="list-style-type: none">• <i>Queldx</i> means the number of the queue which the WMM settings will be applied to. There are four queues, best effort, background, voice, and video.• <i>Aifsn</i> controls how long the client waits for each data transmission.• <i>CWMin</i> means contention Window-Min and <i>CWMax</i> means contention Window-Max. Specify the value ranging from 1 to 15.• <i>Txop</i> means transmission opportunity. Specify the value ranging from 0 to 65535.

	<ul style="list-style-type: none"> ACM can restrict stations from using specific category class if it is enabled. <p>Example: <code>wl wmm ap 0 3 4 6 0 0</code></p>
<i>bss QueIdx Aifsn Cwmin Cwmax Txop ACM</i>	<p>It means to set WMM for wireless clients.</p> <ul style="list-style-type: none"> QueIdx means the number of the queue which the WMM settings will be applied to. There are four queues, best effort, background, voice, and video. Aifsn controls how long the client waits for each data transmission. CWMin means contention Window-Min and CWMax means contention Window-Max. Specify the value ranging from 1 to 15. Txop means transmission opportunity. Specify the value ranging from 0 to 65535. ACM can restrict stations from using specific category class if it is enabled. <p>Example: <code>wl wmm bss 0 3 4 10 0 0</code></p>
<i>ack Que0_Ack Que1_Ack Que2_Ack Que3_Ack</i>	<p>It means to map to the Ack policy settings of AP WMM.</p> <p>Example: <code>wl wmm ack 0 0 0 0</code></p>
<i>enable SSID0 SSID1 SSID2 SSID3</i>	<p>It means to enable the WMM for each SSID.</p> <p>0: disable 1: enable</p> <p>Example: <code>wl wmm enable 1 1 1 1</code></p>
<i>Apsd [value]</i>	<p>It means to enable / disable the ASPD(automatic power-save delivery) function.</p> <p>0: disable 1: enable</p> <p>Example: <code>wl wmm apsd 1</code></p>
<i>show</i>	<p>It displays current status of WMM.</p>

Example

```

> wl wmm ap 0 3 4 6 0 0
  QueIdx=0: APAifsn=3,APCwmin=4,APCwmax=6, APTxop=0,APACM=0
> wl wmm show
  Enable WMM: SSID0 =1, SSID1 =1,SSID2 =1,SSID3 =1
  APSD=0
  QueIdx=0: APAifsn=3,APCwmin=4,APCwmax=6, APTxop=0,APACM=0
  QueIdx=1: APAifsn=7,APCwmin=4,APCwmax=10, APTxop=0,APACM=0
  QueIdx=2: APAifsn=1,APCwmin=3,APCwmax=4, APTxop=94,APACM=0
  QueIdx=3: APAifsn=1,APCwmin=2,APCwmax=3, APTxop=47,APACM=0
  QueIdx=0: BSSAifsn=3,BSSCwmin=4,BSSCwmax=10, BSSTxop=0,BSSACM=0
  QueIdx=1: BSSAifsn=7,BSSCwmin=4,BSSCwmax=10, BSSTxop=0,BSSACM=0
  QueIdx=2: BSSAifsn=2,BSSCwmin=3,BSSCwmax=4, BSSTxop=94,BSSACM=0
  QueIdx=3: BSSAifsn=2,BSSCwmin=2,BSSCwmax=3, BSSTxop=47,BSSACM=0
  AckPolicy[0]=0: AckPolicy[1]=0,AckPolicy[2]=0,AckPolicy[3]=0

```

>

Telnet Command: wl ht

This command allows you to configure wireless settings.

Syntax

wl ht bw value

wl ht gi value

wl ht badecline value

wl ht autoba value

wl ht rdg value

wl ht msdu value

wl ht txpower value

wl ht antenna value

wl ht greenfield value

Syntax Description

Parameter	Description
<i>bw value</i>	<value>: Enter 0 or 1. 0 (for BW_20) and 1 (for BW_40).
<i>gi value</i>	<value>: Enter 0 or 1. 0 (for GI_800) and 1 (for GI_4001)
<i>badecline value</i>	<value>: Enter 0 or 1. 0 (for disabling) and 1 (for enabling).
<i>autoba value</i>	<value>: Enter 0 or 1. 0 (for disabling) and 1 (for enabling).
<i>rdg value</i>	<value>: Enter 0 or 1. 0 (for disabling) and 1 (for enabling).
<i>msdu value</i>	<value>: Enter 0 or 1. 0 (for disabling) and 1 (for enabling).
<i>txpower value</i>	<value>: Enter 1 ~ 6 (level).
<i>antenna value</i>	<value>: Enter 0,1,2 or3. 0, 2T3R 1, 2T2R 2, 1T2R 3, 1T1R
<i>greenfield value</i>	<value>: Enter 0 or 1. 0 (for mixed mode) and 1 (for green field).

Example

```
> wl ht bw value 1
  BW=0
  <Note> Please restart wireless after you set new parameters.
> wl restart
  Wireless restart.....
```

Telnet Command: wl restart

This command allows you to restart wireless setting.

Example

```
> wl restart
Wireless restart.....
```

Telnet Command: wl wds

This command allows you to configure WDS settings.

Syntax

wl wds mode <value>

wl wds security <value>

wl wds ap <value>

wl wds hello <value>

wl wds status

wl wds show

wl wds mac add <index addr>

wl wds mac <clear/disable/enable> <index/all>

wl wds flush

Syntax Description

Parameter	Description
<i>mode <value></i>	It means to specify connection mode for WDS. <value>: Enter d, b or r. d, Disable b, Bridge r, Repeater
<i>security <value></i>	It means to configure security mode with encrypted keys for WDS. <value>: Available settings are: disable: No security. wep: WEP wpapsk <key>: WPA/PSK wpa2psk <key>: WPA2/PSK key: Moreover, you have to add keys for <i>wpapsk</i> , <i>wpa2psk</i> , and <i>wep</i> , and specify index number of schedule profiles to be followed by the wireless connection. WEP keys must be in 5/13 ASCII text string or 10/26 Hexadecimal digit format; WPA keys must be in 8-63 ASCII text string or 64 Hexadecimal digit format. e.g., <i>wl dual wds security disable</i> <i>wl dual wds security wep 12345</i> <i>wl dual wds security wpa2psk 12345678</i>
<i>ap <value></i>	It means to enable or disable the AP function. <value>: Enter 1 or 0. 1,- enable the function. 0, disable the function.

<i>hello <value></i>	It means to send hello message to remote end (peer). <value>: Enter 1 or 0. 1, enable the function. 0, disable the function.
<i>status</i>	It means to display WDS link status for 2.4GHz connection.
<i>show</i>	It means to display current WDS settings.
<i>mac add <index addr></i>	add <index addr> -Enter the index number and the MAC address. Add the peer MAC entry in Repeater/Bridge WDS MAC table. e.g., <code>wl wds mac add 1 00:1D:AA:93:9F:3C</code>
<i>mac <clear/disable/enable> <index/all></i>	clear/disable/enable <index/all> - Clear, disable, enable the specified or all MAC entries in Repeater/Bridge WDS MAC table. e.g, <code>wl dual wds mac enable 1</code>
<i>flush</i>	It means to reset all WDS setting.

Example

```
> wl wds status
Please enable WDS hello function first.

> wl wds hello 1
% <Note> Please restart router after you set the parameters.

> wl wds status
```

Telnet Command: wl btnctl

This command allows you to enable or disable wireless button control.

Syntax

`wl btnctl <value>`

Syntax Description

Parameter	Description
<i><value></i>	<value>: Enter 0 or 1. 0, disable 1, enable

Example

```
> wl btnctl 1
Enable wireless botton control
Current wireless botton control is on
>
```

Telnet Command: wl iwpriv and wl ce_cert

These commands are reserved for RD debug. Do not use them.

Telnet Command: wl efuse

This command is used to configure parameters related to wireless RF hardware. At present, it is not allowed for end user to operate.

Telnet Command: wl stalist

This command is used to display the wireless station which accessing Internet via Vigor router.

Syntax

`wl stalist show`

`wl stalist num`

Syntax Description

Parameter	Description
<code>show</code>	Display the station list.
<code>num</code>	Display the number of wireless station.

Example

```
> wl stalist show
2.4G Wireless Station List :

Index  Status  IP Address      MAC Address      Associated with

Status Codes :
C: Connected, No encryption.
E: Connected, WEP.
P: Connected, WPA.
A: Connected, WPA2.
B: Blocked by Access Control.
N: Connecting.
F: Fail to pass WPA/PSK authentication.
```

Telnet Command: `apm enable / disable / show /clear/discover/query`

The `apm` command(s) is used to display, remove, discover or query the information of VigorAP registered to VigorLTE 200.

Syntax

`apm enable`
`apm disable`
`apm show`
`apm clear`
`apm discover`
`apm query`

Syntax Description

Parameter	Description
<i>enable</i>	Enable the APM function.
<i>disable</i>	Disable the APM function.
<i>show</i>	It displays current information of APM profile.
<i>clear</i>	It is used to remove all of the APM profile.
<i>discover</i>	It is used to search VigorAP on LAN.
<i>query</i>	It is used to query any VigorAP which has been registered to APM (Central AP Management) in VigorLTE 200. Information related to the registered AP will be sent back to VigorLTE 200 for updating the web page of Central AP Management.

Example

```
> apm clear ?  
Clear all clients ... done
```

Telnet Command: `apm profile`

This command allows to configure wireless profiles to be used in Central AP Management.

Syntax

`apm profile clone <from index><to index><new name>`
`apm profile del <index>`
`apm profile reset`
`apm profile summary`
`apm profile show <profile index>`
`apm profile apply <profile index> <client index1<index2 .. index5>>`

Syntax Description

Parameter	Description
<i>clone <from index><to index><new name></i>	It is used to copy the same parameters settings from one profile to another APM profile.

	<p><from index>: Enter the index number of the profile. It is the original APM profile to be cloned to other APM profile.</p> <p><to index>: Enter an index number. It is the target profile which will clone the parameters settings from an existed APM profile.</p> <p><new name>: Enter a name for a new APM profile.</p>
<i>del</i> <index>	<p>It is used to delete a specified APM profile. The default (index #1) should not be deleted.</p> <p><index>: Enter the index number of existed profile.</p>
<i>reset</i>	It is used to reset to factory settings for WLAN profile.
<i>summary</i>	It is used to list all of the APM profiles with required information.
<i>show</i> <profile index>	<p>It is used to display specified APM profile.</p> <p><profile index>: Enter the index number of existed profile.</p>
<i>apply</i> <profile index> <client index1><index2 .. index5>>	<p>It is used to apply the selected APM profile onto specified VigorAP.</p> <p><profile index>: Enter the index number of existed profile.</p> <p><client index1... index5>: Enter the index number of the selected APM profiel to the specified VigorAP.</p>

Example

```

> apm profile clone 1 2 forcarrie
(Done)

> apm profile summary
# Name          SSID          Security    ACL    RateCtrl(U/D)
-----
0 Default      DrayTek-LAN-A  WPA+WPA2/PSK x      - / -
                DrayTek-LAN-B  WPA+WPA2/PSK x      - / -
1 -            -              -           -      -
2 forcarrie    DrayTek        Disable     x      - / -
3 -            -              -           -      -
4 -            -              -           -      -

```

Telnet Command: apm cache

This command is used to display or remove the information of registered VigorAP, including MAC address, name, and authentication. Up to 30 entries of registered information can be stored and displayed.

Syntax

apm cache show

apm cache clear

Syntax Description

Parameter	Description
<i>show</i>	It means to display the information related to VigorAP registered VigorLTE 200.

<i>clear</i>	It means to remove the information related to VigorAP registered VigorLTE 200.
--------------	--

Example

```

> apm cache show
MAC          Name          Auth
-----
>

```

Telnet Command: apm lbcfg

This command allows to set parameters related to AP management control.

Syntax

apm lbcfg <set> <value>

apm lbcfg <show>

Syntax Description

Parameter	Description
<set> <value>	<p>It means to set the load balance configuration file for APM.</p> <p><set>: Enter 1 ~ 11.</p> <p><value>: Enter 1 (enable) or 0 (disable).</p> <p>Each number represents different setting value.</p> <p>[1] - The first number means the load balance function. 1 - enable load balance, 0 - disable load balance.</p> <p>[2] - The second number means the station limit function. 1 -enable station limit, 0 - disable station limit.</p> <p>[3] - The third number means the traffic limit function. 1 - enable traffic limit, 0 - disable traffic limit.</p> <p>[4] - The forth number means the limit num of station. Available range is 3-64.</p> <p>[5] - The fifth number means the upload limit function. 1 - enable upload limit, 0 - disable upload limit.</p> <p>[6] - The sixth number means the download limit function. 1 - enable download limit, 0 - disable download limit.</p> <p>[7] - The seventh number means disassociation by idle time. 1 - enable disassociation, 0 - disable disassociation.</p> <p>[8] - The eighth number means to enable or disable disassociation by signal strength. 1 - enable disassociation, 0 - disable disassociation.</p> <p>[9] - The ninth number means to determine the unit of traffic</p>

	limit (for upload) 1 - Mbps 0 - kbps [10] - The tenth number means to determine the unit of traffic limit (for download) 1 - Mbps 0 - kbps [11] - Define the RSSI threshold (-200 ~ -50 dbm)
<i>show</i>	It shows the configuration value.

Example

```

> apm lbcfg set 1 1 1 32 100 200 1 1 1 0 -200
> apm lbcfg show
apm LoadBalance Config :
1. Enable LoadBalance : 1
2. Enable station limit : 1
3. Enable traffic limit : 1
4. Limit Number : 32
5. Upload limit : 100
6. Download limit : 200
7. Enable disassociation by idle time : 1
8. Enable disassociation by Signal strength : 1
9. Traffic limit unit (upload) : 1
10. Traffic limit unit (download) : 0
11. RSSI threshold : -200
flag : 31

```

Telnet Command: apm apsyslog

This command is used to display the AP syslog data coming from VigorAP.

Syntax

apm apsyslog <AP_Index>

Syntax Description

Parameter	Description
<AP_Index>	Specify the index number which represents VigorAP.

Example

```

> apm apsyslog 1
8d 02:46:09 syslog: [APM] Send Rogue AP Detection data.
8d 02:53:04 syslog: [APM] Run AP Detection / Discovery.
8d 02:56:09 syslog: [APM] Send Rogue AP Detection data.
8d 03:00:42 kernel: 60:fa:cd:55:f5:ea had disassociated.
8d 03:03:12 syslog: [APM] Run AP Detection / Discovery.
8d 03:06:09 syslog: [APM] Send Rogue AP Detection data.
8d 03:13:21 syslog: [APM] Run AP Detection / Discovery.
8d 03:16:10 syslog: [APM] Send Rogue AP Detection data.
8d 03:16:41 kernel: 60:fa:cd:55:f5:ea had associated successfully
8d 03:16:55 kernel: 60:fa:cd:55:f5:ea had disassociated.

```

Telnet Command: apm syslog

This command is used to display related syslog data from central AP management.

Syntax

`apm syslog`

Example

```
> apm syslog
"2015-11-04 12:24:21", "[APM] [VigorAP900_01daa902080] Get Rogue AP Detection
Data from AP"
2015-11-04 12:24:56", "[APM] [VigorAP900_01daa902080] Get Rogue AP Detection
Data from AP Success"
2015-11-04 12:34:21", "[APM] [VigorAP900_01daa902080] Get Rogue AP Detection
Data from AP"
2015-11-04 12:34:57", "[APM] [VigorAP900_01daa902080] Get Rogue AP Detection
Data from AP Success"
```

Telnet Command: apm stanum

This command is used to display the total number of the wireless clients, no matter what mode of wireless connection (2.4G WLAN or 5G WLAN) used by wireless clients to access into Internet through VigorAP.

Syntax

`apm stanum <AP_Index>`

Syntax Description

Parameter	Description
<code><AP_Index></code>	Specify the index number which represents VigorAP.

Example

```
> apm stanum
% Show the APM AP Station Number data.
% apm stanum AP_Index.
%   ex : apm stanum 1
%           Idx  Nearby(2.4/5G)  Conn(2.4/5G)
%           1    2    5            0    0
%           2    2    5            1    0
%           3    2    5            1    0
```

Index

6

- 6rd Mode, 72
- 6rd Prefix, 72
- 6rd Prefix Length, 72

A

- Access Control, 158
- Access Mode, 49
- Access Mode - Ethernet, 49
- Access Tech, 43
- Activation, 290
- Active Mode, 46, 47, 48
- Address Mapping, 140
- Administrator Password, 272
- Advance Mode, 229
- Advanced Mode, 38
- Advanced Setting, 164
- Aggregation MSDU, 164
- AH, 193
- Always On, 47, 48, 58, 64, 66, 67, 68, 69, 70, 72, 76
- AP Discovery, 167
- AP Maintenance, 309, 317
- AP Map, 309
- APN Name, 52, 53
- APP Enforcement, 225
- APP Enforcement Filter, 245
- APP Enforcement Profile, 246
- Applications, 118
- APSD Capable, 165
- ARP Cache Table, 358
- ARP Detect, 51, 56, 58
- ARP Table, 105
- Auth Type, 121
- Authentication Mode, 160
- Auto Logout, 7
- Auto-Update interval, 120
- Aux. WAN IP, 114

B

- Backup**, 105
- Backup MX, 122
- Bandwidth Limit, 292, 296
- Bind IP to MAC, 103
- Bind to WAN, 206
- Bridge**, 162
- Brute Force Protection, 283

C

- Cache, 253
- Call Direction, 195
- Call Filter, 221
- Certificate Backup, 219
- Certificate Management, 212
- Change the TTL value, 56, 59
- Channel, 74, 152, 154
- Channel Bandwidth, 164
- Choose IP, 112
- Codepage, 226
- Comment, 105, 114
- Config Backup, 13
- Configuration Backup, 275
- Configure via Client PinCode, 160
- Configure via Push Button, 160
- Connection Management, 204
- Connection Type, 121
- Connectivity, 33
- Country Code, 166
- CSM, 245
- CSV file, 327, 330

D

- Dashboard, 9, 310
- Data Coding Scheme, 40
- Data Filter, 221
- Data Flow Monitor, 364

- DataType, 49
- Daylight Saving, 279
- Default Lifetime, 96
- Default MAC Address, 57, 60
- Default Preference, 96
- Default Rule, 225
- Destination Port, 126
- Details - PPPoE, 50
- Details Page, 49
- Details-IP Routed Subnet, 92
- Details-IPv6-6in4 Static Tunnel, 70
- Details-IPv6-6rd, 72
- Details-Ipv6-AICCU, 67
- Details-IPv6-DHCPv6 Client, 68
- Details-IPv6-Offline, 64
- Details-IPv6-PPP, 64
- Details-IPv6-Static IPv6, 69
- Details-IPv6-TSPC, 65
- Details-LAN-DMZ, 90
- Details-LAN-Ethernet, 88
- Details-PPPoE, 55
- Details-PPTP/L2TP, 62
- Determine Real WAN IP, 122
- DHCP, 27
- DHCP Server Configuration, 88, 91, 93
- DHCP Server IP Address, 88, 91
- DHCP Table, 360
- DHCPv6 (Stateful), 94
- DHCPv6 Server, 95
- Diagnostics, 355, 356
- Dial-out Triggering, 356
- Digital Signature, 177, 192
- Display Name, 47, 48, 49
- DMZ Host, 111
- DNS Cache Table, 362
- DNS Server IP Address, 60, 89, 92
- DNS Server IPv6 Address, 95**
- Domain Name, 60
- DoS Defense, 222, 237, 240
- DoS Flood Table, 372
- DrayTek Banner, 235
- Dynamic DNS, 118, 119
- Dynamic DNS Account, 121

E

- Each /Shared, 297
- Enable PING to keep alive, 52, 53, 58
- End IPv6 Address, 95
- End Port, 115
- ESP, 193
- Event Code, 270
- Event Log, 319
- Extension WAN, 96

F

- Failover, 47, 48
- Failover to/Failback, 140
- File Extension Object, 341
- Filter Setup, 228
- Firewall, 221
- Firmware Upgrade, 289
- Fixed IP, 57, 63, 76
- Force Update, 119
- Fragment Length, 165**

G

- Gateway IP Address, 60, 88, 91
- General Setup, 46
- Get Community, 280
- Green Field, 164
- Group ID, 129**
- Guard Interval, 164
- GUI Map, 12

H

- Hardware Installation, 4
- Hide SSID, 155
- Host Name, 27

I

- Idle Timeout, 57, 76, 191
- IGMP, 128
- IGMP Proxy, 128**
- IGMP Snooping, 128
- IKE Authentication Method, 199

Installation, i
Inter-LAN Routing, 87
Internet Access, 49
Internet Access - Advanced, 49
IP (Internet Protocol), 45
IP Address, 60, 63, 88, 90, 93
IP Address Assignment Method(IPCP), 63
IP Bind List, 105
IP Filters, 221
IP Object, 326
IP Pool Counts, 88, 91, 93
IP Routed Subnet, 296
IPsec General Setup, 186
IPsec Tunnel, 191
IPTV, 76
IPv4 Border Relay, 72
IPv4 Mask Length, 72
IPv6 Address, 69
IPv6 Gateway Address, 69
IPv6 Group, 333
IPv6 Neighbour Table, 359
IPv6 Object, 331
IPv6 TSPC Status, 370
Isolate, 155
ISP Access Setup, 55, 62
ISP Name, 76

K

keep alive, 195
Keep Alive Period, 271
Keep WAN Connection, 52, 53, 58
Keyword Group, 340
Keyword Object, 338

L

LAN, 84
LAN- General Setup, 86
LAN Routed Prefix, 70
LAN to LAN, 193
Lease Time, 88, 91, 93
Load Balance, 321
Load Balance for AP, 309

Local Certificate, 177, 213
Local ID, 193
Local IP Address, 114
Log, 250
Login, 31
Login Name, 122
Logout, 14
Long Preamble, 164
LTE, 34
LTE hardware version, 51
LTE Status, 43
LTE WAN, 47

M

Mail Extender, 122
Main Screen, 7
Management, 266, 282
Min/Max Interval Time, 96
Mode, 151, 157
mOTP, 191, 208
MPPE, 184
MTU, 52, 56, 59, 62, 96
Multicast via VPN, 191, 208
Multiple SSID, 148
Multi-VLAN, 74
MyVigor, 252

N

Name Link, 10
NAT, 106
NAT Sessions Table, 361
NAT Traversal, 127
Netbios Naming Packet, 191
Network Configuration, 88, 90, 93
Network Interface, 145
Network Mode, 52, 53
Notification Object, 346
NS Detect, 68

O

Objects Settings, 325
Online Statistics, 299

Open Ports, 114
Operation Mode, 164
Option Number, 49

P

Packet-OVERDRIVE, 165
PAP, 184
Password, 55, 62, 66, 67, 76
Password Strength, 157, 273
Path MTU Discovery, 52, 56, 59, 62
Peer ID, 182
Physical Connection, 14
Physical Mode, 46, 47, 48, 49
Physical Type, 20, 46
PIN Code, 208
Ping Detect, 56, 58, 64, 66, 67, 68, 69, 70, 72
Ping Diagnosis, 363
Ping Gateway IP, 51, 56, 58
Ping Interval, 51, 56, 58
PING Interval, 58
Ping IP/Hostname, 64, 66, 67, 68, 69, 70, 72
Ping Retry, 51, 56, 58
Port Redirection, 107
Port Triggering, 116
Port-based Bridge, 74
Port-Based VLAN, 100
PPP Authentication, 57, 63, 76
PPP General Setup, 184
PPP Setup, 63
PPPoE, 18, 20
PPTP, 191
PPTP/L2TP, 23
Prefix Len, 145
Prefix Length, 69
Pre-shared Key, 162
Pre-Shared Key (PSK), 157
Primary DNS Sever, 95
Primary IP Address, 89, 92
Primary/Secondary Ping IP, 51, 56, 58
Priority, 48, 101, 140
Private IP, 109
Private IP Address, 45
Private Port, 109

Production Registration, 31
Provider Host, 121
Psec Peer Identity, 188
Public IP Addresss, 45
Public Port, 109

Q

Quality of Service, 292, 298
Quick Access, 11
Quick Start Wizard, 17

R

RADIUS/TACACS+, 118, 126
Rate Adaptation Algorithm, 165
Rate Control, 85
Reboot System, 288
Recipient, 130
Recipient Number, 40
Registering Vigor Router, 31
Relay Agent, 88, 91
Remote Access Control, 183
Remote Dial-in User, 190
Remote Endpoint IPv4 Address, 70
Repeater, 163
Restore, 105
RIP Protocol, 59
RIPng Protocol, 65, 68, 70, 96
Root CA, 217
Route Policy, 140
Router Advertisement Configuration, 96
Router Commands, 41
Router Name, 60, 277
Routing, 140
Routing Information Protocol, 85
Routing Table, 357
RTS Threshold, 165

S

Scan, 167
Schedule, 118, 122, 155
Secondary DNS Server, 95
Secondary IP Address, 89, 92

Security, 156, 220
Security Key, 152
Self-signed, 206
Self-Signed Certificate, 286
Send SMS, 40
Server Address, 62
Server Certificate, 206
Server IP Address, 126
Server Response, 122
Service Activation Wizard, 29
Service API, 121
Service Name, 55, 109
Service Provider, 121, 344
Service Type Group, 336
Service Type Object, 334
Sessions Control, 225
Sessions Limit, 292, 294
Set Community, 280
Set to Factory Default, 119, 123, 141
Setup Query Server, 253
Shared Secret, 126
SIM card, 34
SIM PIN code, 52, 53
Simple Mode, 37
SLAAC(stateless), 94
Smart Bandwidth Limit, 297
SMS / Mail Alert Service, 130
SMS Inbox, 37
SMS Provider, 130
SMS Quota Limit, 35
SMS/Mail Service Object, 343
SNMP, 280
Source IP, 109, 115
Specify Remote Node, 191
SPI, 222
SSID, 152
SSL Tunnel, 191
SSL VPN, 205
Start IP Address, 88, 91, 93
Start IPv6 Address, 95
Start Port, 115
Static IP, 25
Static Route, 85, 141

Static Route for IPv6, 144
Station List, 149, 168
Station Number, 320
Stations (STA), 147
Status, 311
Strict Bind, 104
Strict Security Checking, 235
Strict Security Firewall, 224
String Object, 348
STUN Settings, 271
Subnet, 101
Subnet Mask, 60, 63, 88, 90, 93
Subnet Prefix, 67
Syslog Explorer, 369
Syslog/Mail Alert, 277
System Maintenance, 267
System Status, 268

T

Tag value, 48
Tagged VLAN, 100
Temperature Sensor, 319
Time and Date, 279
Time Schedule, 297
Time Server, 279
Time Zone, 279
Total Traffic, 320
TR-069, 270
Trace Route, 368
Traffic Graph, 318, 367
Trap Community, 281
Troubleshooting, 354
Trusted CA, 218
Trusted CA Certificate, 217
TSPC, 65
TTL (Time to Live), 51, 56, 58, 64, 66, 67, 68, 69, 70, 72
Tunnel Broker, 66, 67
Tunnel ID, 67
Tunnel TTL, 70
TX Power, 165

U

Unique Local Address (ULA), 95
UPnP, 118, 127
URL Access Control, 250
URL Content Filter, 226, 245
URL Content Filter Profile, 248
User Account, 207
User Password, 273
Username, 55, 62, 66, 67, 76

V

VID, 101
View SMS Outbox Cache, 40
Virtual LAN, 85
Virtual Panel, 10
Virtual WAN, 16
VLAN, 100
VLAN Configuration, 102
VLAN Tag, 74, 101
VLAN Tag insertion, 48
VPN, 170
VPN and Remote Access, 171
VPN Client Wizard, 173
VPN Server Wizard, 179

W

WAN, 45
WAN Connection Detection, 51, 56, 58, 64, 66, 67, 68, 69, 70, 72
WAN Interface, 109, 114
WAN IP Alias, 57, 60, 63
WAN IP Network Settings, 60, 63
WAN Type, 74
WAN2, 47
WDS, 161
Web Console, 13
Web Content Filter, 226, 245
Web Content Filter Profile, 252
Web Feature, 251
WEP, 148, 157
white/black list, 158
Wildcard, 122
Wireless LAN, 146
Wireless Wizard, 151
Wizard Mode, 229
WLAN Isolation, 148
WLAN Profile, 312
WMM Capable, 165
WPA, 148, 157
WPS, 149, 160