

ioLogik R1200 Series User's Manual

Edition 2.2, September 2016

www.moxa.com/product

MOXA®

© 2016 Moxa Inc. All rights reserved.

ioLogik R1200 Series User's Manual

The software described in this manual is furnished under a license agreement and may be used only in accordance with the terms of that agreement.

Copyright Notice

© 2016 Moxa Inc. All rights reserved.

Trademarks

The MOXA logo is a registered trademark of Moxa Inc.
All other trademarks or registered marks in this manual belong to their respective manufacturers.

Disclaimer

Information in this document is subject to change without notice and does not represent a commitment on the part of Moxa.

Moxa provides this document as is, without warranty of any kind, either expressed or implied, including, but not limited to, its particular purpose. Moxa reserves the right to make improvements and/or changes to this manual, or to the products and/or the programs described in this manual, at any time.

Information provided in this manual is intended to be accurate and reliable. However, Moxa assumes no responsibility for its use, or for any infringements on the rights of third parties that may result from its use.

This product might include unintentional technical or typographical errors. Changes are periodically made to the information herein to correct such errors, and these changes are incorporated into new editions of the publication.

Technical Support Contact Information

www.moxa.com/support

Moxa Americas

Toll-free: 1-888-669-2872
Tel: +1-714-528-6777
Fax: +1-714-528-6778

Moxa Europe

Tel: +49-89-3 70 03 99-0
Fax: +49-89-3 70 03 99-99

Moxa India

Tel: +91-80-4172-9088
Fax: +91-80-4132-1045

Moxa China (Shanghai office)

Toll-free: 800-820-5036
Tel: +86-21-5258-9955
Fax: +86-21-5258-5505

Moxa Asia-Pacific

Tel: +886-2-8919-1230
Fax: +886-2-8919-1231

Table of Contents

1. Overview	1-1
Introduction	1-2
Product Features	1-2
Package Checklist	1-2
Product Model Information	1-2
Ordering Information	1-2
Specifications	1-3
Common Specifications	1-3
ioLogik R1210	1-4
ioLogik R1212	1-4
ioLogik R1214	1-5
ioLogik R1240	1-6
ioLogik R1241	1-6
Physical Dimensions	1-7
Hardware Reference	1-7
Panel Guide	1-7
LED Indicators	1-8
Switch Settings	1-8
DI Circuit Diagram	1-8
DIO Circuit Diagram	1-9
Relay Circuit Diagram	1-10
AI Circuit Diagram	1-10
2. Initial Setup	2-1
Hardware Installation	2-2
Connecting the Power	2-2
Grounding the ioLogik R1200	2-2
Connecting to Serial Interface	2-2
Mounting the ioLogik R1200	2-2
Connecting to Digital Sensors and Devices	2-3
RS-485 Networks	2-4
Modbus/RTU Devices	2-5
Dual RS-485 or Repeater Settings	2-5
Jumper Settings (DIO and AI)	2-6
Pull High/Low DIP Switch Settings for the RS-485 Port	2-6
Software Installation	2-7
ioSearch Installation	2-7
Initial Setup by USB	2-9
Restore Factory Default Settings	2-10
3. Using ioSearch	3-1
Introduction to ioSearch	3-2
ioSearch Main Screen	3-2
Main Screen Overview	3-2
ioSearch Setup	3-3
System	3-3
Sort	3-5
Help	3-6
Quick Links	3-6
Main Functions	3-6
Locate	3-6
Connect/Disconnect	3-6
Firmware Upgrade	3-7
Import	3-7
Export	3-7
Change Server Name	3-7
Restart System	3-8
Delete ioLogik Device	3-8
Reset to Default	3-8
Main Screen	3-9
I/O Configuration Tab (General)	3-9
Configuring Digital Input Channels	3-9
Configuring Digital Output Channels	3-11
Configuring Analog Input Channels	3-13
AI Input Range	3-13
Configuring Analog Output Channels	3-14
Server Info Tab	3-16
Server Settings Tab (General)	3-17
Watchdog	3-18

A. Modbus Mapping	A-1
R1210 Modbus Mapping.....	A-2
0xxxx Read/Write Coils (Functions 1, 5, 15)	A-2
1xxxx Read Only Coils (Function 2)	A-4
3xxxx Read Only Registers (Function 4)	A-4
4xxxx Read/Write Registers (Functions 3, 6, 16)	A-5
R1212 Modbus Mapping.....	A-6
0xxxx Read/Write Coils (Functions 1, 5, 15)	A-6
1xxxx Read Only Coils (Function 2)	A-9
3xxxx Read Only Registers (Function 4)	A-9
4xxxx Read/Write Registers (Functions 3, 6, 16)	A-10
R1214 Modbus Mapping.....	A-12
0xxxx Read/Write Coils (Functions 1, 5, 15)	A-12
1xxxx Read Only Coils (Function 2)	A-14
3xxxx Read Only Registers (Function 4)	A-14
4xxxx Read/Write Registers (Functions 3, 6, 16)	A-14
R1240 Modbus Mapping.....	A-15
0xxxx Read/Write Coils (Functions 1, 5, 15)	A-15
3xxxx Read Only Registers (Function 4)	A-16
4xxxx Read/Write Registers (Functions 3, 6, 16)	A-17
R1241 Modbus Mapping.....	A-18
4xxxx Read/Write Registers (Functions 3, 6, 16)	A-18
B. Factory Defaults	B-1
C. Pinouts	C-1
D. FCC Interference Statement	D-1
E. European Community (CE)	E-1

The following topics are covered in this chapter:

- **Introduction**
- **Product Features**
- **Package Checklist**
- **Product Model Information**
 - Ordering Information
- **Specifications**
 - Common Specifications
 - ioLogik R1210
 - ioLogik R1212
 - ioLogik R1214
 - ioLogik R1240
 - ioLogik R1241
- **Physical Dimensions**
- **Hardware Reference**
 - Panel Guide
 - LED Indicators
 - Switch Settings
 - DI Circuit Diagram
 - DIO Circuit Diagram
 - Relay Circuit Diagram
 - AI Circuit Diagram

Introduction

The ioLogik R1200 is an industrial grade, wide-temperature serial remote I/O device equipped with dual RS-485 ports that allow users to select between two RS-485 serial ports or switch to a built-in repeater. Applications such as factory automation, security and surveillance systems, and tunnel monitoring can use the RS-485 serial line to set up multi-drop device configurations through serial cables. Furthermore, a technician with no serial background can upload device configurations and firmware via USB at the field site without bringing a PC to the field site. The ioLogik R1200 lets you easily build an industrial grade, long distance communication system with standard PC hardware, and extends the communication distance by 4,000 ft. (1,200 m).

Product Features

- Upload and install device configurations and firmware via USB
- Multi-drop support for device configuration and firmware upgrade via RS-485
- Remote firmware updates via RS-485
- Dual RS-485 ports with built-in repeater
- Wide temperature (-40 to 85°C), 1 kV surge protection, and 3 kV I/O isolation between I/O channels, networks and power circuits
- Multi-functional I/O support for DI, event counter, DO, and pulse output
- Modbus/RTU support for control by SCADA software, including Wonderware InTouch and GE Intellution iFix32
- Monitoring and configuration via ioSearch Windows utility
- Hardware detection over RS-485 via ioSearch

Package Checklist

The ioLogik R1200 is shipped with the following items:

- 1 ioLogik R1200 remote I/O product
- Quick Installation Guide (printed)

NOTE	Contact your sales representative if any of the above items are missing or damaged.
-------------	---

Product Model Information

Ordering Information

ioLogik R1210	RS-485 remote I/O, 16 DIs, -10 to 75°C operating temperature.
ioLogik R1210-T	RS-485 remote I/O, 16 DIs, -40 to 85°C operating temperature.
ioLogik R1212	RS-485 remote I/O, 8 DIs, 8 DIOs, -10 to 75°C operating temperature.
ioLogik R1212-T	RS-485 remote I/O, 8 DIs, 8 DIOs, -40 to 85°C operating temperature.
ioLogik R1214	RS-485 remote I/O, 6 DIs, 6 Relays, -10 to 75°C operating temperature.
ioLogik R1214-T	RS-485 remote I/O, 6 DIs, 6 Relays, -40 to 85°C operating temperature.
ioLogik R1240	RS-485 remote I/O, 8 AIs, -10 to 75°C operating temperature.
ioLogik R1240-T	RS-485 remote I/O, 8 AIs, -40 to 85°C operating temperature.
ioLogik R1241	RS-485 remote I/O, 4 AOs, -10 to 75°C operating temperature.
ioLogik R1241-T	RS-485 remote I/O, 4 AOs, -40 to 85°C operating temperature.

Specifications

Common Specifications

Serial Communication

Interface: RS-485-2w: Data+, Data-, GND (5-contact terminal block)

Serial Line Protection: 15 kV ESD for all signals, Level 2 surge, EN 61000-4-5 (1 kV)

Serial Communication Parameters

Parity: None, Even, Odd (default = None)

Data Bits: 8

Stop Bits: 1, 2 (default = 1)

Baudrate: 1200 to 921.6 kbps (default = 9600)

Pull High/Low Resistor for RS-485: 1 k Ω , 150 k Ω

Protocols: Modbus RTU

Physical Characteristics

Wiring: I/O cable max. 16 AWG

Dimensions: 27.8 x 124 x 84 mm (1.09 x 4.88 x 3.31 in)

Environmental Limits

Operating Temperature:

Standard Models: -10 to 75°C (14 to 167°F)

Wide Temp. Models: -40 to 85°C (-40 to 185°F)

Storage Temperature: -40 to 85°C (-40 to 185°F)

Ambient Relative Humidity: 5 to 95% (non-condensing)

Standards and Certifications

Safety: UL 508

EMI:

EN 55022, EN 61000-3-2, EN 61000-3-3, FCC Part 15 Subpart B Class A

EMS:

EN 55024, IEC 61000-4, IEC 61000-6

Shock: IEC 60068-2-27

Freefall: IEC 60068-2-32

Vibration: IEC 60068-2-6

Warranty

Warranty Period: 5 years (excluding the ioLogik R1214)

Details: See www.moxa.com/warranty

ioLogik R1210

Inputs and Outputs

Digital Inputs: 16 channels

Isolation: 3K VDC or 2K Vrms

Digital Input

Sensor Type: Wet Contact (NPN or PNP), Dry Contact

I/O Mode: DI or Event Counter

Dry Contact:

- On: short to GND
- Off: open

Wet Contact (DI to COM):

- On: 10 to 30 VDC
- Off: 0 to 3 VDC

Common Type: 8 points per COM

Counter Frequency: 2.5 kHz, power off storage

Digital Filtering Time Interval: Software selectable

Power Requirements

Power Input: 24 VDC nominal, 12 to 48 VDC

Power Consumption: 154 mA @ 24VDC

ioLogik R1212

Inputs and Outputs

Digital Inputs: 8 channels

Configurable DIOs: 8 channels

Isolation: 3K VDC or 2K Vrms

Digital Input

Sensor Type: Wet Contact (NPN or PNP), Dry Contact

I/O Mode: DI or Event Counter

Dry Contact:

- On: short to GND
- Off: open

Wet Contact (DI to COM):

- On: 10 to 30 VDC
- Off: 0 to 3 VDC

Common Type: 8 points per COM

Counter Frequency: 2.5 kHz, power off storage

Digital Filtering Time Interval: Software selectable

Digital Output

Type: Sink

I/O Mode: DO or Pulse Output

Pulse Output Frequency: 5 kHz

Over-voltage Protection: 45 VDC

Over-current Protection: 2.6 A (4 channels @ 650 mA)

Over-temperature Shutdown: 175°C (typical), 150°C (min.)

Current Rating: 200 mA per channel

Power Requirements

Power Input: 24 VDC nominal, 12 to 48 VDC

Power Consumption: 187 mA @ 24VDC

ioLogik R1214

Inputs and Outputs

Digital Inputs: 6 channels

Relay Outputs: 6 channels

Isolation: 3K VDC or 2K Vrms

Digital Input

Sensor Type: Wet Contact (NPN or PNP), Dry Contact

I/O Mode: DI or Event Counter

Dry Contact:

- On: short to GND
- Off: open

Wet Contact (DI to COM):

- On: 10 to 30 VDC
- Off: 0 to 3 VDC

Common Type: 6 points per COM

Counter Frequency: 2.5 kHz, power off storage

Digital Filtering Time Interval: Software selectable

Relay Output

Type: Form A (N.O.) power relay

Contact Current Rating:

- Resistive Load: 5 A @ 30 VDC, 250 VAC, 110 VAC

Breakdown Voltage: 500 VAC

Relay On/Off Time: 1500 ms (Max.)

Initial Insulation Resistance: 1000 M ohms (min.) @ 500 VDC

Mechanical Endurance: 5,000,000 operations

Electrical Endurance: 100,000 operations @ 5 A resistive load

Contact Resistance: 100 m ohms (max.)

Pulse Output: 0.3 Hz at rated load

Note: Ambient humidity must be non-condensing and remain between 5 and 95%. The relays of the ioLogik R1214 may malfunction when operating in high condensation environments below 0°C.

Power Requirements

Power Input: 24 VDC nominal, 12 to 48 VDC

Power Consumption: 207 mA @ 24VDC

ioLogik R1240

Inputs and Outputs

Analog Inputs: 8 channels

Isolation: 3K VDC or 2K Vrms

Analog Input

Type: Differential input

Resolution: 16 bits

I/O Mode: Voltage / Current

Input Range: 0 to 10 VDC, 0 to 20 mA, 4 to 20 mA (burn-out mode)

Accuracy:

±0.1% FSR @ 25°C

±0.3% FSR @ -10 and 60°C

±0.5% FSR @ -40 and 75°C

Sampling Rate (all channels):

12 Hz

Input Impedance: 10M ohms (min.)

Built-in Resistor for Current Input: 120 ohms

Power Requirements

Power Input: 24 VDC nominal, 12 to 48 VDC

Power Consumption: 216 mA @ 24VDC

ioLogik R1241

Inputs and Outputs

Analog Outputs: 4 channels

Isolation: 3K VDC or 2K Vrms

Analog Output

Resolution: 12 bits

Output Range: 0 to 10 VDC, 4 to 20 mA

Voltage Output: 10 mA (max.)

Accuracy:

±0.1% FSR @ 25°C

±0.3% FSR @ -40 and 75°C

Load Resistor:

• Internal power: 400 ohms

• External 24V power: 1000 ohms

Power Requirements

Power Input: 24 VDC nominal, 12 to 48 VDC

Power Consumption: 343 mA @ 24VDC

Physical Dimensions

The dimensions of the ioLogik R1200 product are 27.8 x 124 x 84 mm. The connector for the two RS-485 ports is a 5-pin 3.81 terminal block (2 RS-485 ports with 1 ground pin). The power connector is on the top and the reset button is on the bottom of the product. There are also two dials for Board ID setup, and a 2-pin DIP switch for "Initial/Run" mode and "Dual RS-485/Repeater" mode setup.

Unit: mm (inch)

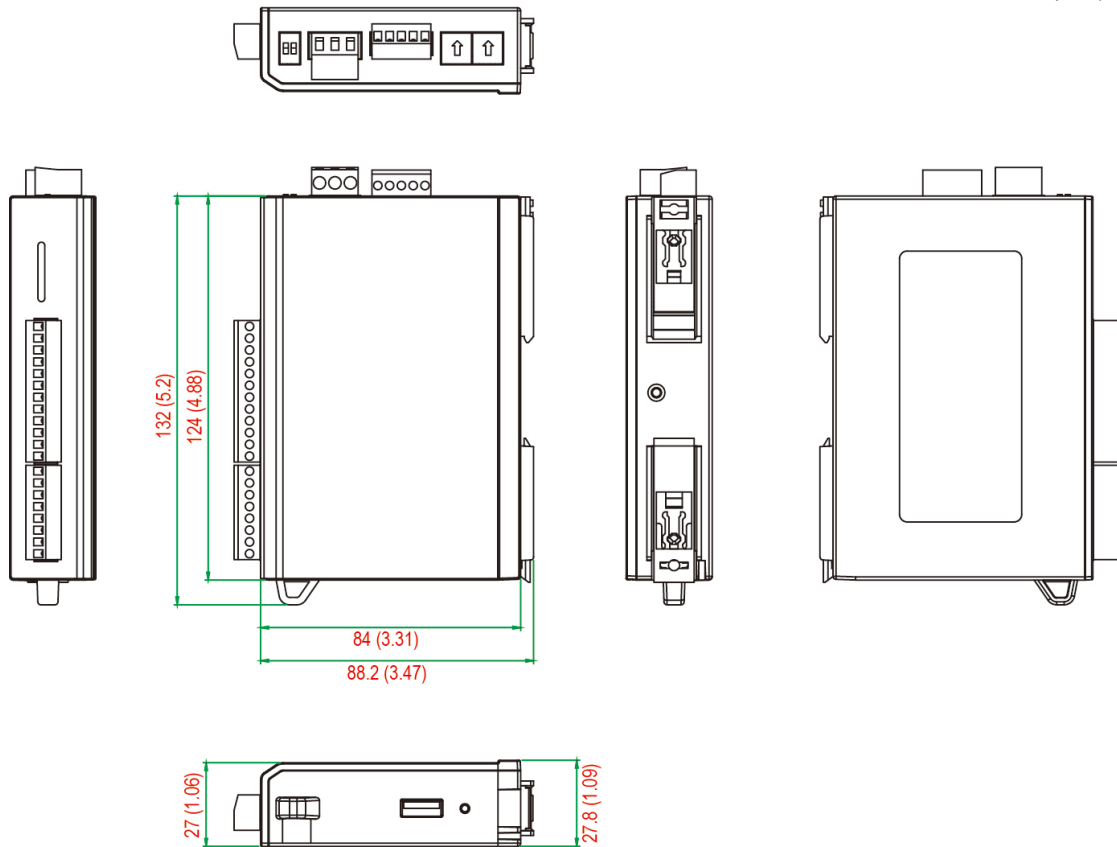

Hardware Reference

Panel Guide

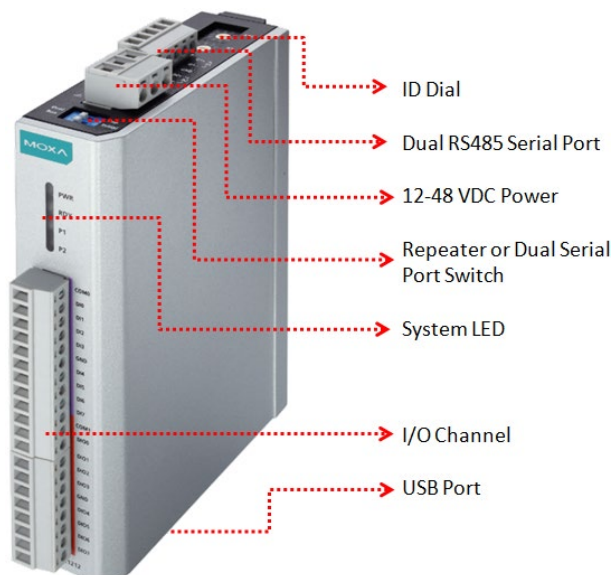

NOTE The RESET button restarts the server and resets all settings to factory defaults. Use a pointed object such as a straightened paper clip to hold down the reset button for 5 seconds. The factory defaults will load once the READY LED turns green again. You may then release the RESET button.

LED Indicators

LED	State	Description
Power (PWR)	Amber	System power is ON
	OFF	System power is OFF
Read (RDY)	Green	System is ready
	Flashing	Flashes every 1 sec when the Locate function is triggered
	Flashing	Flashes every 0.5 sec when the firmware is being upgraded
	Flashing	Flashing USB upgrade is triggered
	OFF	System is not ready.
Port 1 (P1)	Green	Serial connection enabled
	Flashing	Transmitting or receiving data
Port 2 (P2)	Green	Serial connection enabled
	Flashing	Transmitting or receiving data

Switch Settings

The R1200 series provides Dual/Rep and Run/Initial switch settings for setting the communication mode.



- | | |
|-------------------|---|
| Dual (Default) | Dual RS-485 mode |
| Rep | Repeater mode |
| Run | User defined communication parameters |
| Initial (Default) | Initial RS-485 communication parameters |

DI Circuit Diagram

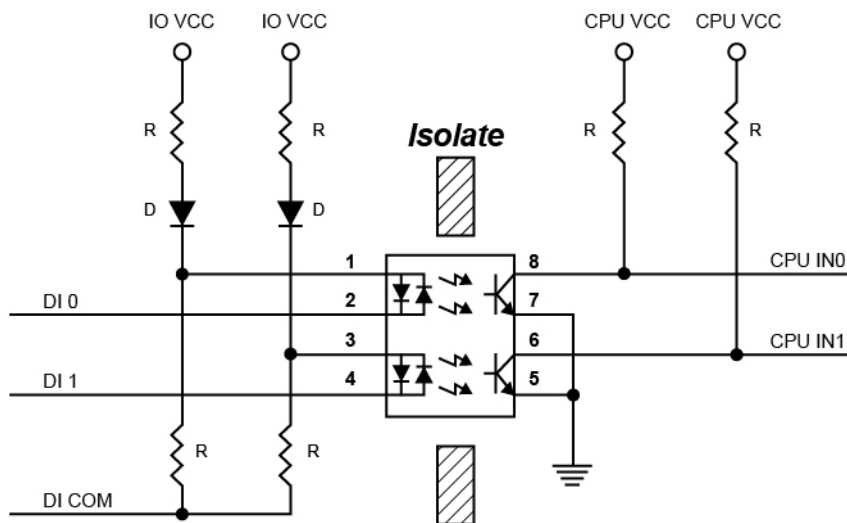

DIO Circuit Diagram

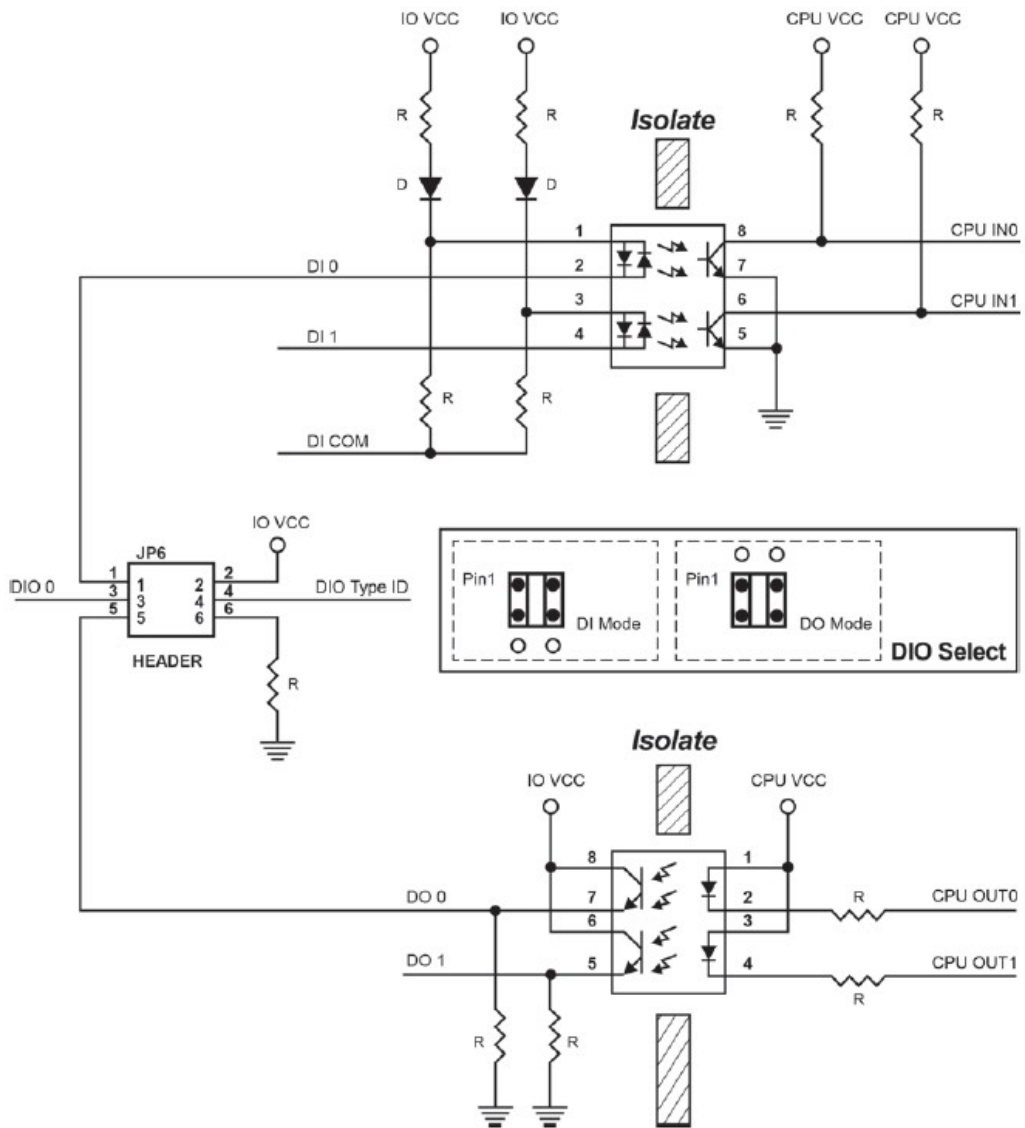

Relay Circuit Diagram

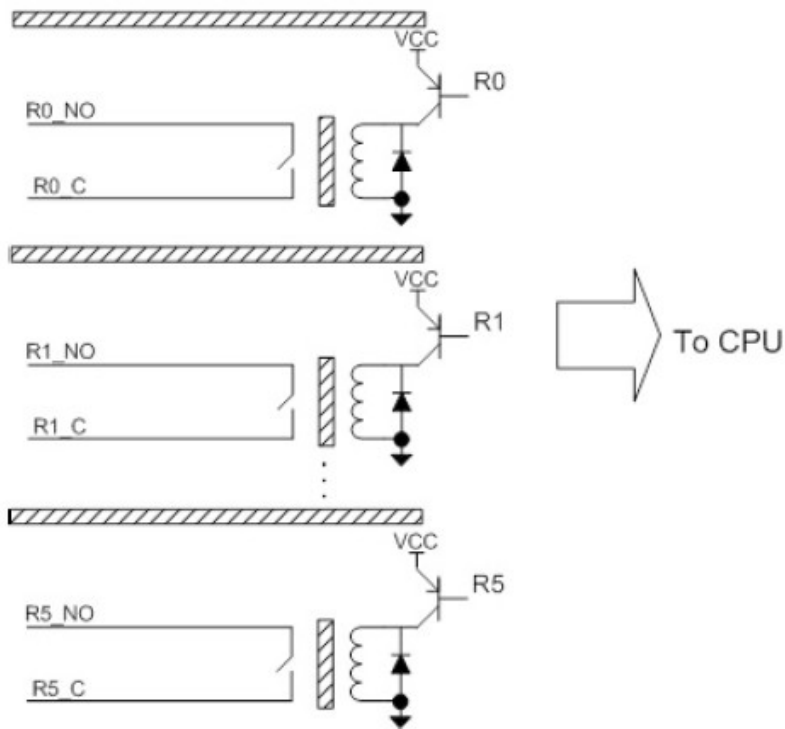

AI Circuit Diagram

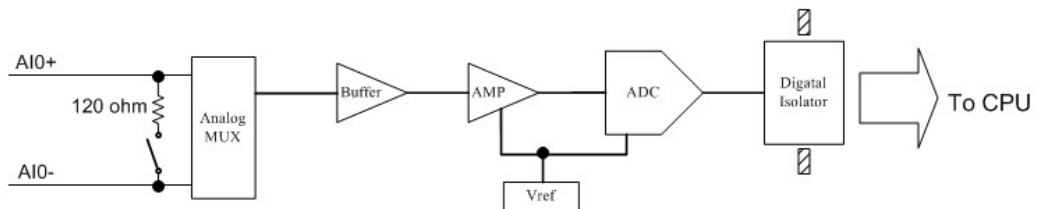

The following topics are covered in this chapter:

▣ **Hardware Installation**

- Connecting the Power
- Grounding the ioLogik R1200
- Connecting to Serial Interface
- Mounting the ioLogik R1200
- Connecting to Digital Sensors and Devices
- RS-485 Networks
- Modbus/RTU Devices
- Dual RS-485 or Repeater Settings
- Jumper Settings (DIO and AI)
- Pull High/Low DIP Switch Settings for the RS-485 Port

▣ **Software Installation**

- ioSearch Installation
- Initial Setup by USB
- Restore Factory Default Settings

Hardware Installation

Connecting the Power

Connect the 12 to 48 VDC power line to the ioLogik R1200's terminal block on the top panel. If power is properly supplied, the Power LED will glow a solid amber color.

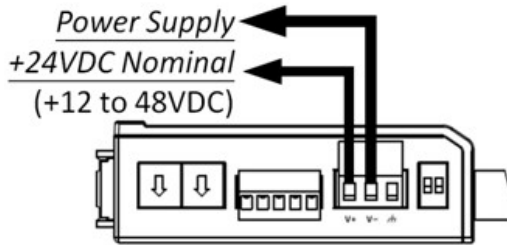

ATTENTION

Determine the maximum possible current for each power wire and common wire. Observe all electrical codes dictating the maximum current allowable for each wire size. If the current exceeds the maximum rating, the wiring could overheat, causing serious damage to your equipment. For safety reasons, we recommend an average cable size of 22 AWG. However, depending on the current load, you may want to adjust your cable size (the maximum wire size for power connectors is 2 mm).

Grounding the ioLogik R1200

The ioLogik R1200 is equipped with a grounding point on the terminal block located on the top panel. Connect the ground pin if an earth ground is available.



Connecting to Serial Interface

TB1 and TB2 (two RS-485 2-wire connectors)

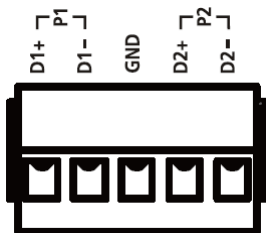

	TB1 (RS-485)			TB2 (RS-485)		
Pin	1	2	3	4	5	3
Signal	D1+	D1-	GND	D2+	D2-	GND

NOTE TB1 and TB2 share the same ground.

Mounting the ioLogik R1200

The ioLogik R1200 can be used with both DIN rail and wall mounting applications.

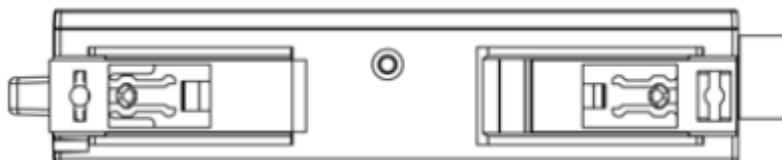

Connecting to Digital Sensors and Devices

Digital Input/Output (Sink Type)

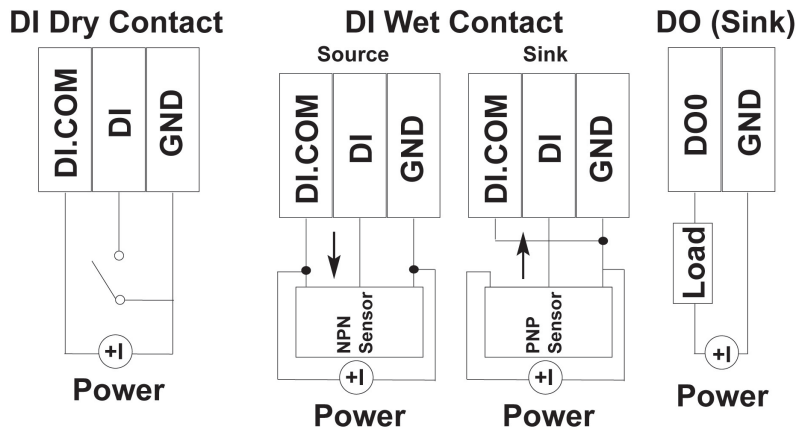

A **Dry Contact** is a contact that does not provide voltage, e.g., the push-to-talk switch of a microphone, which just closes a circuit without providing voltage.

A **Wet Contact** is a contact that will provide voltage when closed, e.g., a switch on the wall that activates a 110 VAC outlet to turn a lamp on in a room.

Analog Input/Output

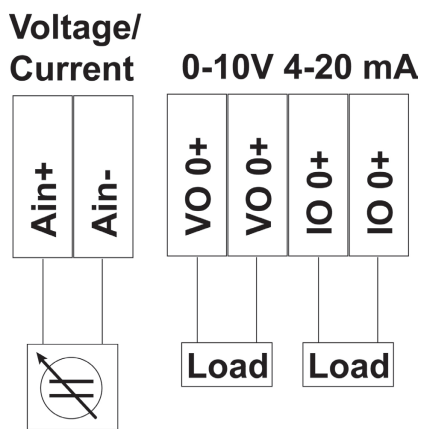

Relay Output (Form A)

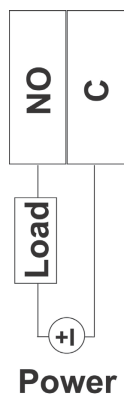

NOTE A “load” in a circuit schematic is a component or portion of the circuit that consumes electric power. For the diagrams shown in this document, “load” refers to the devices or systems connected to the remote I/O unit.

RS-485 Networks

RS-485 permits a balanced transmission line to be shared in a party line or multi-drop configuration. As many as 32 driver/receiver pairs can share a multi-drop connection on a single two-wire bus. The length of the network is limited to 4,000 ft between the first node and the last node. You can use RS-485 in two-wire or four-wire multi-drop network applications.

In an RS-485 four-wire network, one node must be a master node and all others slave nodes. The master does not require tri-state output.

NOTE The transmission line is terminated on both ends of the line but not at drop points in the middle of the line. Termination is only required with high data rates or long wire runs.

Setting the Device ID for RS-485 Serial Communication

The RS-485 port is used to communicate with other RS-485 devices or to link to another ioLogik RS-485 I/O server. The RS-485 port can run Modbus/RTU or I/O command sets. The device ID for each ioLogik R1200 device can be set to any number from 01 to 99 by turning the two rotary dials on the back of the device. The x1 dial (shown on the left in the figure below) represents the ones place and the x10 dial (shown on the right in the figure below) represents the tens place. Settings such as the baud rate, parity check, data bits, and stop bit are configured by software.

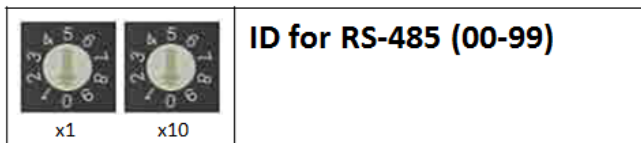

Serial Communication Parameters (Initial State)

Communication Parameters (Initial mode)	
Parity	None, Even, Odd (default = None)
Data Bits	8
Stop Bits	1, 2 (default = 1)
Baudrate	1200 to 921.6 kbps (default = 9600)

Serial Communication Initial Setup

During your initial setup, set the switch to “Initial” mode to configure your device, after configuration is done flip the switch back to “Run” mode.



NOTE The initial communication setting is: baudrate = 9600, n, 8, 1.

Modbus/RTU Devices

The RS-485 port runs Modbus/RTU and can connect to any Modbus device. You may use different methods to connect different combinations of ioLogik R1200 servers and other Modbus devices. Some examples are shown below:

Connecting One Modbus/RTU Device

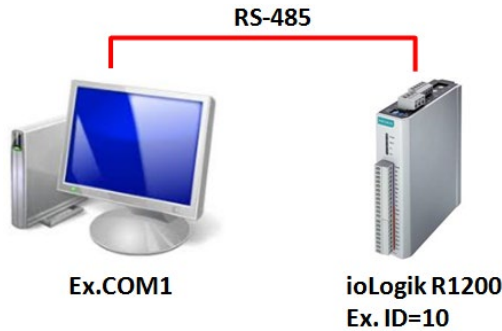

Connecting Multiple Modbus/RTU Devices

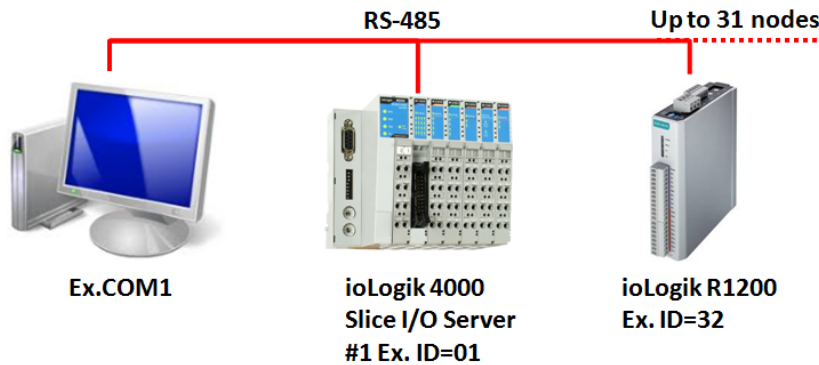

Dual RS-485 or Repeater Settings

Dual RS-485: Switching the dial to "Dual" will divide the RS-485 port into two separate RS-485 ports for users to run dual RS-485 lines.



Repeater: Switching the dial to "Rep" will set the ioLogik R1200 to act as a repeater.

NOTE In Repeater mode, when signals pass through one machine, the latency will increase by 1 byte with a maximum of 10 ms at 1200 bps baudrate.



Jumper Settings (DIO and AI)

The models with DIO or AI channels require configuring the jumpers inside the cover. Remove the screw located on the back panel and open the cover to configure the jumpers.

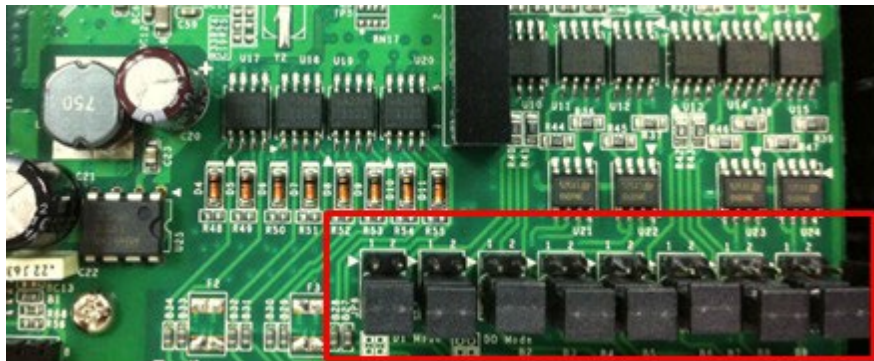

DIO mode configuration is shown to the right (default: DO Mode).

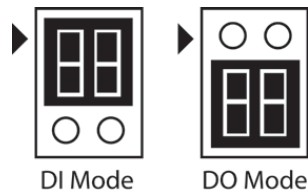

Analog mode configuration is shown to the right (default: Voltage Mode).

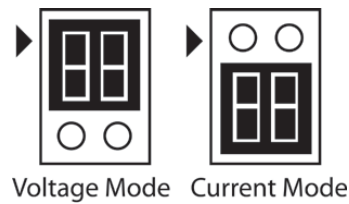



ATTENTION
Remove the screw on the back panel and open the cover to configure the jumpers.

Pull High/Low DIP Switch Settings for the RS-485 Port

In some critical environments, you may need to add termination resistors to prevent the reflection of serial signals. When using termination resistors, it is important to set the pull high/low resistors correctly so that the electrical signal is not corrupted. Since there is no resistor value that works for every environment, DIP switches are used to set the pull high/low resistor valve for each RS-485 port.

DIP switches inside the cover of the ioLogik R1200 are used to set the pull high/low resistor values for each serial port.

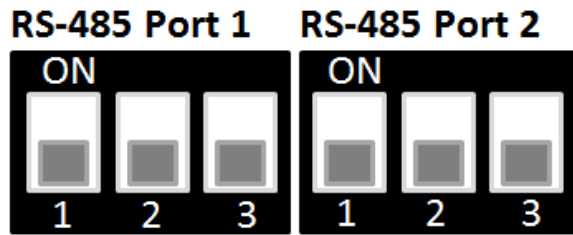

*Default setting (high/low resistors to 150 KΩ)

To set the pull high/low resistors to 150 kΩ, make sure both of the assigned DIP switches are in the OFF position (default setting).

To set the pull high/low resistors to 1 kΩ, make sure both of the assigned DIP switches are in the ON position.

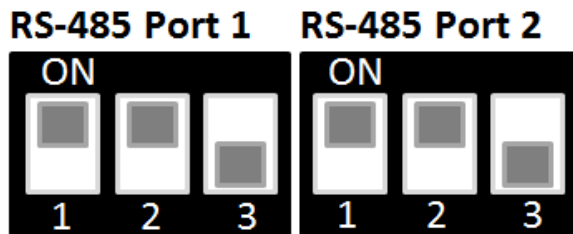

* high/low resistors to 1 KΩ

Pull High/Low DIP switch settings for the RS-485 Port

Switch	1	2	3
	Pull High/Low	Pull High/Low	Terminator
ON	1 kΩ	1 kΩ	120 Ω
OFF (default)	150 kΩ	150 kΩ	----

Software Installation

ioSearch Installation

ioSearch™ is a search utility that helps the user locate ioLogik R1200 devices on the local RS-485 network. The latest version can be downloaded from Moxa's website.

- 1. Install from the website:** To download the software from Moxa's website, first click on the following link to access the website's search utility: <http://www.moxa.com/support/search.aspx?type=soft>. When the webpage opens, enter the model name of your product in the search box. Click the model name and navigate to the product page, and then click on ioSearch, located in the box titled Software. Download and then unzip the file, and then run SETUP.EXE from that location. The installation program will guide you through the installation process and install the software. You can also install the MXIO DLL library separately.
- 2. Open ioSearch:** After installation is complete, run ioSearch from **Start → Program Files → MOXA → IO Server → Utility → ioSearch**
- 3. Search for the server:** On the menu bar, select **System → Auto Search Remote I/O Server**. In the dialog window, select "RS-232/485 I/O server" and click "Start Search."

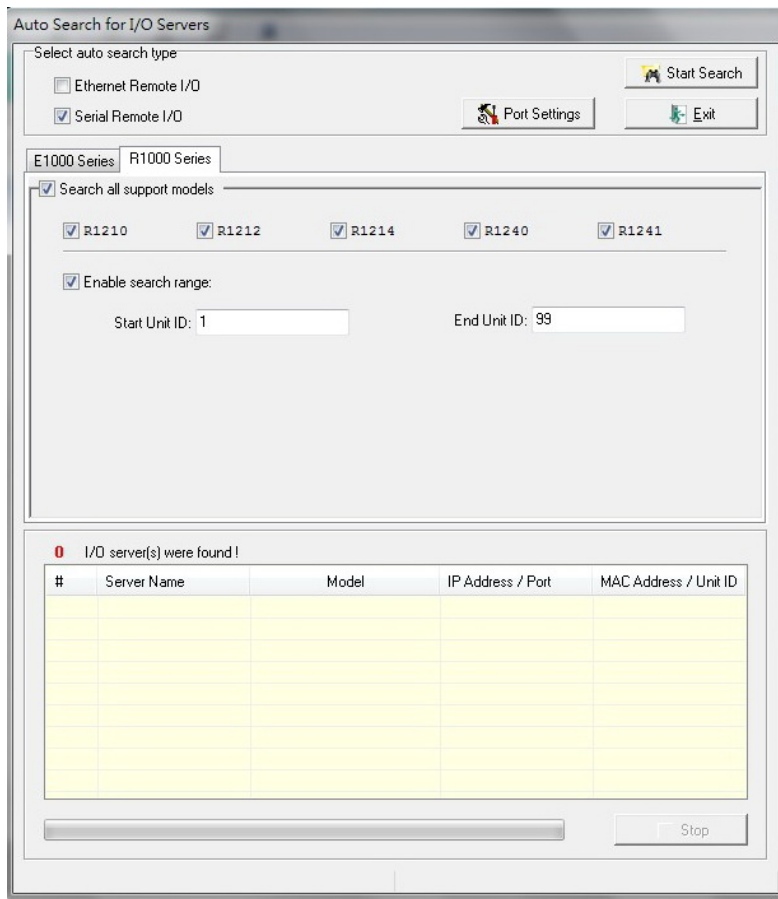

- If multiple ioLogik R1200 units are installed on the same network, remember to assign a unique device ID to each unit to avoid conflicts.
 - If ioSearch is unable to find the ioLogik R1200 device, there may also be a problem with your COM port settings. Click “Port Settings” to view or modify the settings.
4. **Monitor I/O status:** Once the unit is found by ioSearch, you can view the status of all connected I/O devices on the ioSearch main screen.

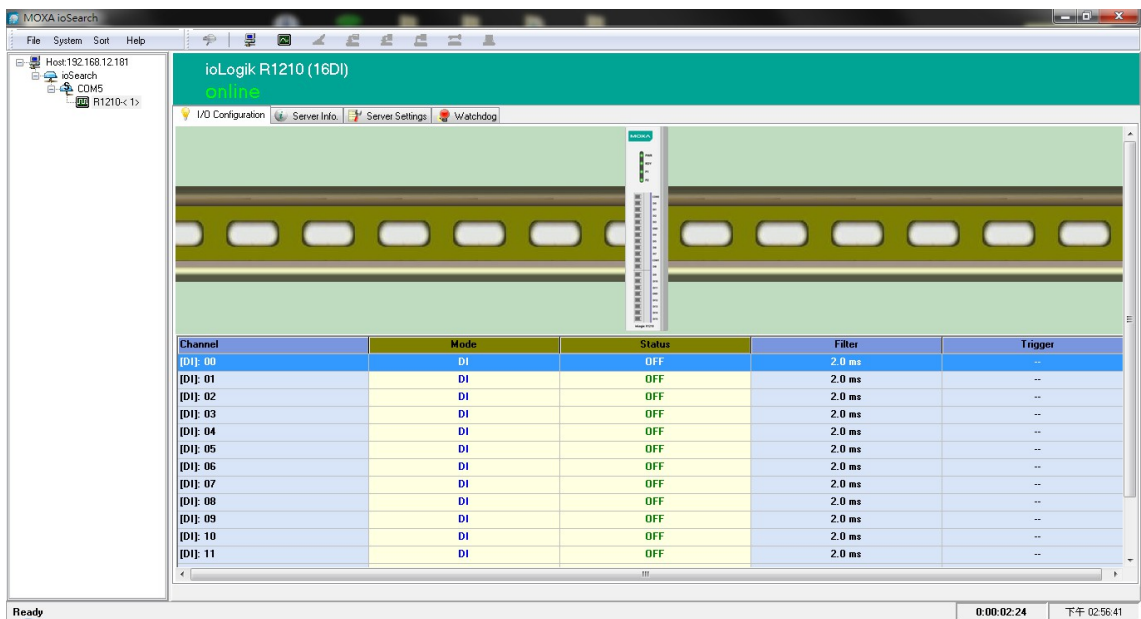

Initial Setup by USB

When setting up your ioLogik R1200 for the first time, you need to import the initial configuration and firmware files onto a USB drive. But before you connect the USB drive to the ioLogik R1200's USB port to install and upgrade configurations and firmware, you first need to place the configuration files under a designated folder.

NOTE The USB format should be FAT or FAT32. The NTFS format is not supported.

Import Configuration File

To import configuration files via USB, follow these steps:

1. Create a new "config" folder on the USB drive
2. Use the ioSearch utility to export the configuration file from the device and place the file into the "config" folder created in step 1 (above):
X : \config\R12YY.txt
(X represents the USB drive, and R12YY represents the model type)

Upgrade Firmware

To upgrade the firmware by USB, follow these steps:

1. Create a new "fwr" folder on the USB drive.
2. Place the firmware file under the folder created in step 1:
X : \fwr\R12YY.1kp
(X represents the USB drive, and R12YY represent the model type)

Configure the Device

After you set up the USB drive, follow the steps below to configure your ioLogik R1200 device.

1. Power off the ioLogik R1200.
2. Set the DIP switch to "Initial" mode.



3. Plug the USB drive into the ioLogik R1200 device.
4. Power on the ioLogik R1200 and the USB drive will automatically install the system files.
(Process: Rdy LED Red blinking 3s, then Green blinking,
Result: RdyLED Green: pass, Rdy Red: Failed)

5. Power off the ioLogik R1200 device.
6. Unplug the USB drive.
7. Set the DIP switch to "Run" mode.



Restore Factory Default Settings

There are two ways to restore the ioLogik R1200 device to the factory default settings.

1. Hold the reset button for 5 seconds.
2. Right-click on the ioLogik unit you want to restore in the ioSearch utility and change "Reset" to "Default."

The following topics are covered in this chapter:

- ❑ **Introduction to ioSearch**
- ❑ **ioSearch Main Screen**
- ❑ **Main Screen Overview**
- ❑ **ioSearch Setup**
 - System
 - Sort
 - Help
- ❑ **Quick Links**
- ❑ **Main Functions**
 - Locate
 - Connect/Disconnect
 - Firmware Upgrade
 - Import
 - Export
 - Change Server Name
 - Restart System
 - Delete ioLogik Device
 - Reset to Default
- ❑ **Main Screen**
 - I/O Configuration Tab (General)
 - Configuring Digital Input Channels
 - Configuring Digital Output Channels
 - Configuring Analog Input Channels
 - AI Input Range
 - Configuring Analog Output Channels
- ❑ **Server Info Tab**
 - Server Settings Tab (General)
 - Watchdog

Introduction to ioSearch

The ioSearch utility is used for locating or searching for an Logik R1200 unit on the physical network. The following functions are supported by the ioSearch utility.

- Search for and locate ioLogik R1200 units
- Configure communication address
- Upgrade firmware for multiple ioLogik R1200 units
- Export configuration files from multiple ioLogik R1200 units
- Import a configuration file to multiple ioLogik R1200 units
- Reset to default

ioSearch Main Screen

The main screen of the ioSearch utility defaults to the I/O Configuration tab, which displays an image of the ioLogik R1200 and the status of each I/O channel. The other tabs on the main screen take you to server and network settings, and additional functions are available when you log on as an administrator. Note that configuration options are not available until you log on as an administrator.

Main Screen Overview

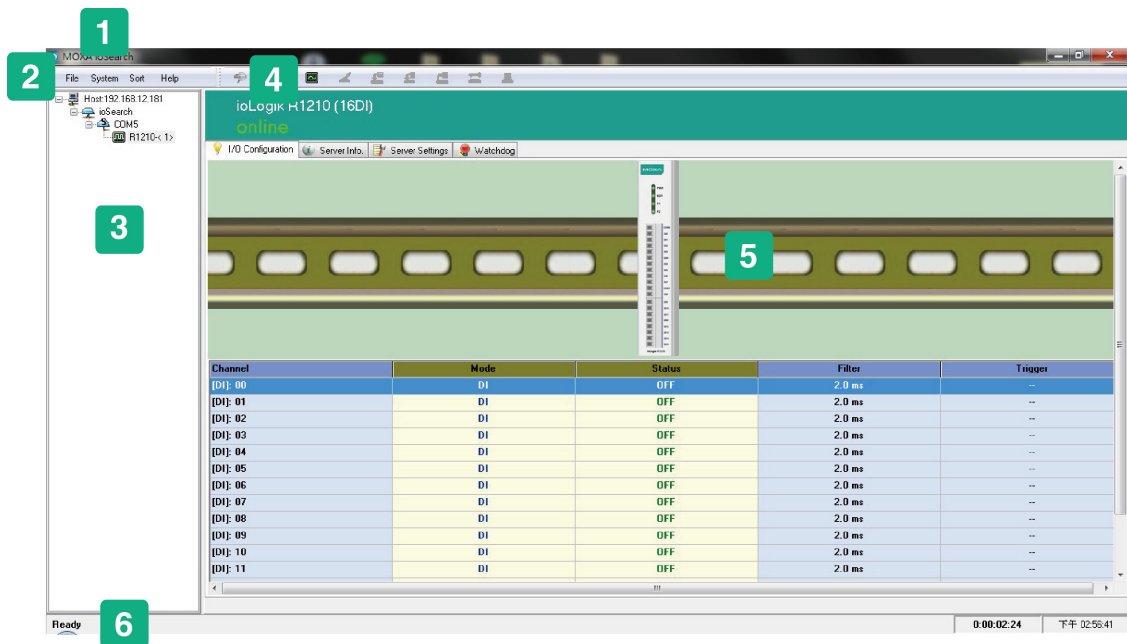

ioSearch Main Screen	
1	Title
2	Menu bar
3	Navigation panel
4	Quick link
5	Main window
6	Status Bar

ioSearch Setup

System

Several functions are available from the **System** menu.

Auto Search Remote Ethernet I/O Servers will search for ioLogik servers on the network. When connecting for the first time or recovering from a network disconnection, you can use this command to find I/O servers that are on the network.

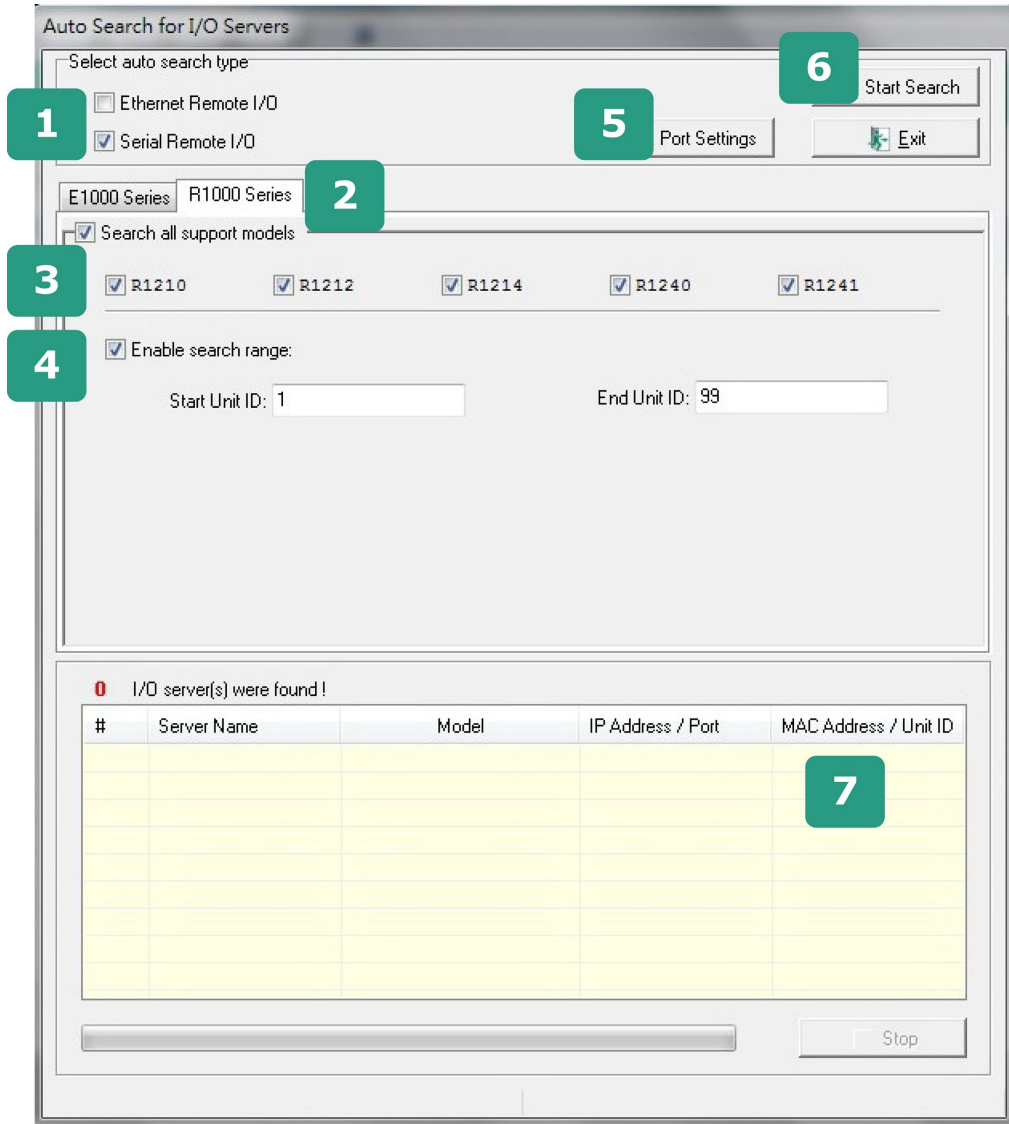

Steps to Search for an ioLogik R1200 device:

1. Select the “RS-232/485 Remote I/O” checkbox.
2. Select the “R1000 Series” tab.
3. Select the ioLogik R1200 model(s) for which you are searching.
4. Click and Select “Enable search range” and enter the unit ID number, which ranges from 1 to 99.
5. Click the **Port Settings** button to configure, set, or verify the serial port settings. Select specific COM ports under “Only Search”, or select “Search All System Com Ports” to configure COM port settings, the Modbus protocol, and timeout interval.

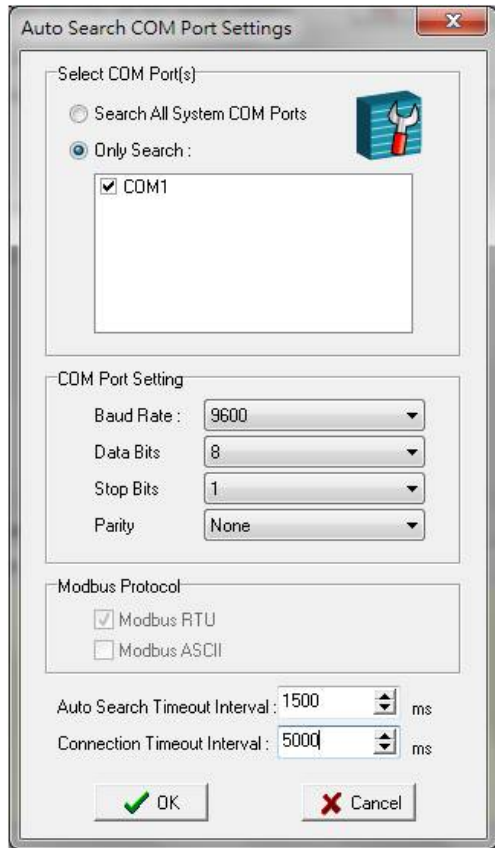

Auto Search Timeout Interval: The timeout interval sets the preferred waiting time for an ioLogik R1200 device to respond to a search. After exceeding the preset time limit, ioSearch will proceed to the next device on the network.

Connection Timeout Interval: The timeout interval sets the preferred waiting time for an ioLogik R1200 device to respond before it disconnects. After exceeding the preset time limit, ioSearch will disconnect the ioLogik R1200 device.

- When you click **Start Search**, ioSearch will begin searching up to 99 IDs for your ioLogik unit. The timeout interval is for RS-485 communication and defaults to 2,000 ms. As soon as your screen looks like the figure below, click **Stop**. Otherwise, ioSearch will continue to search all 99 ports.

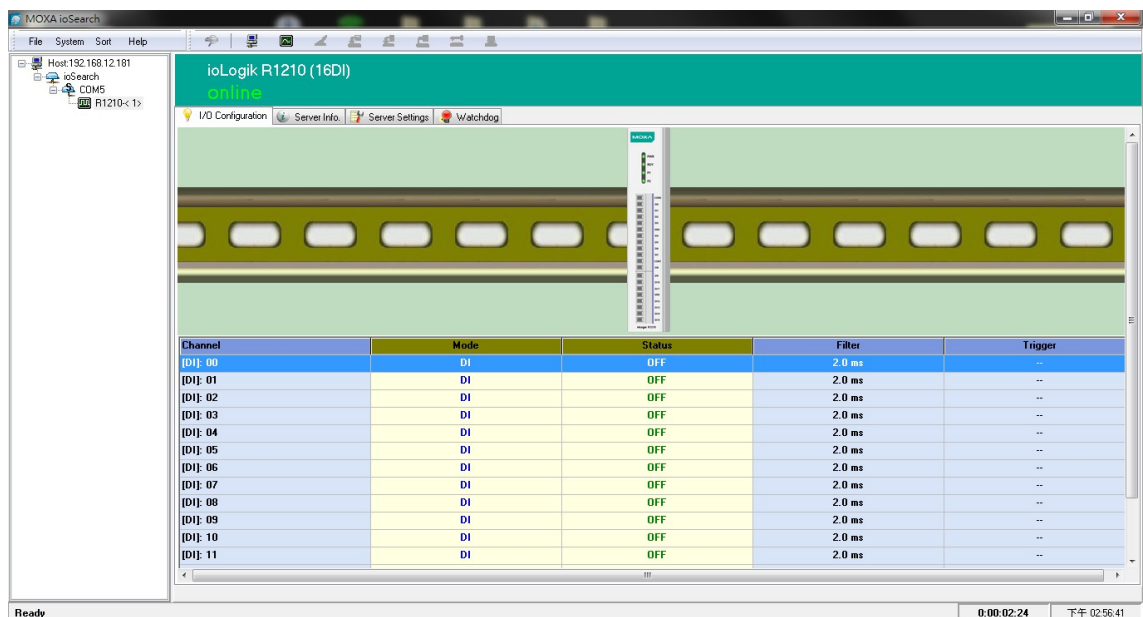

Once the ioLogik R1200 device has been discovered by the ioSearch utility, you will be able to monitor the I/O status from the first tab of the ioSearch utility. You will also be able to configure each DI and DO channel from this tab after first logging in under the **Management** tab.



ATTENTION

If ioSearch is unable to find your ioLogik R1200 device, confirm that the device ID matches the correct ioLogik device. See the previous section for setting or viewing the device ID.

Auto Search Timeout allows users to set the timeout value for TCP socket communication, but only for Ethernet remote I/O devices.

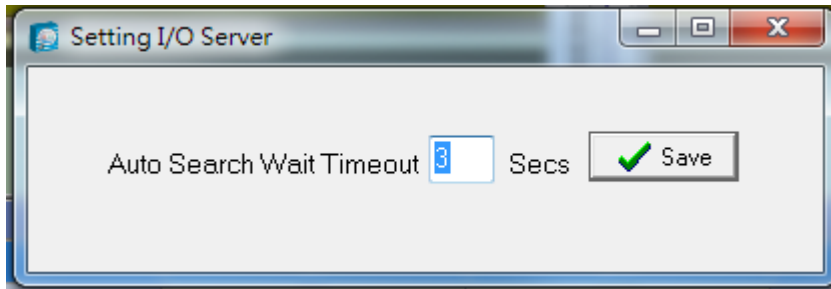

I/O Status Refresh Rate is used to adjust how often the I/O server is polled for device status. The current rate is displayed on the status bar at the bottom of the window. Note that higher sync rates result in higher loads on the network.

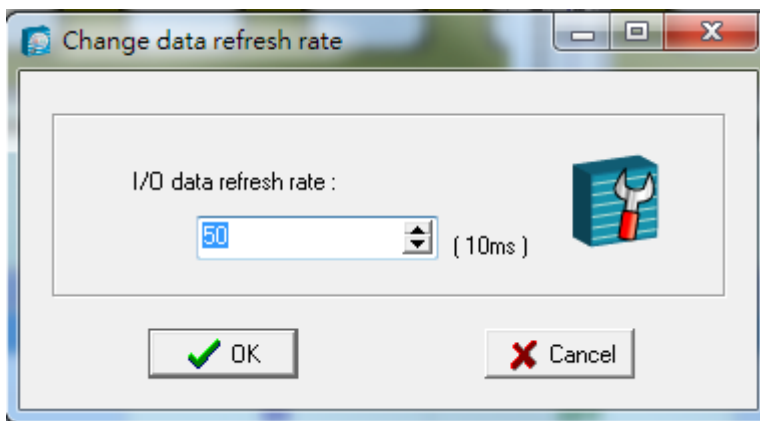

Sort

The **Sort** menu allows the server list in the navigation panel to be sorted by ioLogik connection and server model.

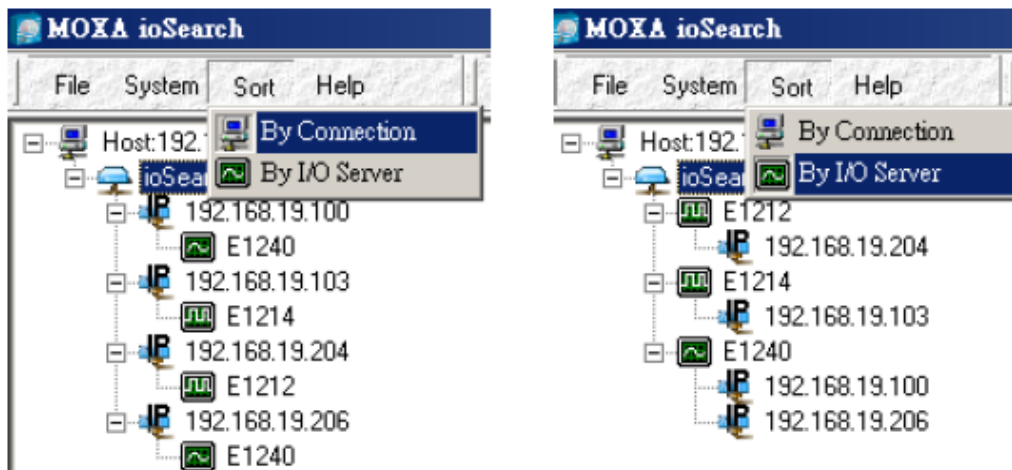

Help

In the **Help** menu, you can view vendor and version information.

Quick Links

Quick links are provided to search for I/O servers on the RS-485 network and sort the server list.



1. Automatically searches the local network
2. Sorts by ioLogik R1200 device ID ("By Connection")
3. Sorts by ioLogik R1200 model number ("By I/O Server")

Main Functions

Right click on a particular ioLogik R1200 device to view the ioSearch function menu.

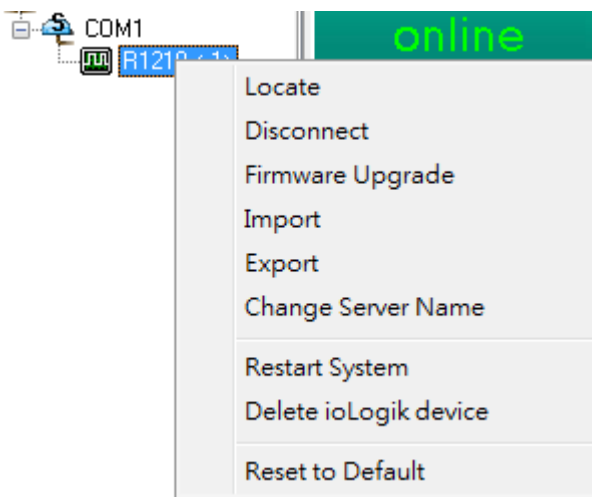

Locate

The locate function helps users find a specific ioLogik on the network. When this function is triggered, the ready LED on the selected unit will start to blink, indicating its location.

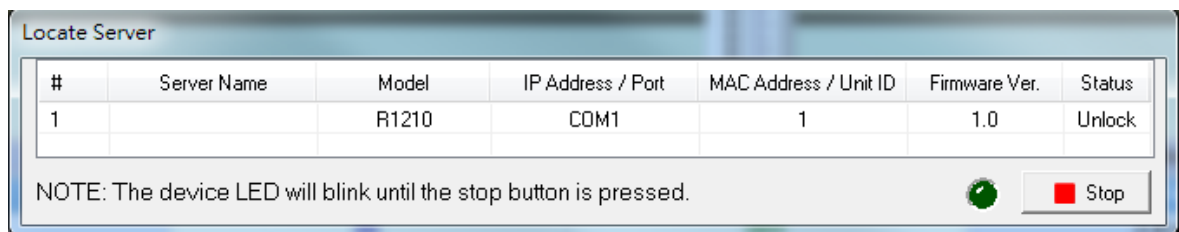

Connect/Disconnect

The Connect/Disconnect function connects or disconnects the ioLogik device from the ioSearch network.

Firmware Upgrade

The ioLogik R1200 supports a remote firmware upgrade function. Enter the path of the firmware file or click on the icon to browse for the file. The wizard will lead you through the process until the server restarts.

Import

Select this command to reload a configuration that was exported to a text file. You will need to restart the ioLogik in order for the new configuration to take effect. This command may be used to restore a configuration after loading the factory defaults, or to duplicate a configuration to multiple ioLogik units.

#	Server Name	Model	IP Address / ...	MAC Address / U...	Subnet Mask	Gateway	Firmware...	Status
1		R1210	COM1				1.0	Unlock

Locate
 Disconnect
 Firmware Upgrade
Import
 Export
 Change Server Name

Export

Select this command to export the configuration of the ioLogik to a text file. You will need to log in as an administrator to use this function. It is strongly recommended you use this method to back up your configuration after you have finished configuring the ioLogik for your application.

Change Server Name

The Change Server name function can be used to directly modify the Server Name, especially for first time installation.

Changing the Server Name for multiple ioLogik R1200 devices is allowed. Select the ioLogik R1200 and then right click to process this function. After entering the desired server name, click Submit to apply changes.

Change Server Name

#	Server Name	Model	IP Address / Port	MAC Address / Unit ID	Firmware Ver.	Status	Change Server Name
*1	ioLogik.R1210.COM1	R1210	COM1	1	1.0	Unlock	

Restart System

Select this command to restart the selected ioLogik R1200 device.

Restart multiple ioLogik R1200 units by right-clicking on an ioLogik R1200 and selecting this function.

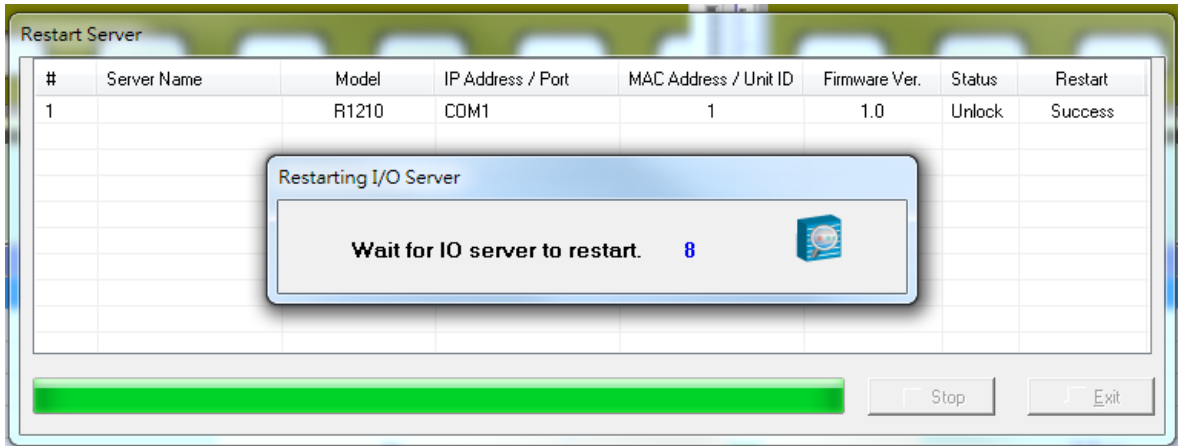

Delete ioLogik Device

Select this function to remove an ioLogik R1200 unit from the tree manually.

Reset to Default

Select this function to reset all settings, including console passwords, to factory default values.

Reset multiple ioLogik R1200 units to default configurations by right-clicking the ioLogik R1200 and selecting this function.

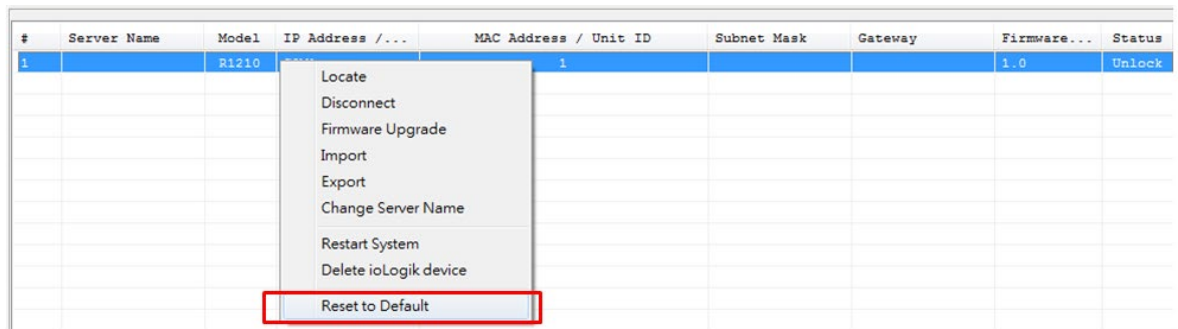

Main Screen

I/O Configuration Tab (General)

The **I/O Configuration** tab shows the status of every I/O channel. This is the default tab when you first open ioSearch.

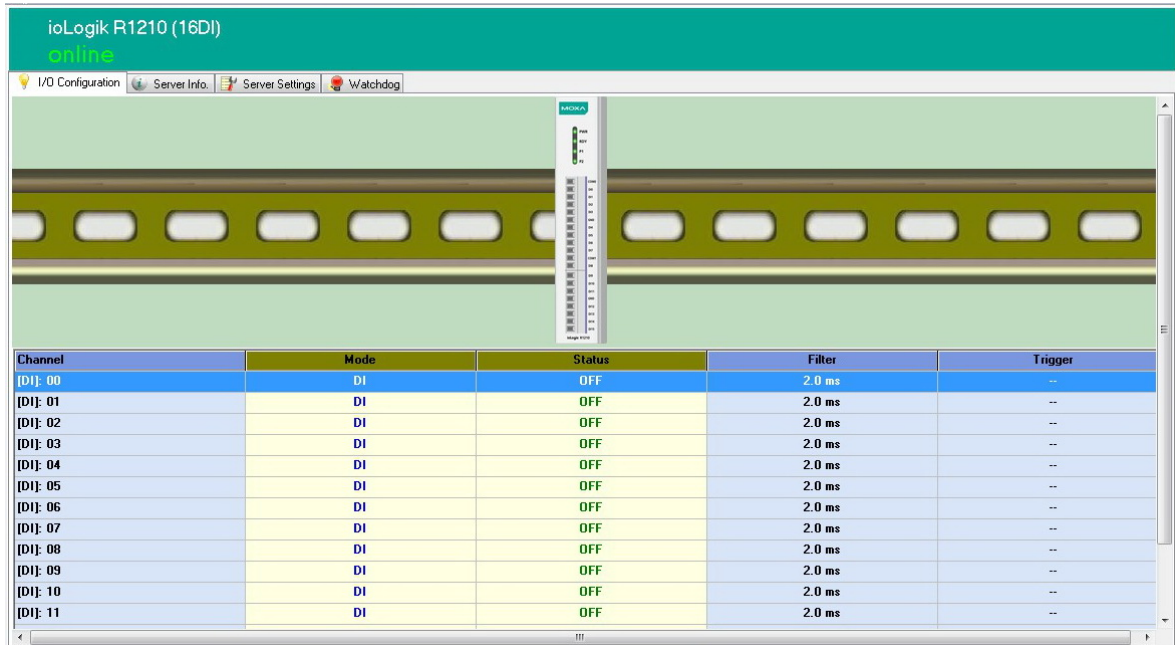

Configuring Digital Input Channels

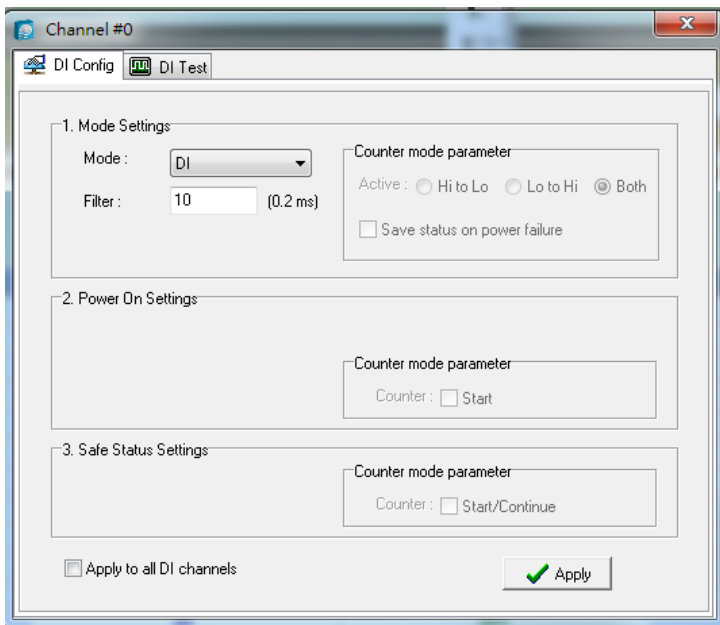

The ioLogik R1200’s digital channel can be separately set to “DI” or “Event Counter Mode.” In “DI” mode, the specifications are as follows:

Type	Logic 0 (OFF)	Logic 1 (ON)
Dry contact	Open	Close to GND
Wet contact (DI to COM)	0 to 3 V	10 to 30 V

In "Event Counter" mode, the ioLogik R1200's DI channel accepts data from limit or proximity switches, and counts events according to the ON/OFF status. You may select from two modes, "Lo to Hi" or "Hi to Lo." When "Lo to Hi" is selected, the counter value increases while the switch is pushed. When "Hi to Lo" is selected, the counter value increases when the switch is pushed and released. The sampling rate of the counter is 2.5 kHz. This function is designed for low speed switching, not for motor control.

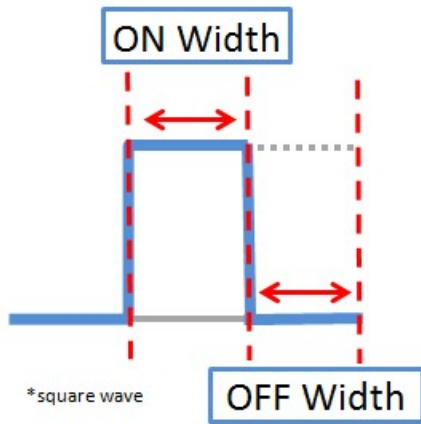

To eliminate the problem of switch bouncing, the ioLogik R1200 provides software filtering that is configurable in multiples of 0.2 ms. For example, a setting of 100 would mean a 20 ms filter (100 × 0.2 ms). The maximum value allowed by the software filter is 65535. Setting the filter to "0" causes the system to filter all signals.

Power On Settings: You may configure DI channels in Event Counter mode whether or not counting begins when powering up.

Safe Status Settings: For DI channels in Event Counter mode, you can configure whether or not counting starts or continues when Safe Status has been activated. When the network connection is lost as specified in the Host Connection Watchdog, the ioLogik R1200 will start or stop the counter according to the channel's Safe Status settings. Note that the Host Connection Watchdog is disabled by default, and must be enabled for Safe Status settings to take effect.

Test I/O: You can test DI channels in the **Test** tab to see how the status or counter value responds when the attached input device is manipulated.

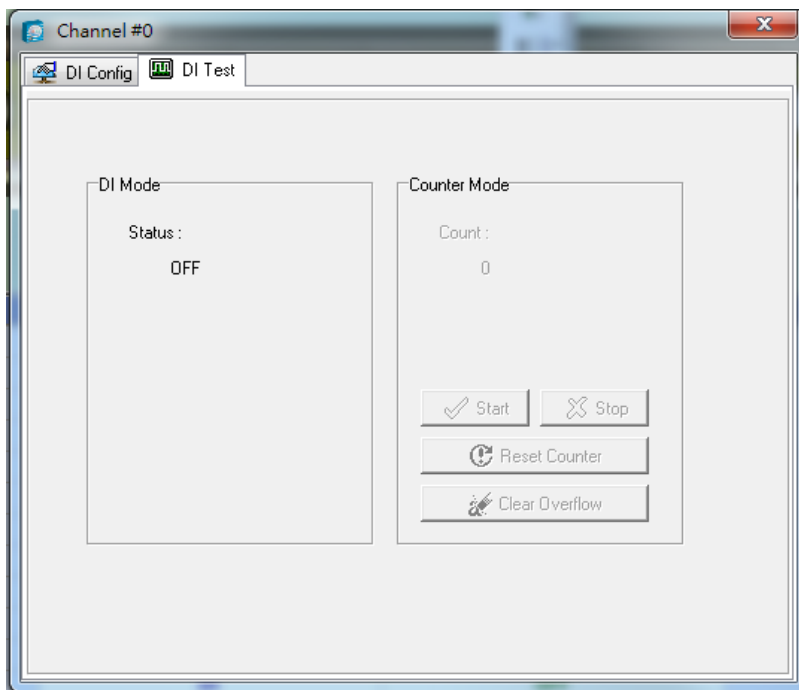

Configuring Digital Output Channels



Each ioLogik R1200 digital output channel can be set to “DO” or “Pulse Output” mode. In DO mode, the specifications are as follows.

Type	Logic 0 (OFF)	Logic 1 (ON)
DO mode	Open	Short

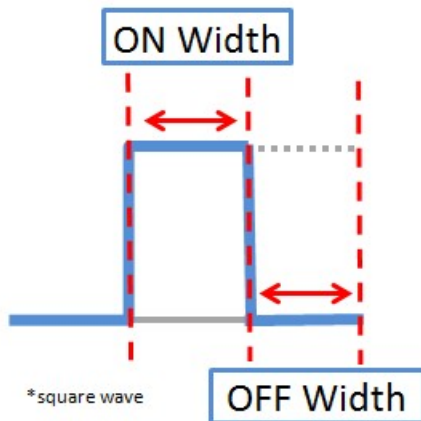

In “Pulse Output” mode, the selected digital output channel will generate a square wave as specified in the pulse mode parameters. The Low and High parameters are in multiples of 0.1 ms, with a maximum setting of 65535. To set the low level width for 5 ms, you would enter 50 (because $50 \times 0.1 \text{ ms} = 5 \text{ ms}$). A setting of **100** for both Low and High would generate a square wave with a 20 ms cycle. The **Output** parameter specifies the number of pulses to send. When set to **0**, the system will send pulses continuously.



Power On Settings: Use this field to set the initial status for the DO channel when the ioLogik is powered on.

Safe Status Settings: Use this field to specify how the DO channel responds to a break in network communication. When the network connection is lost as specified in the Host Connection Watchdog, the ioLogik R1200 will reset all channels according to their Safe Status settings. Note that the Host Connection Watchdog is disabled by default, and must be enabled for Safe Status settings to have effect.

Test I/O: You can test the DO channel in the **Test** tab.

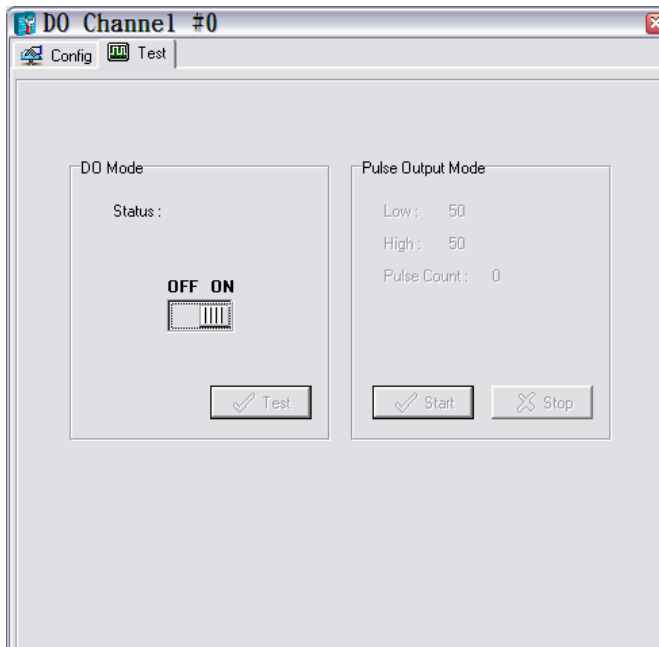

Configuring Analog Input Channels

The current status of each AI (analog input) channel can be viewed on the I/O Setting:

Click on a specific channel to enable or disable the AI channel by selecting the **“Enable AI Channel”** field.

There are two modes for the AI channels:

1. **AI Input: Voltage Mode (V)** (See Chapter 2, **Jumper Settings (DIO and AI)**, for more information)

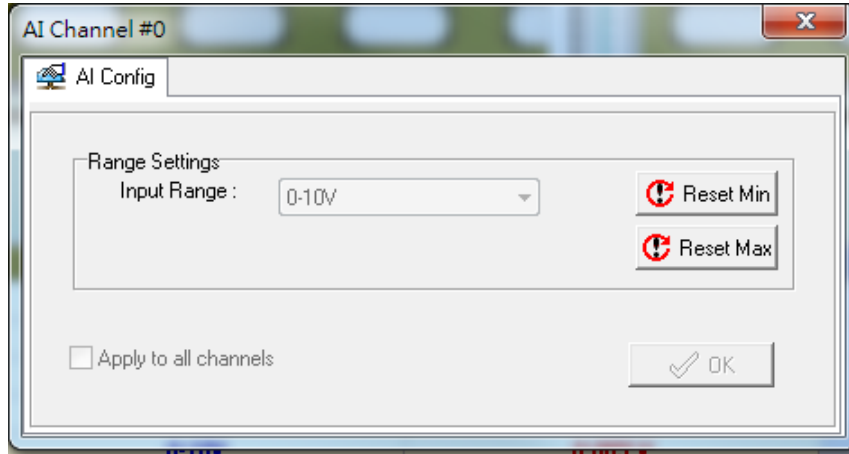

2. **AI Input: Current Mode (mA)** (See Chapter 2, **Jumper Settings (DIO and AI)**, for more information)

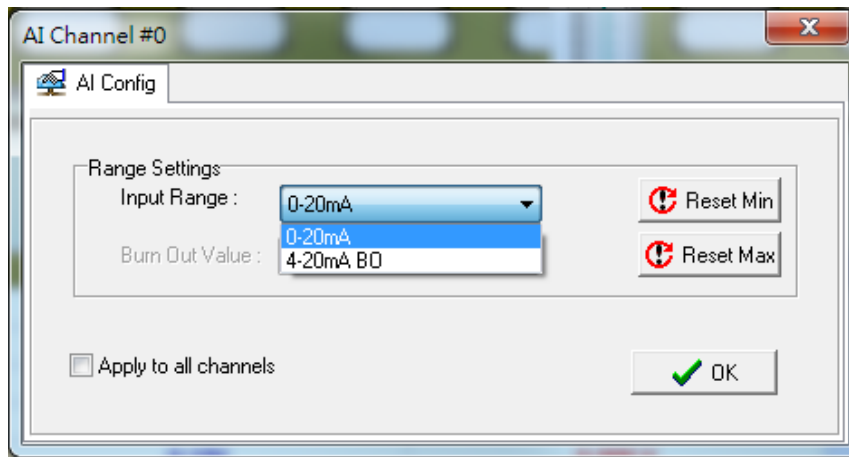

AI Input Range

Set the AI input ranges for each mode, as follows:

1. **AI Input: Voltage Mode (V)** (See **Jumper Settings (DIO and AI)** in Chapter 2 for more information)

There is only one default analog “voltage” input range: [0-10V]

2. **AI Input: Current Mode (mA)** (See **Jumper Settings (DIO and AI)** in Chapter 2 for more information)

There are two modes in the analog “current” input range: [0-20 mA], [4-20 mA (burnout)]

Burnout mode indicates if the current analog input has burned out. For example, the 4–20 mA burnout mode is defined in the following diagram:

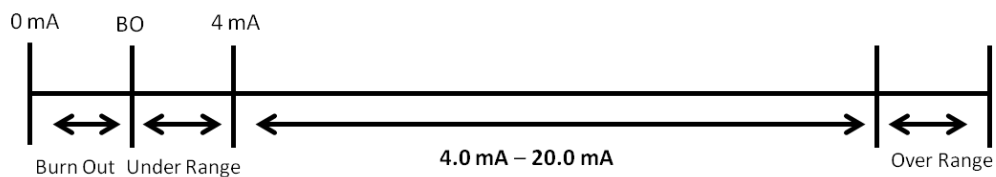

Users can define burnout values (BO, default 2 mA) for selected ranges. When input values are in the burnout range, raw data will register as 0000h to indicate analog input burnout. The definition of raw data is as follows:

Burnout Value (BO)	$0.0 < BO < 4.0$	User defined (default 2 mA)
Burnout State	$0 \leq AI < BO \text{ mA}$	S/W output 0000h
Under Range	$BO \leq AI < 4 \text{ mA}$	S/W output raw data
Normal Range	$4 \leq AI \leq 20.00 \text{ mA}$	S/W output raw data until FFEh
Over Range	$XX > 20.00 \text{ mA}$	S/W output FFFFh

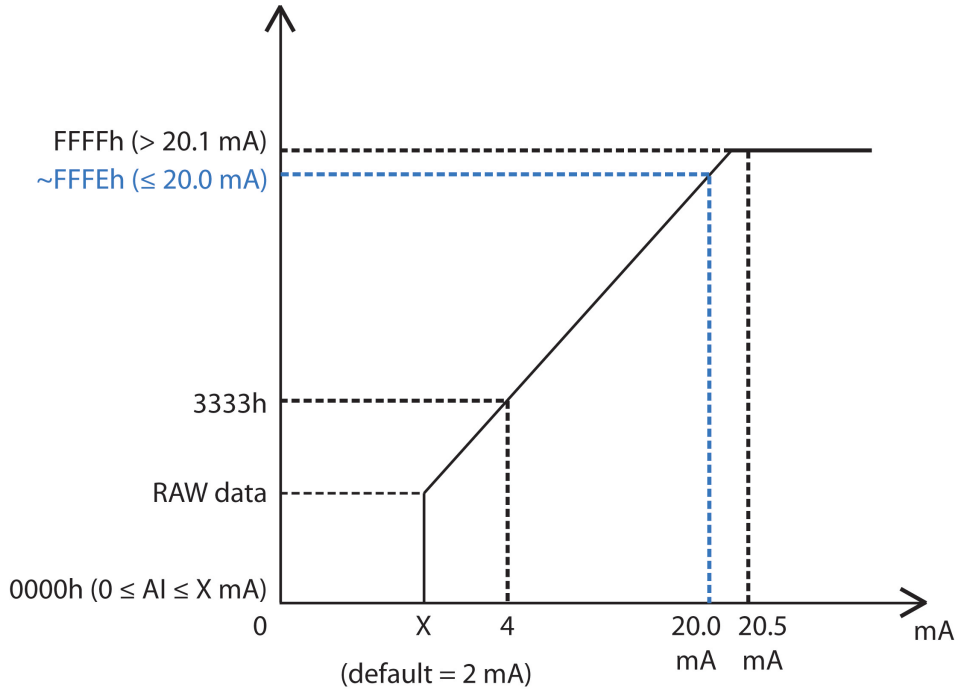

ATTENTION

When configuring the jumpers to select voltage or current measurement for the AI channels, open the cover by first removing the screw on the back panel. Details on jumper settings can be found in the **Jumper Settings (DIO and AI)** section.

Configuring Analog Output Channels

The current status of each AO (analog output) channel can be viewed on the I/O Setting:

Channel	Range	Value
[AO]: 00	0-10V	0.000 V
[AO]: 01	0-10V	0.000 V
[AO]: 02	0-10V	0.000 V
[AO]: 03	0-10V	0.000 V

Click on a specific channel to access the AO channel settings.

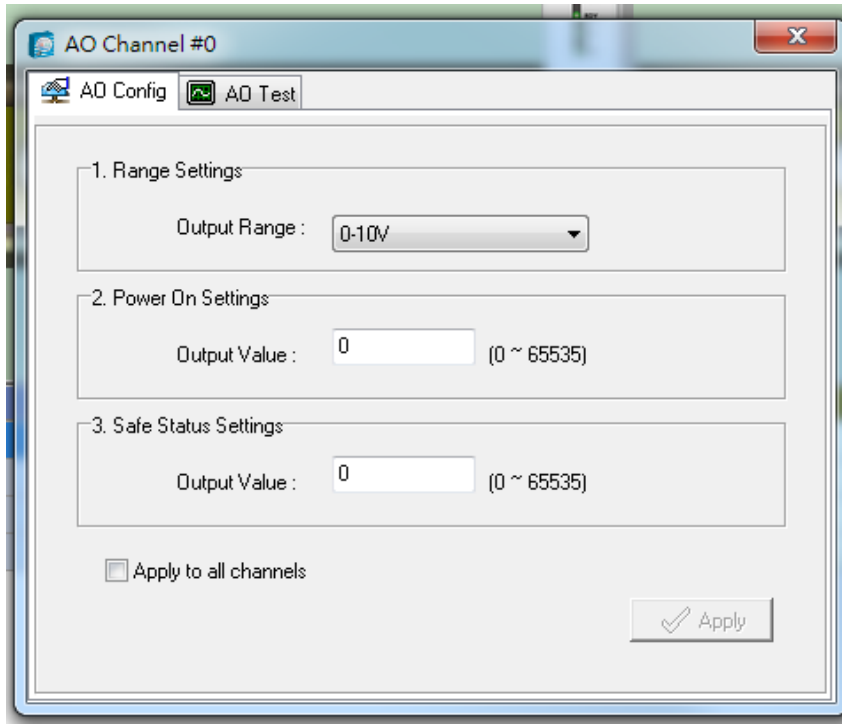

There are two modes for the AI channels, **Voltage Mode (V)** and **Current Mode (mA)**. See **Jumper Settings (DIO and AI)** in Chapter 2 for more information.

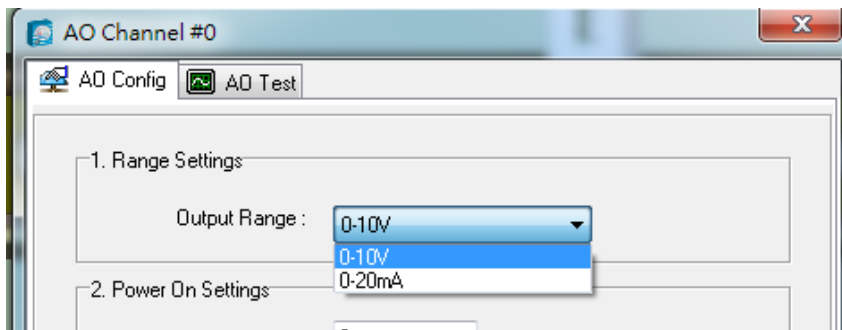

Power On Settings: For AO channels in Event Counter mode, you may configure whether or not counting begins at power up.

Safe Status Settings: For AO channels in Event Counter mode, you can configure whether or not counting starts or continues when Safe Status has been activated. When the network connection is lost as specified in the Host Connection Watchdog, the ioLogik R1200 will start or stop the counter according to the channel's Safe Status settings. Note that the Host Connection Watchdog is disabled by default, and must be enabled for Safe Status settings to have effect.

Test I/O: You can test AO channels in the **Test** tab. You may see how the status or counter value responds when the attached input device is manipulated.

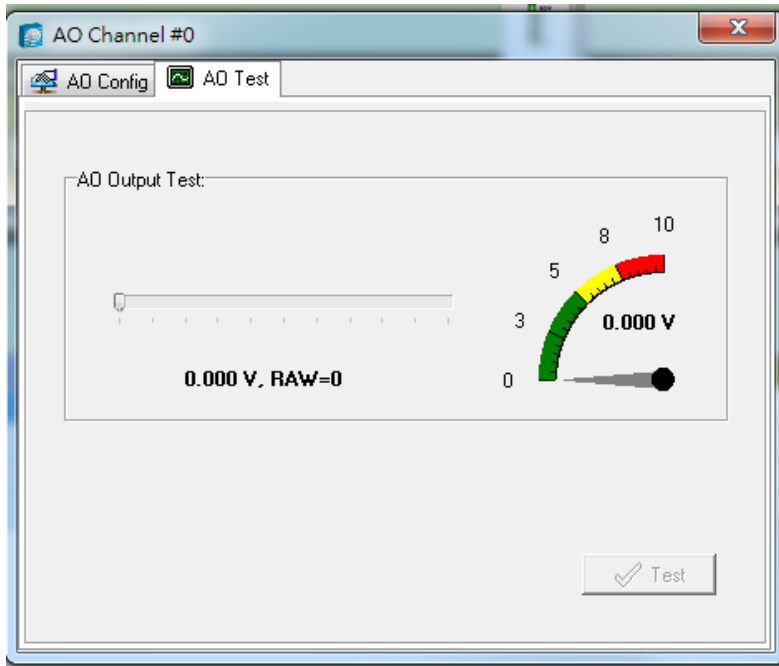

Server Info Tab

The **Server Information** tab provides the Modbus addresses for all system configurations. This helps you verify the access authority of each address. The screen also displays a clear explanation of each item.

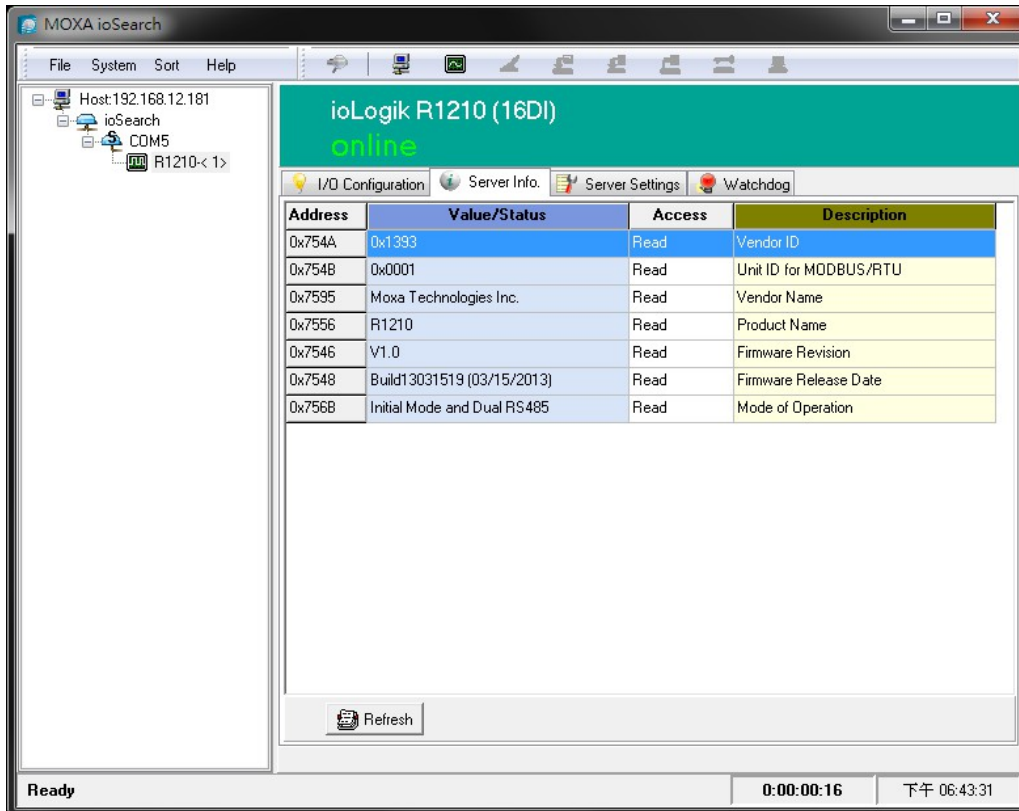

Server Settings Tab (General)

The **Server Settings** tab is where you log in as an administrator. This is required in order to gain access to the ioLogik R1200 configuration options. If no administrator password has been set up, simply click on **Login** and leave the **Password for entry** field blank. Additional information on ioSearch administrator functions is provided later in this chapter.

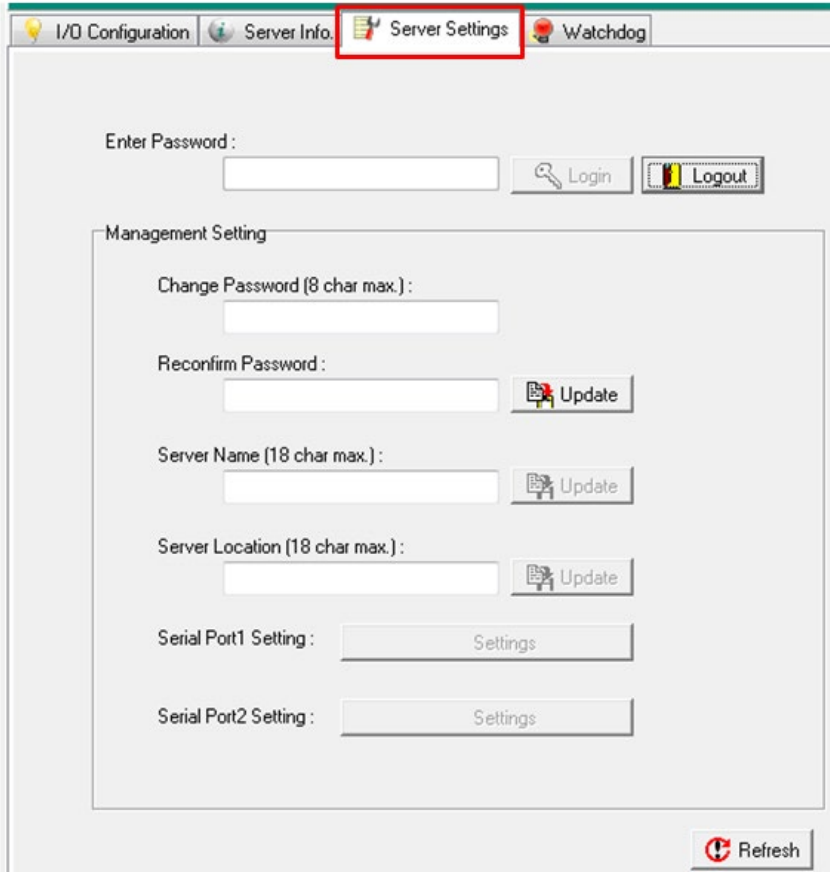

Click "Serial Port1 Setting" or "Serial Port2 Setting" to define and set the serial communication ports.

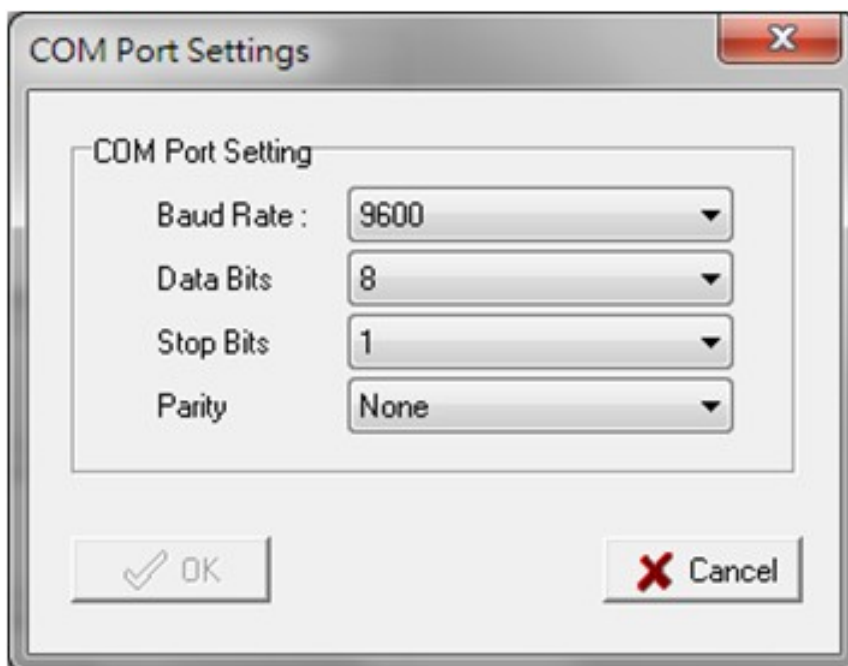

Watchdog

The **Watchdog** tab is where you configure the Host Connection Watchdog, which is used with the Safe Status settings to define each channel's response to a lost connection. When the ioLogik R1200 loses its connection as specified in the timeout, the Host Connection Watchdog will switch the ioLogik R1200 to Safe Status and all channels will reset to their Safe Status settings. By default, the Watchdog is disabled. To enable the Watchdog, make sure **Enable Host Connection Watchdog** is checked, set the Timeout value, then click the **Update** button.

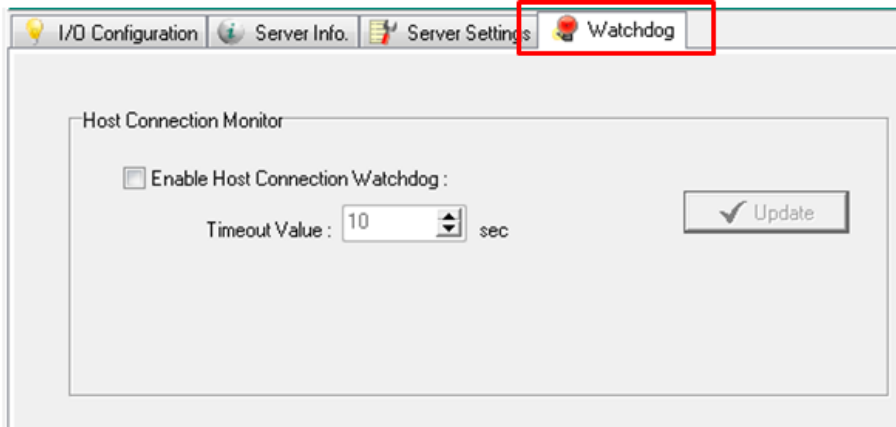

After the Watchdog is enabled, the ioLogik R2110 will enter safe status if the RS-485 connection is lost. Once the connection has been restored, you will need to return to the Watchdog tab in order to exit Safe Status.

There will be a message saying "Host Connection Lost" to indicate that the server is in safe status. Click **Clear Alarm** to exit safe status and return to normal operation.

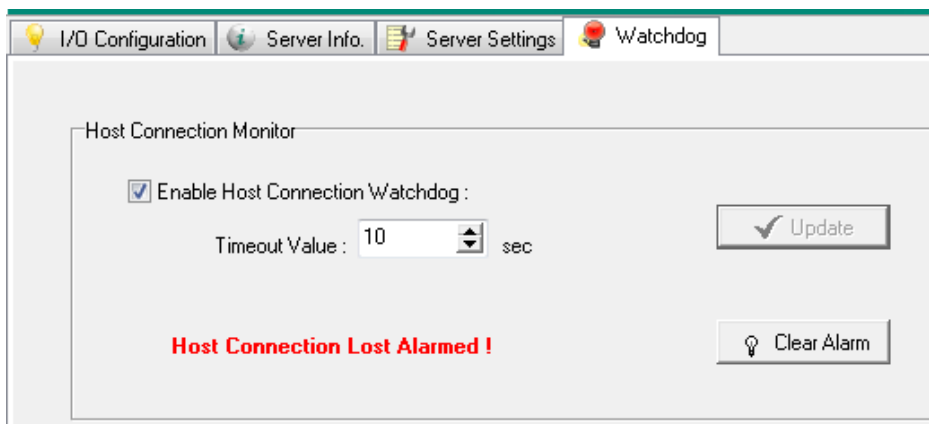

Modbus Mapping

The following topics are covered in this appendix:

□ R1210 Modbus Mapping

- 0xxxx Read/Write Coils (Functions 1, 5, 15)
- 1xxxx Read Only Coils (Function 2)
- 3xxxx Read Only Registers (Function 4)
- 4xxxx Read/Write Registers (Functions 3, 6, 16)

□ R1212 Modbus Mapping

- 0xxxx Read/Write Coils (Functions 1, 5, 15)
- 1xxxx Read Only Coils (Function 2)
- 3xxxx Read Only Registers (Function 4)
- 4xxxx Read/Write Registers (Functions 3, 6, 16)

□ R1214 Modbus Mapping

- 0xxxx Read/Write Coils (Functions 1, 5, 15)
- 1xxxx Read Only Coils (Function 2)
- 3xxxx Read Only Registers (Function 4)
- 4xxxx Read/Write Registers (Functions 3, 6, 16)

□ R1240 Modbus Mapping

- 0xxxx Read/Write Coils (Functions 1, 5, 15)
- 3xxxx Read Only Registers (Function 4)
- 4xxxx Read/Write Registers (Functions 3, 6, 16)

□ R1241 Modbus Mapping

- 4xxxx Read/Write Registers (Functions 3, 6, 16)

R1210 Modbus Mapping

0xxxx Read/Write Coils (Functions 1, 5, 15)

Reference	Address	Data Type	Description
00001	0x0000	1Bit	CH0 DI Counter start, 0=OFF, 1=ON
00002	0x0001	1Bit	CH1 DI Counter start, 0=OFF, 1=ON
00003	0x0002	1Bit	CH2 DI Counter start, 0=OFF, 1=ON
00004	0x0003	1Bit	CH3 DI Counter start, 0=OFF, 1=ON
00005	0x0004	1Bit	CH4 DI Counter start, 0=OFF, 1=ON
00006	0x0005	1Bit	CH5 DI Counter start, 0=OFF, 1=ON
00007	0x0006	1Bit	CH6 DI Counter start, 0=OFF, 1=ON
00008	0x0007	1Bit	CH7 DI Counter start, 0=OFF, 1=ON
00009	0x0008	1Bit	CH8 DI Counter start, 0=OFF, 1=ON
00010	0x0009	1Bit	CH9 DI Counter start, 0=OFF, 1=ON
00011	0x000A	1Bit	CH10 DI Counter start, 0=OFF, 1=ON
00012	0x000B	1Bit	CH11 DI Counter start, 0=OFF, 1=ON
00013	0x000C	1Bit	CH12 DI Counter start, 0=OFF, 1=ON
00014	0x000D	1Bit	CH13 DI Counter start, 0=OFF, 1=ON
00015	0x000E	1Bit	CH14 DI Counter start, 0=OFF, 1=ON
00016	0x000F	1Bit	CH15 DI Counter start, 0=OFF, 1=ON
00033	0x0020	1Bit	CH0 DI Counter reset, 0=no effect, 1=reset
00034	0x0021	1Bit	CH1 DI Counter reset, 0=no effect, 1=reset
00035	0x0022	1Bit	CH2 DI Counter reset, 0=no effect, 1=reset
00036	0x0023	1Bit	CH3 DI Counter reset, 0=no effect, 1=reset
00037	0x0024	1Bit	CH4 DI Counter reset, 0=no effect, 1=reset
00038	0x0025	1Bit	CH5 DI Counter reset, 0=no effect, 1=reset
00039	0x0026	1Bit	CH6 DI Counter reset, 0=no effect, 1=reset
00040	0x0027	1Bit	CH7 DI Counter reset, 0=no effect, 1=reset
00041	0x0028	1Bit	CH8 DI Counter reset, 0=no effect, 1=reset
00042	0x0029	1Bit	CH9 DI Counter reset, 0=no effect, 1=reset
00043	0x002A	1Bit	CH10 DI Counter reset, 0=no effect, 1=reset
00044	0x002B	1Bit	CH11 DI Counter reset, 0=no effect, 1=reset
00045	0x002C	1Bit	CH12 DI Counter reset, 0=no effect, 1=reset
00046	0x002D	1Bit	CH13 DI Counter reset, 0=no effect, 1=reset
00047	0x002E	1Bit	CH14 DI Counter reset, 0=no effect, 1=reset
00048	0x002F	1Bit	CH15 DI Counter reset, 0=no effect, 1=reset
00065	0x0040	1Bit	CH0 DI Counter overflow, 0=no effect, 1=overflow
00066	0x0041	1Bit	CH1 DI Counter overflow, 0=no effect, 1=overflow
00067	0x0042	1Bit	CH2 DI Counter overflow, 0=no effect, 1=overflow
00068	0x0043	1Bit	CH3 DI Counter overflow, 0=no effect, 1=overflow
00069	0x0044	1Bit	CH4 DI Counter overflow, 0=no effect, 1=overflow
00070	0x0045	1Bit	CH5 DI Counter overflow, 0=no effect, 1=overflow
00071	0x0046	1Bit	CH6 DI Counter overflow, 0=no effect, 1=overflow
00072	0x0047	1Bit	CH7 DI Counter overflow, 0=no effect, 1=overflow
00073	0x0048	1Bit	CH8 DI Counter overflow, 0=no effect, 1=overflow
00074	0x0049	1Bit	CH9 DI Counter overflow, 0=no effect, 1=overflow
00075	0x004A	1Bit	CH10 DI Counter overflow, 0=no effect, 1=overflow
00076	0x004B	1Bit	CH11 DI Counter overflow, 0=no effect, 1=overflow
00077	0x004C	1Bit	CH12 DI Counter overflow, 0=no effect, 1=overflow
00078	0x004D	1Bit	CH13 DI Counter overflow, 0=no effect, 1=overflow

Reference	Address	Data Type	Description
00079	0x004E	1Bit	CH14 DI Counter overflow, 0=no effect, 1=overflow
00080	0x004F	1Bit	CH15 DI Counter overflow, 0=no effect, 1=overflow
00097	0x0060	1Bit	CH0 DI Power on counter start, 0=OFF, 1=ON
00098	0x0061	1Bit	CH1 DI Power on counter start, 0=OFF, 1=ON
00099	0x0062	1Bit	CH2 DI Power on counter start, 0=OFF, 1=ON
00100	0x0063	1Bit	CH3 DI Power on counter start, 0=OFF, 1=ON
00101	0x0064	1Bit	CH4 DI Power on counter start, 0=OFF, 1=ON
00102	0x0065	1Bit	CH5 DI Power on counter start, 0=OFF, 1=ON
00103	0x0066	1Bit	CH6 DI Power on counter start, 0=OFF, 1=ON
00104	0x0067	1Bit	CH7 DI Power on counter start, 0=OFF, 1=ON
00105	0x0068	1Bit	CH8 DI Power on counter start, 0=OFF, 1=ON
00106	0x0069	1Bit	CH9 DI Power on counter start, 0=OFF, 1=ON
00107	0x006A	1Bit	CH10 DI Power on counter start, 0=OFF, 1=ON
00108	0x006B	1Bit	CH11 DI Power on counter start, 0=OFF, 1=ON
00109	0x006C	1Bit	CH12 DI Power on counter start, 0=OFF, 1=ON
00110	0x006D	1Bit	CH13 DI Power on counter start, 0=OFF, 1=ON
00111	0x006E	1Bit	CH14 DI Power on counter start, 0=OFF, 1=ON
00112	0x006F	1Bit	CH15 DI Power on counter start, 0=OFF, 1=ON
00129	0x0080	1Bit	CH0 DI Safe mode counter start, 0=OFF, 1=ON
00130	0x0081	1Bit	CH1 DI Safe mode counter start, 0=OFF, 1=ON
00131	0x0082	1Bit	CH2 DI Safe mode counter start, 0=OFF, 1=ON
00132	0x0083	1Bit	CH3 DI Safe mode counter start, 0=OFF, 1=ON
00133	0x0084	1Bit	CH4 DI Safe mode counter start, 0=OFF, 1=ON
00134	0x0085	1Bit	CH5 DI Safe mode counter start, 0=OFF, 1=ON
00135	0x0086	1Bit	CH6 DI Safe mode counter start, 0=OFF, 1=ON
00136	0x0087	1Bit	CH7 DI Safe mode counter start, 0=OFF, 1=ON
00137	0x0088	1Bit	CH8 DI Safe mode counter start, 0=OFF, 1=ON
00138	0x0089	1Bit	CH9 DI Safe mode counter start, 0=OFF, 1=ON
00139	0x008A	1Bit	CH10 DI Safe mode counter start, 0=OFF, 1=ON
00140	0x008B	1Bit	CH11 DI Safe mode counter start, 0=OFF, 1=ON
00141	0x008C	1Bit	CH12 DI Safe mode counter start, 0=OFF, 1=ON
00142	0x008D	1Bit	CH13 DI Safe mode counter start, 0=OFF, 1=ON
00143	0x008E	1Bit	CH14 DI Safe mode counter start, 0=OFF, 1=ON
00144	0x008F	1Bit	CH15 DI Safe mode counter start, 0=OFF, 1=ON
00161	0x00A0	1Bit	CH0 DI power failing counter storage, 0=OFF, 1=ON
00162	0x00A1	1Bit	CH1 DI power failing counter storage, 0=OFF, 1=ON
00163	0x00A2	1Bit	CH2 DI power failing counter storage, 0=OFF, 1=ON
00164	0x00A3	1Bit	CH3 DI power failing counter storage, 0=OFF, 1=ON
00165	0x00A4	1Bit	CH4 DI power failing counter storage, 0=OFF, 1=ON
00166	0x00A5	1Bit	CH5 DI power failing counter storage, 0=OFF, 1=ON
00167	0x00A6	1Bit	CH6 DI power failing counter storage, 0=OFF, 1=ON
00168	0x00A7	1Bit	CH7 DI power failing counter storage, 0=OFF, 1=ON
00169	0x00A8	1Bit	CH8 DI power failing counter storage, 0=OFF, 1=ON
00170	0x00A9	1Bit	CH9 DI power failing counter storage, 0=OFF, 1=ON
00171	0x00AA	1Bit	CH10 DI power failing counter storage, 0=OFF, 1=ON
00172	0x00AB	1Bit	CH11 DI power failing counter storage, 0=OFF, 1=ON
00173	0x00AC	1Bit	CH12 DI power failing counter storage, 0=OFF, 1=ON
00174	0x00AD	1Bit	CH13 DI power failing counter storage, 0=OFF, 1=ON
00175	0x00AE	1Bit	CH14 DI power failing counter storage, 0=OFF, 1=ON
00176	0x00AF	1Bit	CH15 DI power failing counter storage, 0=OFF, 1=ON

1xxxx Read Only Coils (Function 2)

Reference	Address	Data Type	Description
10001	0x0000	1Bit	CH0 DI Bit value, 0=OFF, 1=ON
10002	0x0001	1Bit	CH1 DI Bit value, 0=OFF, 1=ON
10003	0x0002	1Bit	CH2 DI Bit value, 0=OFF, 1=ON
10004	0x0003	1Bit	CH3 DI Bit value, 0=OFF, 1=ON
10005	0x0004	1Bit	CH4 DI Bit value, 0=OFF, 1=ON
10006	0x0005	1Bit	CH5 DI Bit value, 0=OFF, 1=ON
10007	0x0006	1Bit	CH6 DI Bit value, 0=OFF, 1=ON
10008	0x0007	1Bit	CH7 DI Bit value, 0=OFF, 1=ON
10009	0x0008	1Bit	CH8 DI Bit value, 0=OFF, 1=ON
10010	0x0009	1Bit	CH9 DI Bit value, 0=OFF, 1=ON
10011	0x000A	1Bit	CH10 DI Bit value, 0=OFF, 1=ON
10012	0x000B	1Bit	CH11 DI Bit value, 0=OFF, 1=ON
10013	0x000C	1Bit	CH12 DI Bit value, 0=OFF, 1=ON
10014	0x000D	1Bit	CH13 DI Bit value, 0=OFF, 1=ON
10015	0x000E	1Bit	CH14 DI Bit value, 0=OFF, 1=ON
10016	0x000F	1Bit	CH15 DI Bit value, 0=OFF, 1=ON

3xxxx Read Only Registers (Function 4)

Reference	Address	Data Type	Description
30001	0x0000	1 Word	CH0 DI value, 0=OFF, 1=ON
30002	0x0001	1 Word	CH1 DI value, 0=OFF, 1=ON
30003	0x0002	1 Word	CH2 DI value, 0=OFF, 1=ON
30004	0x0003	1 Word	CH3 DI value, 0=OFF, 1=ON
30005	0x0004	1 Word	CH4 DI value, 0=OFF, 1=ON
30006	0x0005	1 Word	CH5 DI value, 0=OFF, 1=ON
30007	0x0006	1 Word	CH6 DI value, 0=OFF, 1=ON
30008	0x0007	1 Word	CH7 DI value, 0=OFF, 1=ON
30009	0x0008	1 Word	CH8 DI value, 0=OFF, 1=ON
30010	0x0009	1 Word	CH9 DI value, 0=OFF, 1=ON
30011	0x000A	1 Word	CH10 DI value, 0=OFF, 1=ON
30012	0x000B	1 Word	CH11 DI value, 0=OFF, 1=ON
30013	0x000C	1 Word	CH12 DI value, 0=OFF, 1=ON
30014	0x000D	1 Word	CH13 DI value, 0=OFF, 1=ON
30015	0x000E	1 Word	CH14 DI value, 0=OFF, 1=ON
30016	0x000F	1 Word	CH15 DI value, 0=OFF, 1=ON
30033	0x0020	2 Word	CH0 DI counter value
30035	0x0022	2 Word	CH1 DI counter value
30037	0x0024	2 Word	CH2 DI counter value
30039	0x0026	2 Word	CH3 DI counter value
30041	0x0028	2 Word	CH4 DI counter value
30043	0x002A	2 Word	CH5 DI counter value
30045	0x002C	2 Word	CH6 DI counter value
30047	0x002E	2 Word	CH7 DI counter value
30049	0x0030	2 Word	CH8 DI counter value
30051	0x0032	2 Word	CH9 DI counter value
30053	0x0034	2 Word	CH10 DI counter value
30055	0x0036	2 Word	CH11 DI counter value
30057	0x0038	2 Word	CH12 DI counter value

Reference	Address	Data Type	Description
30059	0x003A	2 Word	CH13 DI counter value
30061	0x003C	2 Word	CH14 DI counter value
30063	0x003E	2 Word	CH15 DI counter value

4xxxx Read/Write Registers (Functions 3, 6, 16)

Reference	Address	Data Type	Description
40001	0x0000	1 Word	CH0 DI Mode, 0=DI, 1=Counter
40002	0x0001	1 Word	CH1 DI Mode, 0=DI, 1=Counter
40003	0x0002	1 Word	CH2 DI Mode, 0=DI, 1=Counter
40004	0x0003	1 Word	CH3 DI Mode, 0=DI, 1=Counter
40005	0x0004	1 Word	CH4 DI Mode, 0=DI, 1=Counter
40006	0x0005	1 Word	CH5 DI Mode, 0=DI, 1=Counter
40007	0x0006	1 Word	CH6 DI Mode, 0=DI, 1=Counter
40008	0x0007	1 Word	CH7 DI Mode, 0=DI, 1=Counter
40009	0x0008	1 Word	CH8 DI Mode, 0=DI, 1=Counter
40010	0x0009	1 Word	CH9 DI Mode, 0=DI, 1=Counter
40011	0x000A	1 Word	CH10 DI Mode, 0=DI, 1=Counter
40012	0x000B	1 Word	CH11 DI Mode, 0=DI, 1=Counter
40013	0x000C	1 Word	CH12 DI Mode, 0=DI, 1=Counter
40014	0x000D	1 Word	CH13 DI Mode, 0=DI, 1=Counter
40015	0x000E	1 Word	CH14 DI Mode, 0=DI, 1=Counter
40016	0x000F	1 Word	CH15 DI Mode, 0=DI, 1=Counter
40033	0x0020	1 Word	CH0 DI filter value
40034	0x0021	1 Word	CH1 DI filter value
40035	0x0022	1 Word	CH2 DI filter value
40036	0x0023	1 Word	CH3 DI filter value
40037	0x0024	1 Word	CH4 DI filter value
40038	0x0025	1 Word	CH5 DI filter value
40039	0x0026	1 Word	CH6 DI filter value
40040	0x0027	1 Word	CH7 DI filter value
40041	0x0028	1 Word	CH8 DI filter value
40042	0x0029	1 Word	CH9 DI filter value
40043	0x002A	1 Word	CH10 DI filter value
40044	0x002B	1 Word	CH11 DI filter value
40045	0x002C	1 Word	CH12 DI filter value
40046	0x002D	1 Word	CH13 DI filter value
40047	0x002E	1 Word	CH14 DI filter value
40048	0x002F	1 Word	CH15 DI filter value
40065	0x0040	1 Word	CH0 DI counter trigger type, 0:L2H, 1:H2L, 2: Both
40066	0x0041	1 Word	CH1 DI counter trigger type, 0:L2H, 1:H2L, 2: Both
40067	0x0042	1 Word	CH2 DI counter trigger type, 0:L2H, 1:H2L, 2: Both
40068	0x0043	1 Word	CH3 DI counter trigger type, 0:L2H, 1:H2L, 2: Both
40069	0x0044	1 Word	CH4 DI counter trigger type, 0:L2H, 1:H2L, 2: Both
40070	0x0045	1 Word	CH5 DI counter trigger type, 0:L2H, 1:H2L, 2: Both
40071	0x0046	1 Word	CH6 DI counter trigger type, 0:L2H, 1:H2L, 2: Both
40072	0x0047	1 Word	CH7 DI counter trigger type, 0:L2H, 1:H2L, 2: Both
40073	0x0048	1 Word	CH8 DI counter trigger type, 0:L2H, 1:H2L, 2: Both
40074	0x0049	1 Word	CH9 DI counter trigger type, 0:L2H, 1:H2L, 2: Both
40075	0x004A	1 Word	CH10 DI counter trigger type, 0:L2H, 1:H2L, 2: Both
40076	0x004B	1 Word	CH11 DI counter trigger type, 0:L2H, 1:H2L, 2: Both

Reference	Address	Data Type	Description
40077	0x004C	1 Word	CH12 DI counter trigger type, 0:L2H, 1:H2L, 2: Both
40078	0x004D	1 Word	CH13 DI counter trigger type, 0:L2H, 1:H2L, 2: Both
40079	0x004E	1 Word	CH14 DI counter trigger type, 0:L2H, 1:H2L, 2: Both
40080	0x004F	1 Word	CH15 DI counter trigger type, 0:L2H, 1:H2L, 2: Both

R1212 Modbus Mapping

0xxxx Read/Write Coils (Functions 1, 5, 15)

Reference	Address	Data Type	Description
00001	0x0000	1Bit	CH0 DI Counter start, 0=OFF, 1=ON
00002	0x0001	1Bit	CH1 DI Counter start, 0=OFF, 1=ON
00003	0x0002	1Bit	CH2 DI Counter start, 0=OFF, 1=ON
00004	0x0003	1Bit	CH3 DI Counter start, 0=OFF, 1=ON
00005	0x0004	1Bit	CH4 DI Counter start, 0=OFF, 1=ON
00006	0x0005	1Bit	CH5 DI Counter start, 0=OFF, 1=ON
00007	0x0006	1Bit	CH6 DI Counter start, 0=OFF, 1=ON
00008	0x0007	1Bit	CH7 DI Counter start, 0=OFF, 1=ON
00009	0x0008	1Bit	CH8 DI Counter start, 0=OFF, 1=ON
00010	0x0009	1Bit	CH9 DI Counter start, 0=OFF, 1=ON
00011	0x000A	1Bit	CH10 DI Counter start, 0=OFF, 1=ON
00012	0x000B	1Bit	CH11 DI Counter start, 0=OFF, 1=ON
00013	0x000C	1Bit	CH12 DI Counter start, 0=OFF, 1=ON
00014	0x000D	1Bit	CH13 DI Counter start, 0=OFF, 1=ON
00015	0x000E	1Bit	CH14 DI Counter start, 0=OFF, 1=ON
00016	0x000F	1Bit	CH15 DI Counter start, 0=OFF, 1=ON
00033	0x0020	1Bit	CH0 DI Counter reset, 0=no effect, 1=reset
00034	0x0021	1Bit	CH1 DI Counter reset, 0=no effect, 1=reset
00035	0x0022	1Bit	CH2 DI Counter reset, 0=no effect, 1=reset
00036	0x0023	1Bit	CH3 DI Counter reset, 0=no effect, 1=reset
00037	0x0024	1Bit	CH4 DI Counter reset, 0=no effect, 1=reset
00038	0x0025	1Bit	CH5 DI Counter reset, 0=no effect, 1=reset
00039	0x0026	1Bit	CH6 DI Counter reset, 0=no effect, 1=reset
00040	0x0027	1Bit	CH7 DI Counter reset, 0=no effect, 1=reset
00041	0x0028	1Bit	CH8 DI Counter reset, 0=no effect, 1=reset
00042	0x0029	1Bit	CH9 DI Counter reset, 0=no effect, 1=reset
00043	0x002A	1Bit	CH10 DI Counter reset, 0=no effect, 1=reset
00044	0x002B	1Bit	CH11 DI Counter reset, 0=no effect, 1=reset
00045	0x002C	1Bit	CH12 DI Counter reset, 0=no effect, 1=reset
00046	0x002D	1Bit	CH13 DI Counter reset, 0=no effect, 1=reset
00047	0x002E	1Bit	CH14 DI Counter reset, 0=no effect, 1=reset
00048	0x002F	1Bit	CH15 DI Counter reset, 0=no effect, 1=reset
00065	0x0040	1Bit	CH0 DI Counter overflow, 0=no effect, 1=overflow
00066	0x0041	1Bit	CH1 DI Counter overflow, 0=no effect, 1=overflow
00067	0x0042	1Bit	CH2 DI Counter overflow, 0=no effect, 1=overflow
00068	0x0043	1Bit	CH3 DI Counter overflow, 0=no effect, 1=overflow
00069	0x0044	1Bit	CH4 DI Counter overflow, 0=no effect, 1=overflow
00070	0x0045	1Bit	CH5 DI Counter overflow, 0=no effect, 1=overflow
00071	0x0046	1Bit	CH6 DI Counter overflow, 0=no effect, 1=overflow
00072	0x0047	1Bit	CH7 DI Counter overflow, 0=no effect, 1=overflow

Reference	Address	Data Type	Description
00073	0x0048	1Bit	CH8 DI Counter overflow, 0=no effect, 1=overflow
00074	0x0049	1Bit	CH9 DI Counter overflow, 0=no effect, 1=overflow
00075	0x004A	1Bit	CH10 DI Counter overflow, 0=no effect, 1=overflow
00076	0x004B	1Bit	CH11 DI Counter overflow, 0=no effect, 1=overflow
00077	0x004C	1Bit	CH12 DI Counter overflow, 0=no effect, 1=overflow
00078	0x004D	1Bit	CH13 DI Counter overflow, 0=no effect, 1=overflow
00079	0x004E	1Bit	CH14 DI Counter overflow, 0=no effect, 1=overflow
00080	0x004F	1Bit	CH15 DI Counter overflow, 0=no effect, 1=overflow
00097	0x0060	1Bit	CH0 DI Power on counter start, 0=OFF, 1=ON
00098	0x0061	1Bit	CH1 DI Power on counter start, 0=OFF, 1=ON
00099	0x0062	1Bit	CH2 DI Power on counter start, 0=OFF, 1=ON
00100	0x0063	1Bit	CH3 DI Power on counter start, 0=OFF, 1=ON
00101	0x0064	1Bit	CH4 DI Power on counter start, 0=OFF, 1=ON
00102	0x0065	1Bit	CH5 DI Power on counter start, 0=OFF, 1=ON
00103	0x0066	1Bit	CH6 DI Power on counter start, 0=OFF, 1=ON
00104	0x0067	1Bit	CH7 DI Power on counter start, 0=OFF, 1=ON
00105	0x0068	1Bit	CH8 DI Power on counter start, 0=OFF, 1=ON
00106	0x0069	1Bit	CH9 DI Power on counter start, 0=OFF, 1=ON
00107	0x006A	1Bit	CH10 DI Power on counter start, 0=OFF, 1=ON
00108	0x006B	1Bit	CH11 DI Power on counter start, 0=OFF, 1=ON
00109	0x006C	1Bit	CH12 DI Power on counter start, 0=OFF, 1=ON
00110	0x006D	1Bit	CH13 DI Power on counter start, 0=OFF, 1=ON
00111	0x006E	1Bit	CH14 DI Power on counter start, 0=OFF, 1=ON
00112	0x006F	1Bit	CH15 DI Power on counter start, 0=OFF, 1=ON
00129	0x0080	1Bit	CH0 DI Safe mode counter start, 0=OFF, 1=ON
00130	0x0081	1Bit	CH1 DI Safe mode counter start, 0=OFF, 1=ON
00131	0x0082	1Bit	CH2 DI Safe mode counter start, 0=OFF, 1=ON
00132	0x0083	1Bit	CH3 DI Safe mode counter start, 0=OFF, 1=ON
00133	0x0084	1Bit	CH4 DI Safe mode counter start, 0=OFF, 1=ON
00134	0x0085	1Bit	CH5 DI Safe mode counter start, 0=OFF, 1=ON
00135	0x0086	1Bit	CH6 DI Safe mode counter start, 0=OFF, 1=ON
00136	0x0087	1Bit	CH7 DI Safe mode counter start, 0=OFF, 1=ON
00137	0x0088	1Bit	CH8 DI Safe mode counter start, 0=OFF, 1=ON
00138	0x0089	1Bit	CH9 DI Safe mode counter start, 0=OFF, 1=ON
00139	0x008A	1Bit	CH10 DI Safe mode counter start, 0=OFF, 1=ON
00140	0x008B	1Bit	CH11 DI Safe mode counter start, 0=OFF, 1=ON
00141	0x008C	1Bit	CH12 DI Safe mode counter start, 0=OFF, 1=ON
00142	0x008D	1Bit	CH13 DI Safe mode counter start, 0=OFF, 1=ON
00143	0x008E	1Bit	CH14 DI Safe mode counter start, 0=OFF, 1=ON
00144	0x008F	1Bit	CH15 DI Safe mode counter start, 0=OFF, 1=ON
00161	0x00A0	1Bit	CH0 DI power failing counter storage, 0=OFF, 1=ON
00162	0x00A1	1Bit	CH1 DI power failing counter storage, 0=OFF, 1=ON
00163	0x00A2	1Bit	CH2 DI power failing counter storage, 0=OFF, 1=ON
00164	0x00A3	1Bit	CH3 DI power failing counter storage, 0=OFF, 1=ON
00165	0x00A4	1Bit	CH4 DI power failing counter storage, 0=OFF, 1=ON
00166	0x00A5	1Bit	CH5 DI power failing counter storage, 0=OFF, 1=ON
00167	0x00A6	1Bit	CH6 DI power failing counter storage, 0=OFF, 1=ON
00168	0x00A7	1Bit	CH7 DI power failing counter storage, 0=OFF, 1=ON
00169	0x00A8	1Bit	CH8 DI power failing counter storage, 0=OFF, 1=ON
00170	0x00A9	1Bit	CH9 DI power failing counter storage, 0=OFF, 1=ON
00171	0x00AA	1Bit	CH10 DI power failing counter storage, 0=OFF, 1=ON
00172	0x00AB	1Bit	CH11 DI power failing counter storage, 0=OFF, 1=ON

Reference	Address	Data Type	Description
00173	0x00AC	1Bit	CH12 DI power failing counter storage, 0=OFF, 1=ON
00174	0x00AD	1Bit	CH13 DI power failing counter storage, 0=OFF, 1=ON
00175	0x00AE	1Bit	CH14 DI power failing counter storage, 0=OFF, 1=ON
00176	0x00AF	1Bit	CH15 DI power failing counter storage, 0=OFF, 1=ON
00321	0x0140	1Bit	CH0 DO Bit value, 0=OFF, 1=ON
00322	0x0141	1Bit	CH1 DO Bit value, 0=OFF, 1=ON
00323	0x0142	1Bit	CH2 DO Bit value, 0=OFF, 1=ON
00324	0x0143	1Bit	CH3 DO Bit value, 0=OFF, 1=ON
00325	0x0144	1Bit	CH4 DO Bit value, 0=OFF, 1=ON
00326	0x0145	1Bit	CH5 DO Bit value, 0=OFF, 1=ON
00327	0x0146	1Bit	CH6 DO Bit value, 0=OFF, 1=ON
00328	0x0147	1Bit	CH7 DO Bit value, 0=OFF, 1=ON
00353	0x0160	1Bit	CH0 DO Power on value, 0=OFF, 1=ON
00354	0x0161	1Bit	CH1 DO Power on value, 0=OFF, 1=ON
00355	0x0162	1Bit	CH2 DO Power on value, 0=OFF, 1=ON
00356	0x0163	1Bit	CH3 DO Power on value, 0=OFF, 1=ON
00357	0x0164	1Bit	CH4 DO Power on value, 0=OFF, 1=ON
00358	0x0165	1Bit	CH5 DO Power on value, 0=OFF, 1=ON
00359	0x0166	1Bit	CH6 DO Power on value, 0=OFF, 1=ON
00360	0x0167	1Bit	CH7 DO Power on value, 0=OFF, 1=ON
00385	0x0180	1Bit	CH0 DO Pulse start, 0=OFF, 1=ON
00386	0x0181	1Bit	CH1 DO Pulse start, 0=OFF, 1=ON
00387	0x0182	1Bit	CH2 DO Pulse start, 0=OFF, 1=ON
00388	0x0183	1Bit	CH3 DO Pulse start, 0=OFF, 1=ON
00389	0x0184	1Bit	CH4 DO Pulse start, 0=OFF, 1=ON
00390	0x0185	1Bit	CH5 DO Pulse start, 0=OFF, 1=ON
00391	0x0186	1Bit	CH6 DO Pulse start, 0=OFF, 1=ON
00392	0x0187	1Bit	CH7 DO Pulse start, 0=OFF, 1=ON
00417	0x01A0	1Bit	CH0 DO Power Pulse start, 0=OFF, 1=ON
00418	0x01A1	1Bit	CH1 DO Power Pulse start, 0=OFF, 1=ON
00419	0x01A2	1Bit	CH2 DO Power Pulse start, 0=OFF, 1=ON
00420	0x01A3	1Bit	CH3 DO Power Pulse start, 0=OFF, 1=ON
00421	0x01A4	1Bit	CH4 DO Power Pulse start, 0=OFF, 1=ON
00422	0x01A5	1Bit	CH5 DO Power Pulse start, 0=OFF, 1=ON
00423	0x01A6	1Bit	CH6 DO Power Pulse start, 0=OFF, 1=ON
00424	0x01A7	1Bit	CH7 DO Power Pulse start, 0=OFF, 1=ON
00449	0x01C0	1Bit	CH0 DO Safe mode Pulse start, 0=OFF, 1=ON
00450	0x01C1	1Bit	CH1 DO Safe mode Pulse start, 0=OFF, 1=ON
00451	0x01C2	1Bit	CH2 DO Safe mode Pulse start, 0=OFF, 1=ON
00452	0x01C3	1Bit	CH3 DO Safe mode Pulse start, 0=OFF, 1=ON
00453	0x01C4	1Bit	CH4 DO Safe mode Pulse start, 0=OFF, 1=ON
00454	0x01C5	1Bit	CH5 DO Safe mode Pulse start, 0=OFF, 1=ON
00455	0x01C6	1Bit	CH6 DO Safe mode Pulse start, 0=OFF, 1=ON
00456	0x01C7	1Bit	CH7 DO Safe mode Pulse start, 0=OFF, 1=ON

1xxxx Read Only Coils (Function 2)

Reference	Address	Data Type	Description
10001	0x0000	1Bit	CH0 DI Bit value, 0=OFF, 1=ON
10002	0x0001	1Bit	CH1 DI Bit value, 0=OFF, 1=ON
10003	0x0002	1Bit	CH2 DI Bit value, 0=OFF, 1=ON
10004	0x0003	1Bit	CH3 DI Bit value, 0=OFF, 1=ON
10005	0x0004	1Bit	CH4 DI Bit value, 0=OFF, 1=ON
10006	0x0005	1Bit	CH5 DI Bit value, 0=OFF, 1=ON
10007	0x0006	1Bit	CH6 DI Bit value, 0=OFF, 1=ON
10008	0x0007	1Bit	CH7 DI Bit value, 0=OFF, 1=ON
10009	0x0008	1Bit	CH8 DI Bit value, 0=OFF, 1=ON
10010	0x0009	1Bit	CH9 DI Bit value, 0=OFF, 1=ON
10011	0x000A	1Bit	CH10 DI Bit value, 0=OFF, 1=ON
10012	0x000B	1Bit	CH11 DI Bit value, 0=OFF, 1=ON
10013	0x000C	1Bit	CH12 DI Bit value, 0=OFF, 1=ON
10014	0x000D	1Bit	CH13 DI Bit value, 0=OFF, 1=ON
10015	0x000E	1Bit	CH14 DI Bit value, 0=OFF, 1=ON
10016	0x000F	1Bit	CH15 DI Bit value, 0=OFF, 1=ON
10289	0x0120	1Bit	CH0 DIO Direction, 0=DI, 1=DO
10290	0x0121	1Bit	CH1 DIO Direction, 0=DI, 1=DO
10291	0x0122	1Bit	CH2 DIO Direction, 0=DI, 1=DO
10292	0x0123	1Bit	CH3 DIO Direction, 0=DI, 1=DO
10293	0x0124	1Bit	CH4 DIO Direction, 0=DI, 1=DO
10294	0x0125	1Bit	CH5 DIO Direction, 0=DI, 1=DO
10295	0x0126	1Bit	CH6 DIO Direction, 0=DI, 1=DO
10296	0x0127	1Bit	CH7 DIO Direction, 0=DI, 1=DO

3xxxx Read Only Registers (Function 4)

Reference	Address	Data Type	Description
30001	0x0000	1 Word	CH0 DI value, 0=OFF, 1=ON
30002	0x0001	1 Word	CH1 DI value, 0=OFF, 1=ON
30003	0x0002	1 Word	CH2 DI value, 0=OFF, 1=ON
30004	0x0003	1 Word	CH3 DI value, 0=OFF, 1=ON
30005	0x0004	1 Word	CH4 DI value, 0=OFF, 1=ON
30006	0x0005	1 Word	CH5 DI value, 0=OFF, 1=ON
30007	0x0006	1 Word	CH6 DI value, 0=OFF, 1=ON
30008	0x0007	1 Word	CH7 DI value, 0=OFF, 1=ON
30009	0x0008	1 Word	CH8 DI value, 0=OFF, 1=ON
30010	0x0009	1 Word	CH9 DI value, 0=OFF, 1=ON
30011	0x000A	1 Word	CH10 DI value, 0=OFF, 1=ON
30012	0x000B	1 Word	CH11 DI value, 0=OFF, 1=ON
30013	0x000C	1 Word	CH12 DI value, 0=OFF, 1=ON
30014	0x000D	1 Word	CH13 DI value, 0=OFF, 1=ON
30015	0x000E	1 Word	CH14 DI value, 0=OFF, 1=ON
30016	0x000F	1 Word	CH15 DI value, 0=OFF, 1=ON
30033	0x0020	2 Word	CH0 DI counter value
30035	0x0022	2 Word	CH1 DI counter value
30037	0x0024	2 Word	CH2 DI counter value
30039	0x0026	2 Word	CH3 DI counter value
30041	0x0028	2 Word	CH4 DI counter value

Reference	Address	Data Type	Description
30043	0x002A	2 Word	CH5 DI counter value
30045	0x002C	2 Word	CH6 DI counter value
30047	0x002E	2 Word	CH7 DI counter value
30049	0x0030	2 Word	CH8 DI counter value
30051	0x0032	2 Word	CH9 DI counter value
30053	0x0034	2 Word	CH10 DI counter value
30055	0x0036	2 Word	CH11 DI counter value
30057	0x0038	2 Word	CH12 DI counter value
30059	0x003A	2 Word	CH13 DI counter value
30061	0x003C	2 Word	CH14 DI counter value
30063	0x003E	2 Word	CH15 DI counter value
30289	0x0120	1 Word	CH0 DIO Direction, 0=DI, 1=DO
30290	0x0121	1 Word	CH1 DIO Direction, 0=DI, 1=DO
30291	0x0122	1 Word	CH2 DIO Direction, 0=DI, 1=DO
30292	0x0123	1 Word	CH3 DIO Direction, 0=DI, 1=DO
30293	0x0124	1 Word	CH4 DIO Direction, 0=DI, 1=DO
30294	0x0125	1 Word	CH5 DIO Direction, 0=DI, 1=DO
30295	0x0126	1 Word	CH6 DIO Direction, 0=DI, 1=DO
30296	0x0127	1 Word	CH7 DIO Direction, 0=DI, 1=DO

4xxxx Read/Write Registers (Functions 3, 6, 16)

Reference	Address	Data Type	Description
40001	0x0000	1 Word	CH0 DI Mode, 0=DI, 1=Counter
40002	0x0001	1 Word	CH1 DI Mode, 0=DI, 1=Counter
40003	0x0002	1 Word	CH2 DI Mode, 0=DI, 1=Counter
40004	0x0003	1 Word	CH3 DI Mode, 0=DI, 1=Counter
40005	0x0004	1 Word	CH4 DI Mode, 0=DI, 1=Counter
40006	0x0005	1 Word	CH5 DI Mode, 0=DI, 1=Counter
40007	0x0006	1 Word	CH6 DI Mode, 0=DI, 1=Counter
40008	0x0007	1 Word	CH7 DI Mode, 0=DI, 1=Counter
40009	0x0008	1 Word	CH8 DI Mode, 0=DI, 1=Counter
40010	0x0009	1 Word	CH9 DI Mode, 0=DI, 1=Counter
40011	0x000A	1 Word	CH10 DI Mode, 0=DI, 1=Counter
40012	0x000B	1 Word	CH11 DI Mode, 0=DI, 1=Counter
40013	0x000C	1 Word	CH12 DI Mode, 0=DI, 1=Counter
40014	0x000D	1 Word	CH13 DI Mode, 0=DI, 1=Counter
40015	0x000E	1 Word	CH14 DI Mode, 0=DI, 1=Counter
40016	0x000F	1 Word	CH15 DI Mode, 0=DI, 1=Counter
40033	0x0020	1 Word	CH0 DI filter value
40034	0x0021	1 Word	CH1 DI filter value
40035	0x0022	1 Word	CH2 DI filter value
40036	0x0023	1 Word	CH3 DI filter value
40037	0x0024	1 Word	CH4 DI filter value
40038	0x0025	1 Word	CH5 DI filter value
40039	0x0026	1 Word	CH6 DI filter value
40040	0x0027	1 Word	CH7 DI filter value
40041	0x0028	1 Word	CH8 DI filter value
40042	0x0029	1 Word	CH9 DI filter value
40043	0x002A	1 Word	CH10 DI filter value
40044	0x002B	1 Word	CH11 DI filter value

Reference	Address	Data Type	Description
40045	0x002C	1 Word	CH12 DI filter value
40046	0x002D	1 Word	CH13 DI filter value
40047	0x002E	1 Word	CH14 DI filter value
40048	0x002F	1 Word	CH15 DI filter value
40065	0x0040	1 Word	CH0 DI counter trigger type, 0:L2H, 1:H2L, 2: Both
40066	0x0041	1 Word	CH1 DI counter trigger type, 0:L2H, 1:H2L, 2: Both
40067	0x0042	1 Word	CH2 DI counter trigger type, 0:L2H, 1:H2L, 2: Both
40068	0x0043	1 Word	CH3 DI counter trigger type, 0:L2H, 1:H2L, 2: Both
40069	0x0044	1 Word	CH4 DI counter trigger type, 0:L2H, 1:H2L, 2: Both
40070	0x0045	1 Word	CH5 DI counter trigger type, 0:L2H, 1:H2L, 2: Both
40071	0x0046	1 Word	CH6 DI counter trigger type, 0:L2H, 1:H2L, 2: Both
40072	0x0047	1 Word	CH7 DI counter trigger type, 0:L2H, 1:H2L, 2: Both
40073	0x0048	1 Word	CH8 DI counter trigger type, 0:L2H, 1:H2L, 2: Both
40074	0x0049	1 Word	CH9 DI counter trigger type, 0:L2H, 1:H2L, 2: Both
40075	0x004A	1 Word	CH10 DI counter trigger type, 0:L2H, 1:H2L, 2: Both
40076	0x004B	1 Word	CH11 DI counter trigger type, 0:L2H, 1:H2L, 2: Both
40077	0x004C	1 Word	CH12 DI counter trigger type, 0:L2H, 1:H2L, 2: Both
40078	0x004D	1 Word	CH13 DI counter trigger type, 0:L2H, 1:H2L, 2: Both
40079	0x004E	1 Word	CH14 DI counter trigger type, 0:L2H, 1:H2L, 2: Both
40080	0x004F	1 Word	CH15 DI counter trigger type, 0:L2H, 1:H2L, 2: Both
40321	0x0140	1 Word	CH0 DO value, 0=OFF, 1=ON
40322	0x0141	1 Word	CH1 DO value, 0=OFF, 1=ON
40323	0x0142	1 Word	CH2 DO value, 0=OFF, 1=ON
40324	0x0143	1 Word	CH3 DO value, 0=OFF, 1=ON
40325	0x0144	1 Word	CH4 DO value, 0=OFF, 1=ON
40326	0x0145	1 Word	CH5 DO value, 0=OFF, 1=ON
40327	0x0146	1 Word	CH6 DO value, 0=OFF, 1=ON
40328	0x0147	1 Word	CH7 DO value, 0=OFF, 1=ON
40353	0x0160	2 Word	CH0 DO pulse out count
40355	0x0162	2 Word	CH1 DO pulse out count
40357	0x0164	2 Word	CH2 DO pulse out count
40359	0x0166	2 Word	CH3 DO pulse out count
40361	0x0168	2 Word	CH4 DO pulse out count
40363	0x016A	2 Word	CH5 DO pulse out count
40365	0x016C	2 Word	CH6 DO pulse out count
40367	0x016E	2 Word	CH7 DO pulse out count
40417	0x01A0	1 Word	CH0 DO pulse width (ON)
40418	0x01A1	1 Word	CH1 DO pulse width (ON)
40419	0x01A2	1 Word	CH2 DO pulse width (ON)
40420	0x01A3	1 Word	CH3 DO pulse width (ON)
40421	0x01A4	1 Word	CH4 DO pulse width (ON)
40422	0x01A5	1 Word	CH5 DO pulse width (ON)
40423	0x01A6	1 Word	CH6 DO pulse width (ON)
40424	0x01A7	1 Word	CH7 DO pulse width (ON)
40449	0x01C0	1 Word	CH0 DO pulse width (OFF)
40450	0x01C1	1 Word	CH1 DO pulse width (OFF)
40451	0x01C2	1 Word	CH2 DO pulse width (OFF)
40452	0x01C3	1 Word	CH3 DO pulse width (OFF)
40453	0x01C4	1 Word	CH4 DO pulse width (OFF)
40454	0x01C5	1 Word	CH5 DO pulse width (OFF)
40455	0x01C6	1 Word	CH6 DO pulse width (OFF)
40456	0x01C7	1 Word	CH7 DO pulse width (OFF)

Reference	Address	Data Type	Description
40481	0x01E0	1 Word	CH0 DO save mode status, 0: OFF, 1: ON, 3: hold last
40482	0x01E1	1 Word	CH1 DO save mode status, 0: OFF, 1: ON, 3: hold last
40483	0x01E2	1 Word	CH2 DO save mode status, 0: OFF, 1: ON, 3: hold last
40484	0x01E3	1 Word	CH3 DO save mode status, 0: OFF, 1: ON, 3: hold last
40485	0x01E4	1 Word	CH4 DO save mode status, 0: OFF, 1: ON, 3: hold last
40486	0x01E5	1 Word	CH5 DO save mode status, 0: OFF, 1: ON, 3: hold last
40487	0x01E6	1 Word	CH6 DO save mode status, 0: OFF, 1: ON, 3: hold last
40488	0x01E7	1 Word	CH7 DO save mode status, 0: OFF, 1: ON, 3: hold last
40513	0x0200	1 Word	CH0 DO mode, 0: DO, 1: Pulse out
40514	0x0201	1 Word	CH1 DO mode, 0: DO, 1: Pulse out
40515	0x0202	1 Word	CH2 DO mode, 0: DO, 1: Pulse out
40516	0x0203	1 Word	CH3 DO mode, 0: DO, 1: Pulse out
40517	0x0204	1 Word	CH4 DO mode, 0: DO, 1: Pulse out
40518	0x0205	1 Word	CH5 DO mode, 0: DO, 1: Pulse out
40519	0x0206	1 Word	CH6 DO mode, 0: DO, 1: Pulse out
40520	0x0207	1 Word	CH7 DO mode, 0: DO, 1: Pulse out

R1214 Modbus Mapping

0xxxx Read/Write Coils (Functions 1, 5, 15)

Reference	Address	Data Type	Description
00001	0x0000	1Bit	CH0 DI Counter start, 0=OFF, 1=ON
00002	0x0001	1Bit	CH1 DI Counter start, 0=OFF, 1=ON
00003	0x0002	1Bit	CH2 DI Counter start, 0=OFF, 1=ON
00004	0x0003	1Bit	CH3 DI Counter start, 0=OFF, 1=ON
00005	0x0004	1Bit	CH4 DI Counter start, 0=OFF, 1=ON
00006	0x0005	1Bit	CH5 DI Counter start, 0=OFF, 1=ON
00033	0x0020	1Bit	CH0 DI Counter reset, 0=no effect, 1=reset
00034	0x0021	1Bit	CH1 DI Counter reset, 0=no effect, 1=reset
00035	0x0022	1Bit	CH2 DI Counter reset, 0=no effect, 1=reset
00036	0x0023	1Bit	CH3 DI Counter reset, 0=no effect, 1=reset
00037	0x0024	1Bit	CH4 DI Counter reset, 0=no effect, 1=reset
00038	0x0025	1Bit	CH5 DI Counter reset, 0=no effect, 1=reset
00065	0x0040	1Bit	CH0 DI Counter overflow, 0=no effect, 1=overflow
00066	0x0041	1Bit	CH1 DI Counter overflow, 0=no effect, 1=overflow
00067	0x0042	1Bit	CH2 DI Counter overflow, 0=no effect, 1=overflow
00068	0x0043	1Bit	CH3 DI Counter overflow, 0=no effect, 1=overflow
00069	0x0044	1Bit	CH4 DI Counter overflow, 0=no effect, 1=overflow
00070	0x0045	1Bit	CH5 DI Counter overflow, 0=no effect, 1=overflow
00097	0x0060	1Bit	CH0 DI Power on counter start, 0=OFF, 1=ON
00098	0x0061	1Bit	CH1 DI Power on counter start, 0=OFF, 1=ON
00099	0x0062	1Bit	CH2 DI Power on counter start, 0=OFF, 1=ON
00100	0x0063	1Bit	CH3 DI Power on counter start, 0=OFF, 1=ON
00101	0x0064	1Bit	CH4 DI Power on counter start, 0=OFF, 1=ON
00102	0x0065	1Bit	CH5 DI Power on counter start, 0=OFF, 1=ON
00129	0x0080	1Bit	CH0 DI Safe mode counter start, 0=OFF, 1=ON
00130	0x0081	1Bit	CH1 DI Safe mode counter start, 0=OFF, 1=ON
00131	0x0082	1Bit	CH2 DI Safe mode counter start, 0=OFF, 1=ON
00132	0x0083	1Bit	CH3 DI Safe mode counter start, 0=OFF, 1=ON

Reference	Address	Data Type	Description
00133	0x0084	1Bit	CH4 DI Safe mode counter start, 0=OFF, 1=ON
00134	0x0085	1Bit	CH5 DI Safe mode counter start, 0=OFF, 1=ON
00161	0x00A0	1Bit	CH0 DI power failing counter storage, 0=OFF, 1=ON
00162	0x00A1	1Bit	CH1 DI power failing counter storage, 0=OFF, 1=ON
00163	0x00A2	1Bit	CH2 DI power failing counter storage, 0=OFF, 1=ON
00164	0x00A3	1Bit	CH3 DI power failing counter storage, 0=OFF, 1=ON
00165	0x00A4	1Bit	CH4 DI power failing counter storage, 0=OFF, 1=ON
00166	0x00A5	1Bit	CH5 DI power failing counter storage, 0=OFF, 1=ON
00321	0x0140	1Bit	CH0 Relay Bit value, 0=OFF, 1=ON
00322	0x0141	1Bit	CH1 Relay Bit value, 0=OFF, 1=ON
00323	0x0142	1Bit	CH2 Relay Bit value, 0=OFF, 1=ON
00324	0x0143	1Bit	CH3 Relay Bit value, 0=OFF, 1=ON
00325	0x0144	1Bit	CH4 Relay Bit value, 0=OFF, 1=ON
00326	0x0145	1Bit	CH5 Relay Bit value, 0=OFF, 1=ON
00353	0x0160	1Bit	CH0 Relay Power on value, 0=OFF, 1=ON
00354	0x0161	1Bit	CH1 Relay Power on value, 0=OFF, 1=ON
00355	0x0162	1Bit	CH2 Relay Power on value, 0=OFF, 1=ON
00356	0x0163	1Bit	CH3 Relay Power on value, 0=OFF, 1=ON
00357	0x0164	1Bit	CH4 Relay Power on value, 0=OFF, 1=ON
00358	0x0165	1Bit	CH5 Relay Power on value, 0=OFF, 1=ON
00385	0x0180	1Bit	CH0 Relay Pulse start, 0=OFF, 1=ON
00386	0x0181	1Bit	CH1 Relay Pulse start, 0=OFF, 1=ON
00387	0x0182	1Bit	CH2 Relay Pulse start, 0=OFF, 1=ON
00388	0x0183	1Bit	CH3 Relay Pulse start, 0=OFF, 1=ON
00389	0x0184	1Bit	CH4 Relay Pulse start, 0=OFF, 1=ON
00390	0x0185	1Bit	CH5 Relay Pulse start, 0=OFF, 1=ON
00417	0x01A0	1Bit	CH0 Relay Power Pulse start, 0=OFF, 1=ON
00418	0x01A1	1Bit	CH1 Relay Power Pulse start, 0=OFF, 1=ON
00419	0x01A2	1Bit	CH2 Relay Power Pulse start, 0=OFF, 1=ON
00420	0x01A3	1Bit	CH3 Relay Power Pulse start, 0=OFF, 1=ON
00421	0x01A4	1Bit	CH4 Relay Power Pulse start, 0=OFF, 1=ON
00422	0x01A5	1Bit	CH5 Relay Power Pulse start, 0=OFF, 1=ON
00449	0x01C0	1Bit	CH0 Relay Safe mode Pulse start, 0=OFF, 1=ON
00450	0x01C1	1Bit	CH1 Relay Safe mode Pulse start, 0=OFF, 1=ON
00451	0x01C2	1Bit	CH2 Relay Safe mode Pulse start, 0=OFF, 1=ON
00452	0x01C3	1Bit	CH3 Relay Safe mode Pulse start, 0=OFF, 1=ON
00453	0x01C4	1Bit	CH4 Relay Safe mode Pulse start, 0=OFF, 1=ON
00454	0x01C5	1Bit	CH5 Relay Safe mode Pulse start, 0=OFF, 1=ON
00480	0x01E0	1Bit	CH0 Relay reset user relay counter, 1= reset
00481	0x01E0	1Bit	CH1 Relay reset user relay counter, 1= reset
00482	0x01E0	1Bit	CH2 Relay reset user relay counter, 1= reset
00483	0x01E0	1Bit	CH3 Relay reset user relay counter, 1= reset
00484	0x01E0	1Bit	CH4 Relay reset user relay counter, 1= reset
00485	0x01E0	1Bit	CH5 Relay reset user relay counter, 1= reset

1xxxx Read Only Coils (Function 2)

Reference	Address	Data Type	Description
10001	0x0000	1Bit	CH0 DI Bit value, 0=OFF, 1=ON
10002	0x0001	1Bit	CH1 DI Bit value, 0=OFF, 1=ON
10003	0x0002	1Bit	CH2 DI Bit value, 0=OFF, 1=ON
10004	0x0003	1Bit	CH3 DI Bit value, 0=OFF, 1=ON
10005	0x0004	1Bit	CH4 DI Bit value, 0=OFF, 1=ON
10006	0x0005	1Bit	CH5 DI Bit value, 0=OFF, 1=ON

3xxxx Read Only Registers (Function 4)

Reference	Address	Data Type	Description
30001	0x0000	1 Word	CH0 DI value, 0=OFF, 1=ON
30002	0x0001	1 Word	CH1 DI value, 0=OFF, 1=ON
30003	0x0002	1 Word	CH2 DI value, 0=OFF, 1=ON
30004	0x0003	1 Word	CH3 DI value, 0=OFF, 1=ON
30005	0x0004	1 Word	CH4 DI value, 0=OFF, 1=ON
30006	0x0005	1 Word	CH5 DI value, 0=OFF, 1=ON
30033	0x0020	2 Word	CH0 DI counter value
30035	0x0022	2 Word	CH1 DI counter value
30037	0x0024	2 Word	CH2 DI counter value
30039	0x0026	2 Word	CH3 DI counter value
30041	0x0028	2 Word	CH4 DI counter value
30043	0x002A	2 Word	CH5 DI counter value
30321	0x0140	2 Word	CH0 Relay total count
30323	0x0142	2 Word	CH1 Relay total count
30325	0x0144	2 Word	CH2 Relay total count
30327	0x0146	2 Word	CH3 Relay total count
30329	0x0148	2 Word	CH4 Relay total count
30331	0x014A	2 Word	CH5 Relay total count
30385	0x0180	2 Word	CH0 Relay user count
30387	0x0182	2 Word	CH1 Relay user count
30389	0x0184	2 Word	CH2 Relay user count
30391	0x0186	2 Word	CH3 Relay user count
30393	0x0188	2 Word	CH4 Relay user count
30395	0x018A	2 Word	CH5 Relay user count

4xxxx Read/Write Registers (Functions 3, 6, 16)

Reference	Address	Data Type	Description
40001	0x0000	1 Word	CH0 DI Mode, 0=DI, 1=Counter
40002	0x0001	1 Word	CH1 DI Mode, 0=DI, 1=Counter
40003	0x0002	1 Word	CH2 DI Mode, 0=DI, 1=Counter
40004	0x0003	1 Word	CH3 DI Mode, 0=DI, 1=Counter
40005	0x0004	1 Word	CH4 DI Mode, 0=DI, 1=Counter
40006	0x0005	1 Word	CH5 DI Mode, 0=DI, 1=Counter
40033	0x0020	1 Word	CH0 DI filter value
40034	0x0021	1 Word	CH1 DI filter value
40035	0x0022	1 Word	CH2 DI filter value
40036	0x0023	1 Word	CH3 DI filter value
40037	0x0024	1 Word	CH4 DI filter value

Reference	Address	Data Type	Description
40038	0x0025	1 Word	CH5 DI filter value
40065	0x0040	1 Word	CH0 DI counter trigger type, 0:L2H, 1:H2L, 2: Both
40066	0x0041	1 Word	CH1 DI counter trigger type, 0:L2H, 1:H2L, 2: Both
40067	0x0042	1 Word	CH2 DI counter trigger type, 0:L2H, 1:H2L, 2: Both
40068	0x0043	1 Word	CH3 DI counter trigger type, 0:L2H, 1:H2L, 2: Both
40069	0x0044	1 Word	CH4 DI counter trigger type, 0:L2H, 1:H2L, 2: Both
40070	0x0045	1 Word	CH5 DI counter trigger type, 0:L2H, 1:H2L, 2: Both
40321	0x0140	1 Word	CH0 Relay value, 0=OFF, 1=ON
40322	0x0141	1 Word	CH1 Relay value, 0=OFF, 1=ON
40323	0x0142	1 Word	CH2 Relay value, 0=OFF, 1=ON
40324	0x0143	1 Word	CH3 Relay value, 0=OFF, 1=ON
40325	0x0144	1 Word	CH4 Relay value, 0=OFF, 1=ON
40326	0x0145	1 Word	CH5 Relay value, 0=OFF, 1=ON
40353	0x0160	2 Word	CH0 Relay pulse out count
40355	0x0162	2 Word	CH1 Relay pulse out count
40357	0x0164	2 Word	CH2 Relay pulse out count
40359	0x0166	2 Word	CH3 Relay pulse out count
40361	0x0168	2 Word	CH4 Relay pulse out count
40363	0x016A	2 Word	CH5 Relay pulse out count
40545	0x0220	1 Word	CH0 Relay power on delay
40546	0x0221	1 Word	CH1 Relay power on delay
40547	0x0222	1 Word	CH2 Relay power on delay
40548	0x0223	1 Word	CH3 Relay power on delay
40549	0x0224	1 Word	CH4 Relay power on delay
40550	0x0225	1 Word	CH5 Relay power on delay

R1240 Modbus Mapping

0xxxx Read/Write Coils (Functions 1, 5, 15)

Reference	Address	Data Type	Description
00705	0x02C0	1Bit	CH0 AI reset min value counter, 1= reset
00706	0x02C1	1Bit	CH1 AI reset min value counter, 1= reset
00707	0x02C2	1Bit	CH2 AI reset min value counter, 1= reset
00708	0x02C3	1Bit	CH3 AI reset min value counter, 1= reset
00709	0x02C4	1Bit	CH4 AI reset min value counter, 1= reset
00710	0x02C5	1Bit	CH5 AI reset min value counter, 1= reset
00711	0x02C6	1Bit	CH6 AI reset min value counter, 1= reset
00712	0x02C7	1Bit	CH7 AI reset min value counter, 1= reset
00737	0x02E0	1Bit	CH0 AI reset max value counter, 1= reset
00738	0x02E1	1Bit	CH1 AI reset max value counter, 1= reset
00739	0x02E2	1Bit	CH2 AI reset max value counter, 1= reset
00740	0x02E3	1Bit	CH3 AI reset max value counter, 1= reset
00741	0x02E4	1Bit	CH4 AI reset max value counter, 1= reset
00742	0x02E5	1Bit	CH5 AI reset max value counter, 1= reset
00743	0x02E6	1Bit	CH6 AI reset max value counter, 1= reset
00744	0x02E7	1Bit	CH7 AI reset max value counter, 1= reset

3xxxx Read Only Registers (Function 4)

Reference	Address	Data Type	Description
30705	0x02C0	1 Word	CH0 AI raw value
30706	0x02C1	1 Word	CH1 AI raw value
30707	0x02C2	1 Word	CH2 AI raw value
30708	0x02C3	1 Word	CH3 AI raw value
30709	0x02C4	1 Word	CH4 AI raw value
30710	0x02C5	1 Word	CH5 AI raw value
30711	0x02C6	1 Word	CH6 AI raw value
30712	0x02C7	1 Word	CH7 AI raw value
30737	0x02E0	1 Word	CH0 AI min raw value
30738	0x02E1	1 Word	CH1 AI min raw value
30739	0x02E2	1 Word	CH2 AI min raw value
30740	0x02E3	1 Word	CH3 AI min raw value
30741	0x02E4	1 Word	CH4 AI min raw value
30742	0x02E5	1 Word	CH5 AI min raw value
30743	0x02E6	1 Word	CH6 AI min raw value
30744	0x02E7	1 Word	CH7 AI min raw value
30769	0x0300	1 Word	CH0 AI max raw value
30770	0x0301	1 Word	CH1 AI max raw value
30771	0x0302	1 Word	CH2 AI max raw value
30772	0x0303	1 Word	CH3 AI max raw value
30773	0x0304	1 Word	CH4 AI max raw value
30774	0x0305	1 Word	CH5 AI max raw value
30775	0x0306	1 Word	CH6 AI max raw value
30776	0x0307	1 Word	CH7 AI max raw value
30801	0x0320	2 Word	CH0 AI value (eng. data)
30803	0x0322	2 Word	CH1 AI value (eng. data)
30805	0x0324	2 Word	CH2 AI value (eng. data)
30807	0x0326	2 Word	CH3 AI value (eng. data)
30809	0x0328	2 Word	CH4 AI value (eng. data)
30811	0x032A	2 Word	CH5 AI value (eng. data)
30813	0x032C	2 Word	CH6 AI value (eng. data)
30815	0x032E	2 Word	CH7 AI value (eng. data)
30865	0x0360	2 Word	CH0 AI min value (eng. data)
30867	0x0362	2 Word	CH1 AI min value (eng. data)
30869	0x0364	2 Word	CH2 AI min value (eng. data)
30871	0x0366	2 Word	CH3 AI min value (eng. data)
30873	0x0368	2 Word	CH4 AI min value (eng. data)
30875	0x036A	2 Word	CH5 AI min value (eng. data)
30877	0x036C	2 Word	CH6 AI min value (eng. data)
30879	0x036E	2 Word	CH7 AI min value (eng. data)
30929	0x03A0	2 Word	CH0 AI max value (eng. data)
30931	0x03A2	2 Word	CH1 AI max value (eng. data)
30933	0x03A4	2 Word	CH2 AI max value (eng. data)
30935	0x03A6	2 Word	CH3 AI max value (eng. data)
30937	0x03A8	2 Word	CH4 AI max value (eng. data)
30939	0x03AA	2 Word	CH5 AI max value (eng. data)
30941	0x03AC	2 Word	CH6 AI max value (eng. data)
30943	0x03AE	2 Word	CH7 AI max value (eng. data)
30993	0x03E0	1 Word	CH0 AI status, 0: normal, 1: burnout, 2: over-ranged,

Reference	Address	Data Type	Description
			3: under-ranged
30994	0x03E1	1 Word	CH1 AI status, 0: normal, 1: burnout, 2: over-ranged, 3: under-ranged
30995	0x03E2	1 Word	CH2 AI status, 0: normal, 1: burnout, 2: over-ranged, 3: under-ranged
30996	0x03E3	1 Word	CH3 AI status, 0: normal, 1: burnout, 2: over-ranged, 3: under-ranged
30997	0x03E4	1 Word	CH4 AI status, 0: normal, 1: burnout, 2: over-ranged, 3: under-ranged
30998	0x03E5	1 Word	CH5 AI status, 0: normal, 1: burnout, 2: over-ranged, 3: under-ranged
30999	0x03E6	1 Word	CH6 AI status, 0: normal, 1: burnout, 2: over-ranged, 3: under-ranged
31000	0x03E7	1 Word	CH7 AI status, 0: normal, 1: burnout, 2: over-ranged, 3: under-ranged

4xxxx Read/Write Registers (Functions 3, 6, 16)

Reference	Address	Data Type	Description
40705	0x02C0	1 Word	CH0 AI range, 0: 0-10V, 1: 0-20 mA, 2: 4-20 mA burnout
40706	0x02C1	1 Word	CH1 AI range, 0: 0-10V, 1: 0-20 mA, 2: 4-20 mA burnout
40707	0x02C2	1 Word	CH2 AI range, 0: 0-10V, 1: 0-20 mA, 2: 4-20 mA burnout
40708	0x02C3	1 Word	CH3 AI range, 0: 0-10V, 1: 0-20 mA, 2: 4-20 mA burnout
40709	0x02C4	1 Word	CH4 AI range, 0: 0-10V, 1: 0-20 mA, 2: 4-20 mA burnout
40710	0x02C5	1 Word	CH5 AI range, 0: 0-10V, 1: 0-20 mA, 2: 4-20 mA burnout
40711	0x02C6	1 Word	CH6 AI range, 0: 0-10V, 1: 0-20 mA, 2: 4-20 mA burnout
40712	0x02C7	1 Word	CH7 AI range, 0: 0-10V, 1: 0-20 mA, 2: 4-20 mA burnout
40737	0x02E0	2 Word	CH0 AI burnout value (float)
40739	0x02E2	2 Word	CH1 AI burnout value (float)
40741	0x02E4	2 Word	CH2 AI burnout value (float)
40743	0x02E6	2 Word	CH3 AI burnout value (float)
40745	0x02E8	2 Word	CH4 AI burnout value (float)
40747	0x02EA	2 Word	CH5 AI burnout value (float)
40749	0x02EC	2 Word	CH6 AI burnout value (float)
40751	0x02EE	2 Word	CH7 AI burnout value (float)

R1241 Modbus Mapping

4xxxx Read/Write Registers (Functions 3, 6, 16)

Reference	Address	Data Type	Description
41185	0x04A0	1 Word	CH0 AO raw value (0 to 4095)
41186	0x04A1	1 Word	CH1 AO raw value (0 to 4095)
41187	0x04A2	1 Word	CH2 AO raw value (0 to 4095)
41188	0x04A3	1 Word	CH3 AO raw value (0 to 4095)
41217	0x04C0	1 Word	CH0 AO power on raw value (0 to 4095)
41218	0x04C1	1 Word	CH1 AO power on raw value (0 to 4095)
41219	0x04C2	1 Word	CH2 AO power on raw value (0 to 4095)
41220	0x04C3	1 Word	CH3 AO power on raw value (0 to 4095)
41249	0x04E0	1 Word	CH0 AO safe mode raw value (0 to 4095)
41250	0x04E1	1 Word	CH1 AO safe mode raw value (0 to 4095)
41251	0x04E2	1 Word	CH2 AO safe mode raw value (0 to 4095)
41252	0x04E3	1 Word	CH3 AO safe mode raw value (0 to 4095)
41281	0x0500	1 Word	CH0 AO range, 0: 0-10V, 1:0-20mA
41282	0x0501	1 Word	CH1 AO range, 0: 0-10V, 1:0-20mA
41283	0x0502	1 Word	CH2 AO range, 0: 0-10V, 1:0-20mA
41284	0x0503	1 Word	CH3 AO range, 0: 0-10V, 1:0-20mA

B

Factory Defaults

The ioLogik R1200 series comes configured with the following factory default settings:

Baudrate	9600
Data Bits	8
Parity	None
Stop Bits	1
Watchdog	Disable
Watchdog Time Out	10 seconds
Server Name	Blank
Server Location	Blank
DI Mode	DI
Filter Time	100 ms
Trigger for Counter	Lo to Hi
Counter Status	Stop
DO Mode	DO
DO Safe Status	Disable
Power On Status	Disable
Low Width for Pulses	1 ms (1.5 s for relay)
High Width for Pulses	1 ms (1.5 s for relay)
Output Pulses	0 (continuous)
DIO Mode	DO
AI Mode	Voltage
Scaling and Slop-Intercept	Disable
AO Mode	Voltage
Scaling	Disable

C

Pinouts

R1210
(top to bottom)

1	COM 0	
2	DI0	
3	DI1	
4	DI2	
5	DI3	
6	GND	
7	DI4	
8	DI5	
9	DI6	
10	DI7	
11	COM 1	
12	DI8	
13	DI9	
14	DI10	
15	DI11	
16	GND	
17	DI12	
18	DI13	
19	DI14	
20	DI15	

R1212
(top to bottom)

1	COM0	
2	DI0	
3	DI1	
4	DI2	
5	DI3	
6	GND	
7	DI4	
8	DI5	
9	DI6	
10	DI7	
11	COM1	
12	DIO0	
13	DIO1	
14	DIO2	
15	DIO3	
16	GND	
17	DIO4	
18	DIO5	
19	DIO6	
20	DIO7	

R1214
(top to bottom)

1	COM	
2	DI0	
3	DI1	
4	DI2	
5	DI3	
6	DI4	
7	DI5	
8	GND	
9	R0_NO	
10	R0_C	
11	R1_NO	
12	R1_C	
13	R2_NO	
14	R2_C	
15	R3_NO	
16	R3_C	
17	R4_NO	
18	R4_C	
19	R5_NO	
20	R5_C	

R1240
(top to bottom)

1	AI0+	
2	AI0-	
3	AI1+	
4	AI1-	
5	AI2+	
6	AI2-	
7	AI3+	
8	AI3-	
9	AI4+	
10	AI4-	
11	AI5+	
12	AI5-	
13	AI6+	
14	AI6-	
15	AI7+	
16	AI7-	
17		
18		
19		
20		

R1241
(top to bottom)

1	VO0+	
2	VO0-	
3	IO0+	
4	IO0-	
5	VO1+	
6	VO1-	
7	IO1+	
8	IO1-	
9	VO2+	
10	VO2-	
11	IO2+	
12	IO2-	
13	VO3+	
14	VO3-	
15	IO3+	
16	IO3-	
17		
18		
19	EX_V	
20	EX_C	

D

FCC Interference Statement

Federal Communication Commission Warning

This equipment has been tested and found to comply with the limits for a Class A digital device, pursuant to part 15 of the FCC Rules. Operation is subject to the following two conditions: (1) This device may not cause harmful interference, and (2) this device must accept any interference received, including interference that may cause undesired operation.

These limits are designed to provide reasonable protection against harmful interference when the equipment is operated in a commercial environment. This equipment generates, uses, and can radiate radio frequency energy and, if not installed and used in accordance with the instruction manual, may cause harmful interference to radio communications. Operation of this equipment in a residential area is likely to cause harmful interference in which case the user will be required to correct the interference at his own expense.

E

European Community (CE)

This is a Class A product. In a domestic environment, this product may cause radio interference in which case the user may be required to take adequate measures.